

SPECIFICATIONS

Features/Benefits



- Requires Gerber Treysta® Rough-In, G00GS50 Series (Horizontal Inputs) or G00GS52 Series (Vertical Inputs), Sold Separately
- Includes Treysta® Ceramic Disc Pressure Balance Cartridge
- 6" Metal Shower Arm (D510558LSTC Only)
- Finish-Matched Deep Wall Kit, D113001, Sold Separately
- Finish-Matched Shallow Wall Kit, GA663B11, Sold Separately



Available Color/Finishes

Color	Description
-------	-------------

	Chrome
---	--------

Please see gerberonline.com or current price list for available finishes. Finish is defined by additional suffix.

Standards & Certifications



Flow Rate

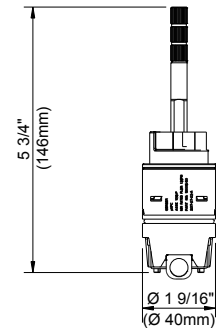
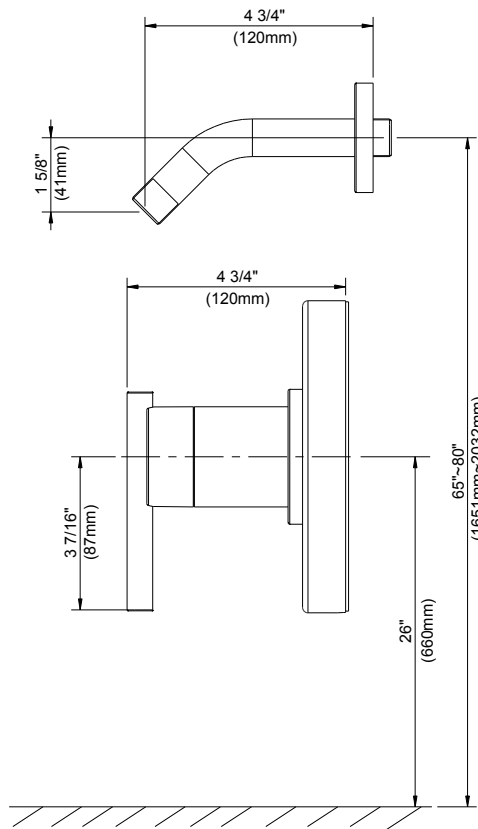
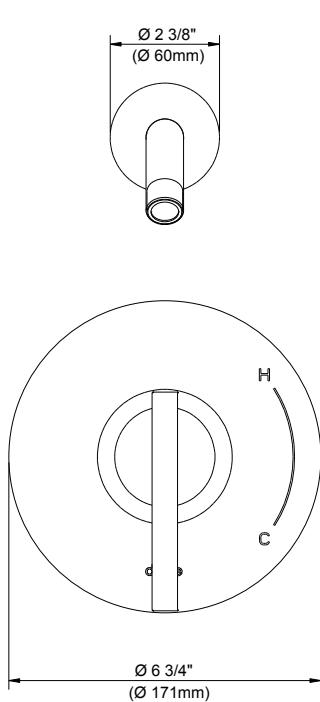
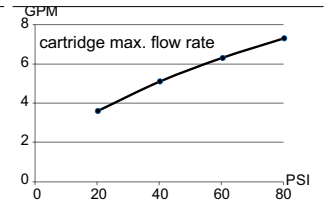

Submittal Information:

Name: _____

Contractor: _____

Location: _____

Contact #: _____