

SPECIFICATIONS



Features/Benefits

- Diverter on Valve
- Requires Gerber Treysta® Rough-In, G00GS55 Series with Diverter On Valve, Sold Separately
- Includes Treysta® Ceramic Disc Pressure Balance Cartridge
- 12" Metal Shower Arm, D481376 (D502157LSTC Only)
- 6" Tub Spout DA666573 (D502157LSTC Only)
- Finish-Matched Deep Wall Kit, D113001, Sold Separately
- Finish-Matched Shallow Wall Kit, GA663B11, Sold Separately

Available Color/Finishes

Color tiles intended for reference only.

Color	Code	Description
		Chrome
	BN	Brushed Nickel
	BS	Satin Black

Standards & Certifications

ASME A112.18.1/CSA B125.1
ADA for lever handle control

Flow Rate

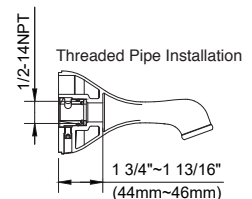
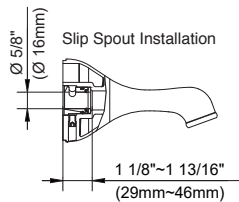
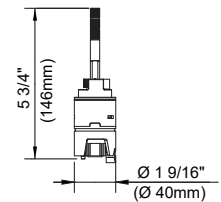
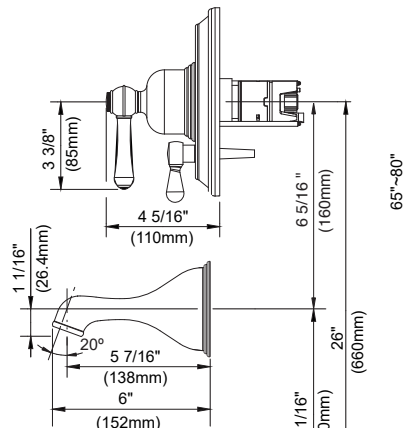
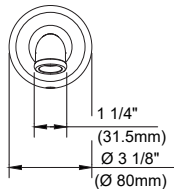
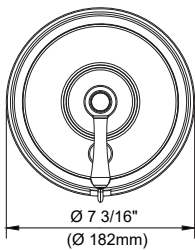
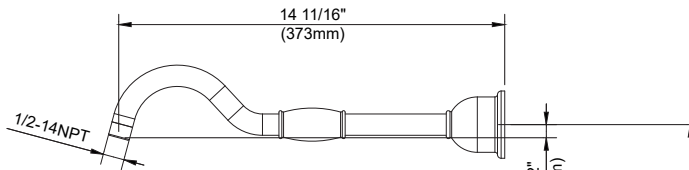
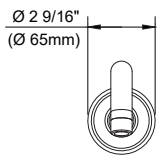
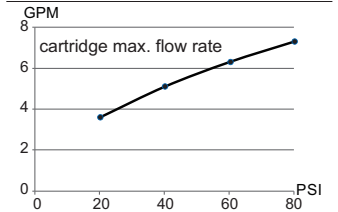

Submittal Information:

Name: _____
Location: _____

Contractor: _____
Contact #: _____

CARACTÉRISTIQUES



Caractéristiques et avantages

- Inverseur sur la soupape
- Nécessite la plomberie brute Treysta® de Gerber de la série G00GS55 avec inverseur, vendue séparément
- Cartouche d'équilibrage de pression à disque en céramique Treysta® comprise
- Bras de douche en métal de 12 po D481376 (D502157LSTC seulement)
- Bec de baignoire de 6 po DA666573 (D502157LSTC seulement)
- Ensemble pour murs profonds au fini assorti, vendu séparément (D113001)
- Ensemble pour murs peu profonds au fini assorti, vendu séparément (GA663B11)

Couleurs/finis offerts

Les carrés de couleur ne sont fournis qu'à titre de référence seulement.

Couleur Code Description

<input type="checkbox"/>	<input type="checkbox"/>	Chrome
<input type="checkbox"/>	<input type="checkbox"/>	BN Nickel Brossé
<input type="checkbox"/>	<input type="checkbox"/>	BS Noir Satiné

Normes et certifications

ASME A112.18.1/CSA B125.1
Conformité aux normes de l'ADA pour le contrôle des poignées à levier

Débit

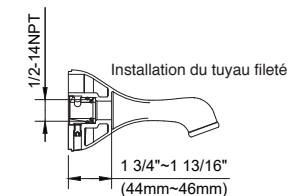
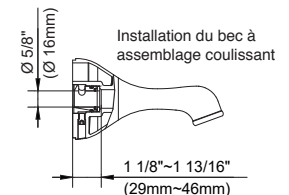
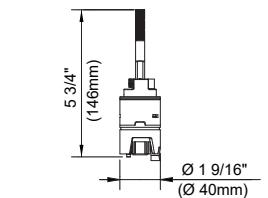
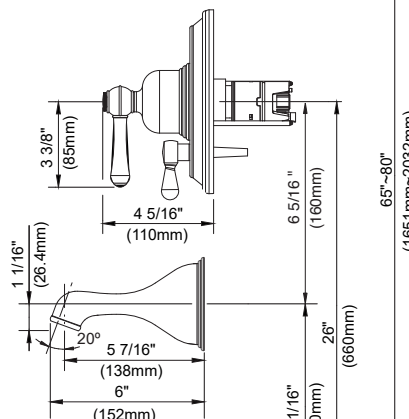
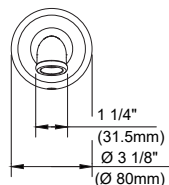
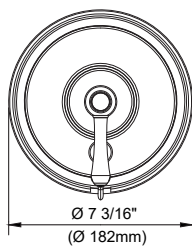
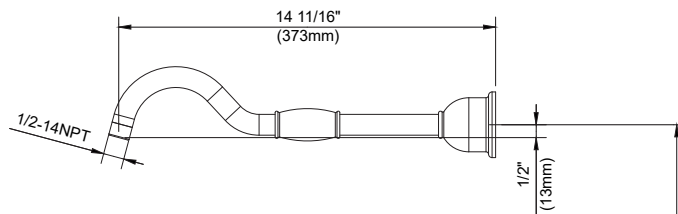
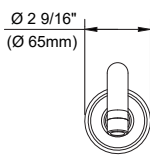
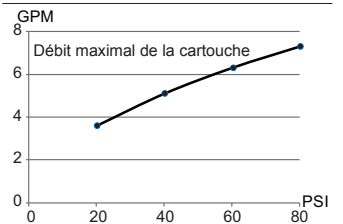

Renseignements pour la soumission :

Nom : _____
Emplacement : _____

Entrepreneur : _____
Numéro de téléphone : _____

ESPECIFICACIONES



Características/Beneficios

- Cambiador de flujo en la válvula
- Requiere empalme Treysta® de Gerber, serie G00GS55 con cambiador de flujo en la válvula, se vende por separado
- Incluye cartucho de balanceo de presión tipo disco de cerámica Treysta®
- Brazo de ducha de metal de 12", D481376 (solo D502157LSTC)
- Caño de bañera de 6" DA666573 (solo D502157LSTC)
- Kit para paredes profundas con el mismo tipo de acabado, D113001, se vende por separado
- Kit para paredes de poca profundidad con el mismo tipo de acabado, GA663B11, se vende por separado

Colores/Acabados disponibles

Los cuadros de color son solo de referencia.

Color Código Descripción

	Cromo
	BN Níquel Cepillado
	BS Negro Satinado

Estándares y certificación

ASME A112.18.1/CSA B125.1
Cumple con la ley ADA sobre el control de la manija de palanca

Caudal

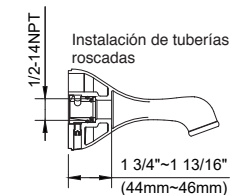
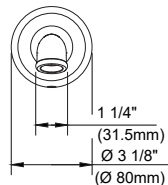
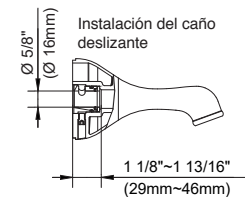
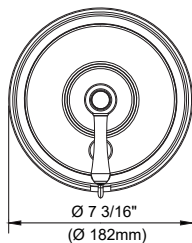
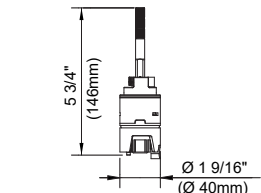
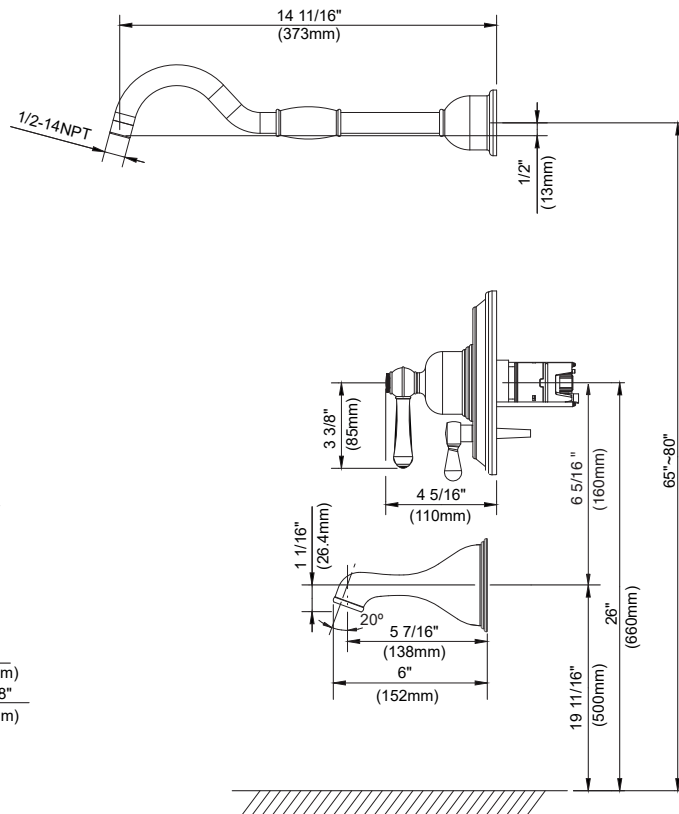
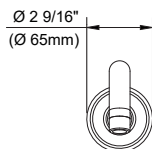
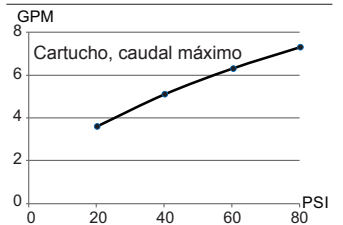

Información a presentar:

Nombre: _____
Ubicación: _____

Contratista: _____
N.º de contacto: _____