



Service Kit Part Number 10041217
ConMet FF-Front Flat Rotor 10037760
Rotor Minimum Thickness 1.46" (37mm)



ConMet 10037760 Flat Rotor

DISC BRAKE ROTOR REPLACEMENT

NOTE

Install the brake rotor using only the hardware provided in the kit.

NOTE

If present, retain stainless steel insulator (see image below).

NOTE

*If Loctite® 272 is not available, use Loctite® 262.

1. If the rotor mounting studs were removed from the hub during disassembly, apply Loctite® 272* to the coarse end of the double-ended stud and to the rotor mounting threads in the hub. Install the studs.
2. Clean all mating surfaces.
3. Place the stainless steel insulator and the rotor on the hub.
4. Install and torque the rotor mounting nuts in a star pattern to 200 ft-lbs.
5. Place the ABS tone ring on the rotor.

1. Hub Assembly (not included)
2. Stainless Steel Insulator (not included)
3. 10037760 Flat Rotor
4. 5/8"-18 UNF Flanged Hex Head Nut (10 ea.)
5. ABS Tone Ring

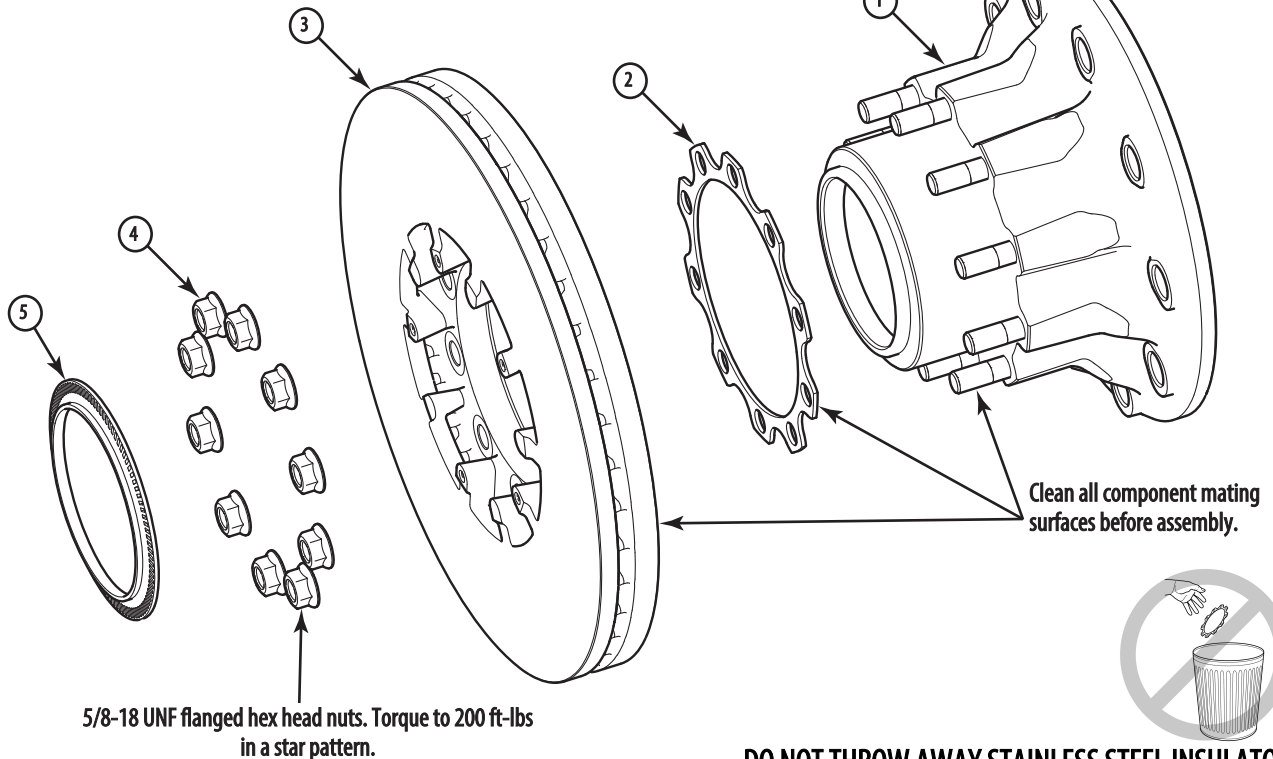

DO NOT THROW AWAY STAINLESS STEEL INSULATOR