

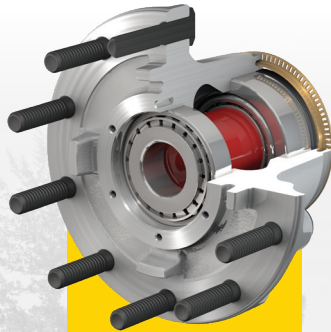

Conventional  
Hub Assemblies

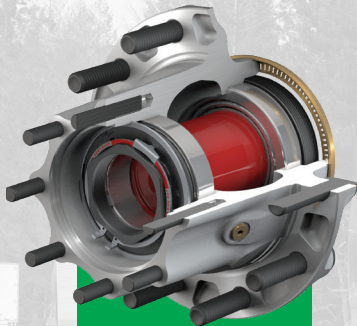

PreSet®  
Hub Assemblies



PreSet Plus®  
Hub Assemblies

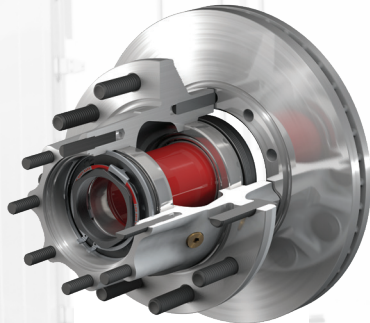

Hub & Rotor  
Assemblies

# SERVICE MANUAL

For Steer, Drive, and Trailer Hub Assemblies

# About this Manual

## Before You Begin

- Read this manual carefully, providing extra attention to its explanations and instructions.
- To ensure safe, continuous, trouble-free operation, understand your wheel hub system, and keep all components in proper operating condition.
- Pay particular attention to all NOTES, CAUTIONS, WARNINGS, and DANGERS to avoid the risk of personal injury or property damage, and realize these statements are not exhaustive. ConMet® cannot possibly know or evaluate all conceivable methods in which service may be performed or the possibly hazardous consequences of each method. Accordingly, those who use a procedure not recommended by ConMet must first satisfy themselves that neither their safety nor the safety of the product will be jeopardized by the service method selected.
- Use only ConMet approved replacement parts. Do not attempt to use damaged parts.
- Follow your company's maintenance and service, installation, and diagnostics guidelines.
- Use special tools when required to help avoid serious personal injury and damage to components

## Color Coding

Throughout this manual we will use the following colors to help identify specific areas that reference Conventional, PreSet®, and PreSet Plus® ConMet hubs.

Conventional 

PreSet 

PreSet Plus 

If a color is not specified, then you can conclude the information is mutual for all hub assemblies.

## Hazard Alert Messages

### **DANGER**

A Danger alert indicates a hazardous situation which if not avoided, will result in death or serious injury.

### **WARNING**

A Warning alert indicates a hazardous situation which if not avoided, could result in death or serious injury.

### **CAUTION**

A Caution alert indicates a hazardous situation which if not avoided, could result in minor or moderate injury.

### **NOTE**

A note includes additional information that may assist the technician in service procedures.

## Additional Maintenance and Service Information

### *On the Web*

Visit [conmet.com](http://conmet.com) to access ConMet's product, sales, service and maintenance literature.

### *ConMet Customer Service*

Call ConMet's Customer Service at 1-800-547-9473.

## ConMet Decals

The following decals are available upon request:

Decal Name	PreSet Part Number	PreSet Plus Part Number
Disc Wheel Installation Procedures	103282	103282
Hubs Lubricated with Oil	106873	10038167
Hubs Lubricated with Semi-Fluid Grease	107383	10038168

# Table of Contents

<b>1. INTRODUCTION</b>	<b>1</b>
Conventional Hubs	1
PreSet Hub Assemblies	1
PreSet Plus Hub Assemblies	1
<b>2. INSPECTION</b>	<b>2</b>
HAZARD ALERT MESSAGES	2
WHEEL END INSPECTION GENERAL GUIDELINES	2
Driver Pre-Trip Visual Inspection	2
In Route Inspections	2
Service Interval	3
Lubrication Analysis	3
<b>3. IDENTIFICATION</b>	<b>4</b>
WHEEL MOUNTING SYSTEMS	4
Hub Pilot Wheel Mounting	4
Ball Seat Wheel Mounting System	4
IDENTIFYING CONMET HUB ASSEMBLIES	4
Vehicle Identification Number (VIN)	4
Casting Number	4
Machining Number	4
Final Hub Assembly Number	5
Julian Date	5
Conventional Wheel Hubs	5
PreSet Wheel Hubs	5
PreSet Plus Wheel Hubs	5
<b>4. CONVENTIONAL WHEEL HUBS</b>	<b>6</b>
HUB REMOVAL AND DISASSEMBLY	6
COMPONENT INSPECTION AND REPLACEMENT HAZARD ALERT MESSAGES	7
CLEAN AND DRY COMPONENTS	7
Worn or Damaged Components	7
Hub and Component Cleaning	7
INSPECTING BEARING CUPS AND CONES	8
REMOVING CUPS IN ALUMINUM HUBS	8
REMOVING CUPS IN IRON HUBS	8
INSTALLING A NEW CUP IN ALUMINUM HUBS	8
INSTALLING A NEW CUP IN IRON HUBS	8
WHEEL STUDS	9
STUD REMOVAL	9
STUD REPLACEMENT	9
HUB, DRUM AND WHEEL INSPECTION	9
ABS TONE RING INSPECTION (AS APPLICABLE)	9
REMOVAL AND INSTALLATION OF MACHINED ABS TONE RING	10
REMOVAL AND INSTALLATION OF STAMPED STEEL ABS TONE RING	10
REMOVAL AND INSTALLATION OF BOLT ON ABS TONE RINGS	10
REASSEMBLY	11
CONVENTIONAL WHEEL HUBS ASSEMBLY	11
REINSTALLATION	12
INSTALLING CONMET CONVENTIONAL WHEEL HUBS	12
Spindle Preparation	12
Conventional Hub Installation	12
Manual Bearing Adjustment Procedure (reference TMC RP618)	13
SERVICE PARTS	14
<b>5. PRESET WHEEL HUBS</b>	<b>17</b>
HUB REMOVAL AND DISASSEMBLY	17
COMPONENT INSPECTION AND REPLACEMENT HAZARD ALERT MESSAGES	18
CLEAN AND DRY COMPONENTS	19
Worn or Damaged Components	19
Hub and Component Cleaning	19
INSPECTING BEARING CUPS AND CONES AND BEARING SPACER	19
REMOVING CUPS IN ALUMINUM HUBS	19
REMOVING CUPS IN IRON HUBS	20
INSTALLING A NEW CUP IN ALUMINUM HUBS	20
INSTALLING A NEW CUP IN IRON HUBS	20
WHEEL STUDS	20
STUD REMOVAL	20
STUD REPLACEMENT	20
HUB, DRUM AND WHEEL INSPECTION	21
ABS TONE RING INSPECTION (AS APPLICABLE)	21
REMOVAL AND INSTALLATION OF ABS TONE RING	21
REMOVAL AND INSTALLATION OF STAMPED STEEL ABS TONE RING	21

# Table of Contents

REMOVAL AND INSTALLATION OF BOLT ON ABS TONE RINGS (FOR DISC BRAKES).....	22
REASSEMBLY.....	23
PRESET WHEEL HUBS.....	23
REINSTALLATION.....	24
INSTALLING THE PRESET WHEEL HUB ASSEMBLY.....	24
Spindle Preparation.....	24
Mounting the Hub.....	24
Spindle Nut Torque.....	24
SERVICE PARTS.....	25
<b>6. PRESET PLUS WHEEL HUBS.....</b>	<b>28</b>
HUB REMOVAL AND DISASSEMBLY.....	28
COMPONENT INSPECTION AND REPLACEMENT HAZARD ALERT MESSAGES.....	30
CLEAN AND DRY COMPONENTS.....	30
Worn or Damaged Components.....	30
Hub and Component Cleaning.....	30
INSPECTING BEARING CUPS AND CONES AND BEARING SPACER.....	30
REMOVING CUPS IN ALUMINUM HUBS.....	31
REMOVING CUPS IN IRON HUBS.....	31
INSTALLING A NEW CUP IN ALUMINUM HUBS.....	31
INSTALLING A NEW CUP IN IRON HUBS.....	31
WHEEL STUDS.....	31
STUD REMOVAL.....	32
STUD REPLACEMENT.....	32
HUB, DRUM AND WHEEL INSPECTION.....	32
ABS TONE RING INSPECTION (AS APPLICABLE).....	32
REMOVAL AND INSTALLATION OF ABS TONE RING.....	32
REMOVAL AND INSTALLATION OF STAMPED STEEL ABS TONE RING.....	33
REMOVAL AND INSTALLATION OF BOLT ON ABS TONE RINGS (FOR DISC BRAKES).....	33
REASSEMBLY.....	34
PRESET PLUS WHEEL HUBS.....	35
Spindle Nut and Spiral Snap Ring Reassembly.....	35
REINSTALLATION.....	36
INSTALLING THE PRESET PLUS WHEEL HUB ASSEMBLY.....	36
SERVICE PARTS.....	37
<b>7. LUBRICATION.....</b>	<b>40</b>
DRIVE HUB LUBRICATION.....	40
STEER AND TRAILER HUBS WITH OIL LUBRICANT.....	40
TRAILER HUBS WITH SEMI-FLUID GREASE LUBRICANT.....	40
<b>8. BRAKE AND WHEEL INSTALLATION.....</b>	<b>41</b>
CALIPER INSTALLATION.....	41
WHEEL INSTALLATION.....	41
HUB PILOT WHEEL MOUNTING SYSTEM.....	41
BALL SEAT WHEEL MOUNTING SYSTEM.....	42
<b>9. WHEEL HUB AND ROTOR.....</b>	<b>44</b>
WHEEL HUBS WITH CONMET DISC BRAKE ROTORS.....	44
Part Number Identification.....	44
Rotor Identification.....	44
<b>10. HUB AND ROTOR INSPECTION.....</b>	<b>45</b>
HAZARD ALERT MESSAGES.....	45
DISC BRAKE ROTOR INSPECTION.....	45
Heat Checks.....	45
Cracks.....	45
Deep Grooves or Scoring.....	46
Blue Marks or Bands.....	46
Polished Rotors.....	46
Martensite Spotted Rotors.....	46
Grease-Stained Rotors.....	47
Lining Transfer.....	47
Clogged or Restricted Vent Holes.....	47
Rotor Runout.....	47
Rotor Thickness.....	48
Rotor Resurfacing.....	48
<b>11. HUB AND ROTOR REMOVAL AND DISC REPLACEMENT.....</b>	<b>49</b>
HAZARD ALERT MESSAGES.....	49
HUB AND ROTOR REMOVAL.....	49
DISC BRAKE ROTOR REPLACEMENT.....	49
<b>WHEEL HUB AND ROTOR – SERVICE PARTS LIST.....</b>	<b>50</b>
<b>WHEEL TORQUE SPECIFICATIONS.....</b>	<b>51</b>

# 1. Introduction

ConMet offers three types of wheel hubs:

- Conventional hubs with manually-adjusted bearings
- PreSet hub assemblies with pre-adjusted bearings
- PreSet Plus hub assemblies with pre-adjusted bearings and an integrated spindle nut

## Conventional Hubs

ConMet conventional hubs feature precision-machined aluminum or iron castings and are available in steer, drive and trailer configurations. Hubs are supplied with bearing cups and studs installed. Bearing cones and wheel seals are supplied by the customer. Bearings must be adjusted manually. See TMC RP618 for specifics of adjustment procedures.

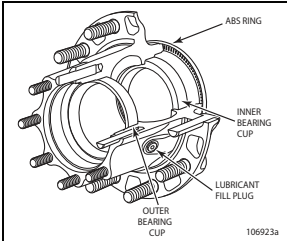

Conventional Hub and Components  
FIGURE 1

## PreSet® Hub Assemblies

ConMet PreSet hub assemblies include precision-machined hubs, premium seals, specially toleranced roller bearings and unique precision-machined bearing spacers. This combination eliminates the need to manually adjust wheel end play. These components are delivered as a complete assembly, reducing the potential for premature failures due to incorrect end play settings and/or improper installation practices.

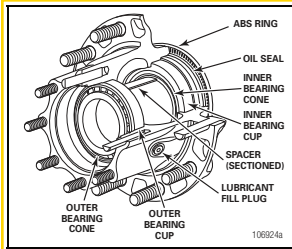

PreSet Hub and Components  
FIGURE 2

## PreSet Plus® Hub Assemblies

ConMet PreSet Plus hub assemblies feature the same PreSet technology and include the same precision-machined hubs, premium seals and specially toleranced roller bearings. However, PreSet Plus hubs incorporate the following:

- An integrated spindle nut that eases installation and protects components during wheel end service
- An optimized spacer
- Standard magnetic fill plug

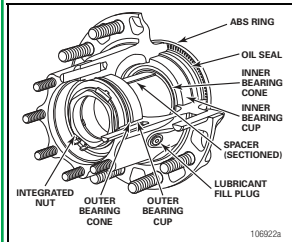

PreSet Plus Hub and Components  
FIGURE 3

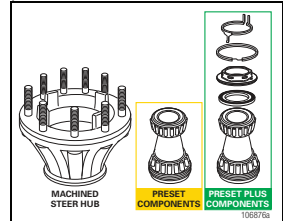

Steer Hub and Components  
FIGURE 4

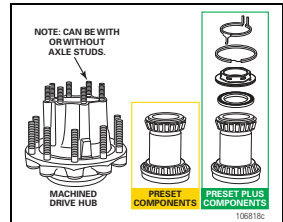

Drive Hub and Components  
FIGURE 5

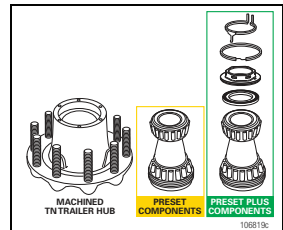

TN Trailer Hub and Components  
FIGURE 6

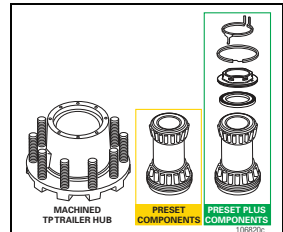

TP Trailer Hub and Components  
FIGURE 7

## 2. Inspection

### HAZARD ALERT MESSAGES

Read and observe all hazard alert messages in this publication. They provide information that can help prevent serious personal injury, damage to components, or both.

#### WARNING

Do not work under a vehicle supported only by jacks. Jacks can slip and fall over. Serious personal injury and damage to components can result.

Park the vehicle on a level surface. Block the wheels to prevent the vehicle from moving. Support the vehicle with safety stands.

To prevent serious eye injury, always wear safe eye protection when you perform vehicle maintenance or service.

### WHEEL END INSPECTION GENERAL GUIDELINES

#### NOTE

Operating temperature can be checked as the vehicle enters the service area following a normal run. If the hub is running in excess of 150°F above the ambient temperature or exceeds 220°F in normal operating conditions, service is required.

Wheel end service and maintenance requirements will vary based on vehicle operating conditions, vehicle specifications, lubrication type, and vehicle performance history. Consolidated Metco recommends the maintenance schedule below, in conjunction with TMC RP631A, to be adjusted as needed for varying conditions.

#### CAUTION

If any item is found to be out of specification during any of the inspection steps listed below, place the vehicle out of service until the item can be repaired or replaced.

### Driver Pre-Trip Visual Inspection

Visually inspect the vehicle prior to operation. Include the following items:

1. Check for loose, damaged, or missing fasteners on the wheel and hub cap or axle. Rust or dark streaks coming from the wheel bolts may be a sign of improper wheel bolt torque.
2. Check for loose, damaged, or missing hubcaps.
3. Check for lubricant leaks at:
  - Hubcap
  - Drive axle flange gasket
  - Oil fill plug
  - Oil seal leakage – indicated by lubricant on the hub, brake components or inside of the wheel
4. Check lubricant condition via hub cap window on steer and trailer hubs. Lubricant that is darkened, milky, shows water in it, or has large metallic particles in it is indicative of contamination or a part failure and must be replaced. Contaminated lubricant may be an indication of a leaking seal that should be replaced.
5. Check for insufficient lubricant level via hub cap window on steer and trailer hubs. Refill lubricant to the indicated fill level if required.

If any of the above conditions are found, place the vehicle out of service until the item can be repaired.

### In Route Inspections

1. After making an in route stop, walk around the vehicle and inspect the hubs for any leaks (per item 3 under Driver Pre-Trip) and significant differences in temperature or excessive temperature. If excessive temperature is found, inspect and repair the wheel end as necessary. High temperatures and high loads may cause early bearing failure. Lubricant viscosity should be chosen based on expected operating temperatures.

### Preventative Maintenance Schedule

During any routine preventative maintenance on the vehicle or axle (see your OEM guidelines and associated federal regulations), inspect the following items:

1. Check for loose, damaged, or missing fasteners on the wheel and hub cap. Rust or dark streaks coming from the wheel bolts may be a sign of improper wheel bolt torque.
2. Check for loose, damaged, or missing hubcaps.
3. Check for lubricant leaks at:
  - Hubcap
  - Drive axle flange gasket
  - Oil fill plug
  - Oil seal – indicated by lubricant on the hub, brake components or inside of the wheel
4. Check for insufficient lubricant level via hub cap window on steer and trailer hubs. Refill lubricant to the indicated fill level if required.

## 2. Inspection (continued)

5. Check the lubricant condition. Lubricant that is darkened, milky, shows water in it or has large metallic particles in it is indicative of contamination or a part failure and must be replaced. Contaminated lubricant may be an indication of a leaking seal that should be replaced.

- On oil lubricated hubs equipped with a fill plug in the hubcap or barrel of the hub, place a magnet (or inspect the magnetic fill plug) in the lubricant and check for signs of large metallic particles picked up by the magnet. On drive axles, it is normal to find a small amount of very fine metallic particles from the carrier housing on the magnetic fill plug. These particles should be removed from the magnet anytime the plug is removed for inspection. If larger particles or chunks of metal are found, the hub should be removed from the spindle and the bearings and other components should be inspected for signs of damage or excessive wear.

- In vehicles without a fill plug in drive hubs inspect the lubricant volume and condition from the fill plug in the axle carrier housing.
- For vehicles lubricated with semi-fluid grease, inspect annually or every 100,000 miles. First, remove the hubcap and inspect the lubricant condition and volume. Verify the lubricant covers the ends of the bearing rollers. If the lubricant condition is good, add lubricant through the fill plug in the barrel of the hub to cover the ends of the bearing rollers. If the lubricant has a dry and caked appearance, remove the wheel end from

the vehicle and clean and inspect all components. Replace damaged or worn components as necessary. Refill hub with semi-fluid grease amount per chart on page 42.

6. If regular scheduled maintenance requires wheels/ axle to be lifted, perform steps 7 and 8.
7. Lift and support the axle (see figure 8). Rotate the wheel. Check that the wheel rotates freely and smoothly. Listen and feel for any signs of rough bearing operation or vibration.

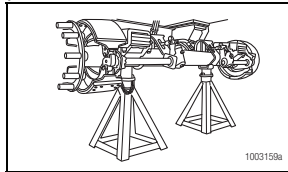

FIGURE 8

8. Place your hand on the top of the tire and use a pry bar to lift the bottom of the tire to check for loose bearings or "chucking" (see figure 9). If excess movement or "chucking" is found, wheel end service is required.

### NOTE

Before you check for chucking, be sure to grease the king pins.

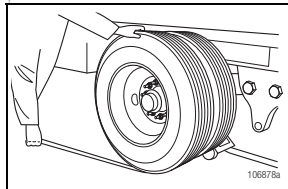

FIGURE 9

If any of the above conditions are found, place the vehicle out of service until the item can be repaired.

### Service Interval

Inspection results at driver pre-trip, in-route and preventative maintenance will indicate whether further service is required. When inspections indicate that service is necessary, follow the recommended service, inspection, reassembly and reinstallation instructions found in the following sections of this manual.

### Lubrication Analysis

Beyond the recommended visual inspection and inspection with a magnet, develop a lubrication testing and replacement program. This program will depend on vehicle application, and lubrication type. A lubricant supplier should be consulted for additional lubricant inspection and testing recommendations.

# 3. Identification

## WHEEL MOUNTING SYSTEMS

ConMet wheel hubs are available in both hub pilot and ball seat nut configurations.

### Hub Pilot Wheel Mounting

The hub pilot wheel mounting system makes use of a single two-piece flange nut on each wheel stud for both single and dual wheel applications (see figure 10). The hub pilot wheel mounting system is also known as the Uni-Mount-10™ (10 stud), WHD-10™ (10 stud), WHD-8™ (8 stud), and ISO system.

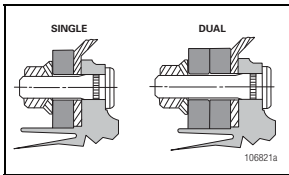

Hub Pilot Mounting System  
FIGURE 10

### Ball Seat Wheel Mounting System

The ball seat wheel mounting system makes use of the spherical contact area between the nut and wheel to both locate the wheel and hold the wheel tight against the brake drum (see figure 11).

The ball seat wheel mounting system is also known as the stud piloted, ball seat cap nut (BCN) and double cap nut (DCN) system.

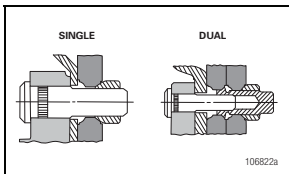

Ball Seat Mounting System  
FIGURE 11

## IDENTIFYING CONMET HUB ASSEMBLIES

Identifying your hub assembly is important for many reasons. It will enable you to properly service the hub assembly and purchase the appropriate replacement parts if needed. Plus, if a warranty issue arises, you'll then be able to provide details on all aspects of the ConMet hub. This section is devoted to finding and understanding the different identification numbers associated with ConMet hubs.

### Vehicle Identification Number (VIN)

The quickest and easiest method of identifying your hub assembly is to note the vehicle identification number (VIN) and call the truck dealership. The dealership can then tell you what hubs were installed on your vehicle. If this is not possible, there is a variety of identification numbers located on a ConMet hub assembly.

### Casting Number

This number is physically cast into the hub and appears in large characters usually on the back side of the mounting flange near the stud head (see figure 12).

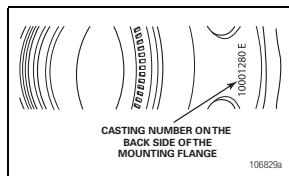

Casting Number on the Back Side of the Mounting Flange  
FIGURE 12

### Machining Number

This number is stamped on one of the following:

- Mounting flange face (see figure 13)
- Diameter of the mounting flange (see figure 14)
- Back side of the mounting flange (see figure 15)
- Barrel of the hub (see figure 16)

The machining number represents the way the hub is machined (e.g., hub pilot vs. ball seat, 8.78" vs. 8.53" vs. 9" brake drum pilot diameter).

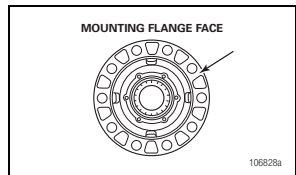

Mounting Flange Face  
FIGURE 13

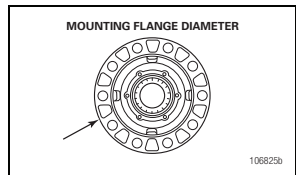

Mounting Flange Diameter  
FIGURE 14

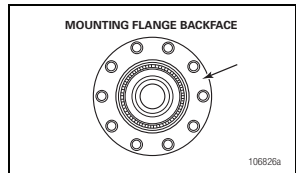

Mounting Flange Backface  
FIGURE 15



### 3. Identification (continued)

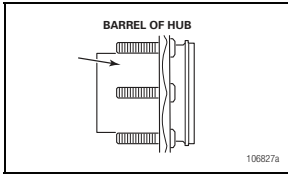

Barrel of Hub  
FIGURE 16

#### **Final Hub Assembly Number**

This number is stamped on one of the following:

- Mounting flange face (see figure 13)
- Diameter of the mounting flange (see figure 14)
- Back side of the mounting flange (see figure 15)

The final hub assembly number identifies the hub assembly, hub machining, studs, bearings, spacer, seal and ABS ring.

#### **Julian Date**

The casting, machining, and the final assembly have Julian dates stamped into the hub assembly in the same location as the assembly numbers (see figures 13, 14, 15 and 16). A Julian date appears as the day of the year plus the last two digits of the calendar year (e.g., July 4 2008 would appear as 18508). This number provides the date when the hub was machined and assembled at the factory and may be used for warranty purposes.

#### **Conventional Hubs**

For instructions on installing ConMet's Conventional hub (see figure 17), refer to the Conventional reinstallation instructions in section 4.

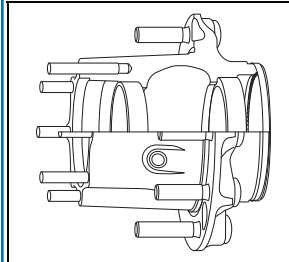

PreSet Plus Hub Assembly  
FIGURE 19

#### **PreSet Plus® Hub Assemblies**

For instructions on installing ConMet's PreSet Plus hub assemblies (see figure 19), refer to the PreSet hub assembly reinstallation instructions in section 6.

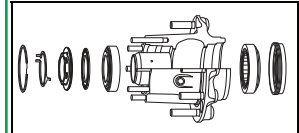

PreSet Plus Hub Assembly  
FIGURE 19

#### **PreSet® Hub Assemblies**

For instructions on installing ConMet's PreSet hub assemblies (see figure 18), refer to the PreSet hub reinstallation instructions in section 5.

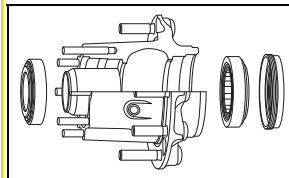

PreSet Hub Assembly  
FIGURE 18

# 4. Conventional Wheel Hubs – Recommended Service

## Conventional Hubs

ConMet conventional hubs feature precision-machined aluminum or iron castings and are available in steer, drive and trailer configurations. Hubs are supplied with bearing cups and studs installed. Bearing cones and seal are supplied by the customer. Bearings must be adjusted manually. See TMC RP618 specifics of adjustment procedures.

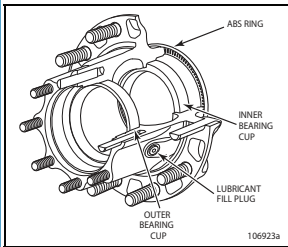

Conventional Hub and Components  
FIGURE 20

When inspections indicate that service is necessary on a conventional hub, follow the recommended service, inspection, reassembly and reinstallation instructions found in the following section.

## HUB REMOVAL AND DISASSEMBLY

### ⚠ WARNING

Vehicles on jacks can fall, causing serious personal injury or property damage. Never work under a vehicle supported by a jack without supporting the vehicle with stands and blocking the wheels. Wear safe eye protection.

1. Park the vehicle on a level surface. Block the wheels to prevent the vehicle from moving.
2. Raise the axle until the tires are off the floor.

3. Place safety stands under the trailer frame or under each axle spring seat (see figure 21).

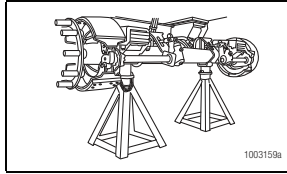

FIGURE 21

4. Remove the tire and wheel assembly using procedures specified by the wheel manufacturer (see figure 22).

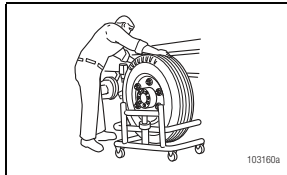

FIGURE 22

### ⚠ WARNING

Sudden release of compressed air can cause serious personal injury and damage to components.

Before you service a spring chamber, carefully follow the manufacturer's instructions to compress and lock the spring to completely release the brake. Verify that no air pressure remains in the service chamber before you proceed.

5. If the axle is equipped with spring brake chambers, carefully compress and lock the springs so that they cannot actuate (see figure 23).

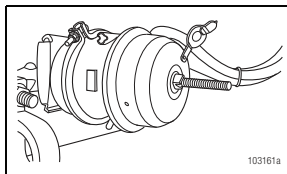
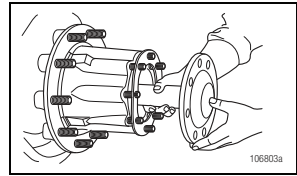

FIGURE 23

6. For drum brakes, remove the brake drum. Support the drum during the removal process to prevent damage to the components. For disc brakes, remove caliper per manufacturers' recommended procedure.

### NOTE

If the hub to be disassembled is a drive hub, remove the drive axle shaft, and capture the oil (see figure 24).



Removing the Drive Axle Shaft  
FIGURE 24

7. Place a container under the hubcap, or drive axle shaft for a drive hub, to receive the draining oil, then remove the hubcap or drive axle shaft. Do not reuse the oil. Correctly dispose of the lubricant.
8. Examine the spindle nut to determine the type of locking system. Disengage the locking device.

### ⚠ WARNING

Do not loosen the axle spindle nuts by either striking them directly with a hammer, or striking a drift or chisel placed against them. Damage to the parts will occur causing possible loss of axle wheel-end components and serious personal injury.

9. Remove the spindle nut system.

# 4. Conventional Wheel Hubs – Recommended Service

10. Slide the hub off the spindle. Remove and save the outer bearing cone. Be careful when you remove the hub that you do not damage the outer bearing by dropping it on the floor.

- If the hub is difficult to remove because the seal or bearings are stuck on the spindle, use a mechanical puller to remove the hub (see figure 25).
- If part of the seal remains on the spindle, carefully remove the part of the seal that remains on the spindle.

### NOTE

This can be done by striking the remaining portion of the seal with the round end of a ball-peen hammer. Use caution not to damage the seal journal on the spindle.

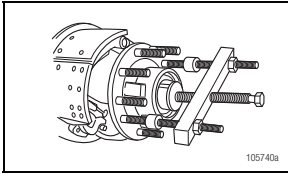
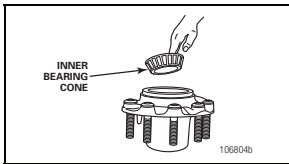

FIGURE 25

11. Place the hub on its outboard end and remove the seal. Retain the seal if it needs to be returned for warranty consideration.
12. Remove the inner bearing cone (see figure 26).



Hub Disassembly  
FIGURE 26

## COMPONENT INSPECTION AND REPLACEMENT HAZARD ALERT MESSAGES

Read and observe all hazard alert messages in this publication. They provide information that can help prevent serious personal injury, damage to components, or both.

### WARNING

To prevent serious eye injury, always wear safe eye protection when you perform vehicle maintenance or service.

Observe all warnings and cautions provided by the press manufacturer to avoid damage to components and serious personal injury. Do not hit steel parts with a steel hammer. Pieces of a part can break off. Serious personal injury and damage to components can result. Use a brass or synthetic mallet for assembly and disassembly procedures.

Solvent cleaners can be flammable, poisonous and cause burns. Examples of solvent cleaners are carbon tetrachloride, and emulsion-type and petroleum-base cleaners. Read the manufacturer's instructions before using a solvent cleaner, then carefully follow the instructions. Also follow the procedures below.

- Wear safe eye protection.
- Wear clothing that protects your skin.
- Work in a well-ventilated area.
- Do not use gasoline or solvents that contain gasoline. Gasoline can explode.
- You must use hot solution tanks or alkaline solutions correctly. Read the manufacturer's instructions before using hot solution tanks and alkaline solutions. Then carefully follow the instructions.

### CAUTION

Do not use hot solution tanks or water and alkaline solutions to clean ground or polished parts. Damage to parts can result.

## CLEAN AND DRY COMPONENTS

### Worn or Damaged Components

#### WARNING

Do not repair or recondition wheel-end components. Replace damaged, worn or out-of-specification components. Do not mill or machine any components. Using repaired, reconditioned, damaged or worn components can cause wheel end failure, which can result in serious injury and property damage.

### Hub and Component Cleaning

1. Use a cleaning solvent to clean the hub and all wheel end components.
2. Do NOT clean ground or polished parts in a hot solution tank or with water, steam or alkaline solutions. These solutions will cause corrosion of the parts.
3. Clean and inspect the wheel bearing cups and cones, race, spindle bearing and seal journals on the spindle and hub. Bearings should be cleaned with clean filtered solvent and dried with either compressed air or a lint-free rag.

#### CAUTION

If compressed air is used, do not spin dry the bearings. The rollers may score due to lack of lubricant and rollers could come off which can result in serious injury. Ensure that the air line is moisture free.

4. Clean and inspect the spindle. Be sure to clean the full length of the seal journal on the spindle.
5. Parts must be dried immediately after cleaning. Dry parts with clean paper towels or rags, or compressed air. Do not dry bearings by spinning with compressed air.

## 4. Conventional Wheel Hubs – Recommended Service

- Apply a light oil to cleaned and dried parts that are not damaged and are to be immediately assembled. Use only the type of oil used by the manufacturer. Do NOT apply oil to the brake linings or the brake drums.
- If the parts are to be stored, apply a good corrosion preventative to all surfaces. Do NOT apply the material to the brake linings or the brake drums. Store the parts inside special paper or other material that prevents corrosion.

### INSPECTING BEARING CUPS AND CONES

#### CAUTION

If you choose to reuse existing bearings at this service, they must be inspected in accordance with the bearing manufacturers recommended guidelines.

#### CAUTION

If this inspection indicates that existing bearing component(s) must be replaced, bearing cups and cones must be replaced as a set.

After components have been properly cleaned, visually inspect the cups and cones for any wear or damage. Reference TMC RP644 for proper component inspection procedures.

### REMOVING CUPS IN ALUMINUM HUBS

- If the bearing cup must be removed from an aluminum hub, remove it by welding a large bead around the bearing surface of the steel cup, letting the assembly cool, and removing the bearing cup (see figure 27).

#### NOTE

If a welder is not available, heat the hub in an oven to a temperature not to exceed 300°F and pound out the bearing cups with a hammer and mild steel bar, being careful not to damage the hub.

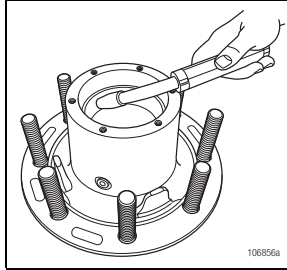

Welding Bead  
FIGURE 27

- Inspect the bearing cup bore for evidence of cup rotation or spun cups.
  - If cup rotation exists, replace the hub.

### REMOVING CUPS IN IRON HUBS

- On an iron hub, remove the bearing cup using a large hammer and a mild steel bar or a hydraulic press. Take precaution to avoid damaging the bearing cup bore and shoulder.
- Inspect the bearing cup bore for evidence of cup rotation or spun cups.
  - If cup rotation exists, replace the hub.

### INSTALLING A NEW CUP IN ALUMINUM HUBS

To install a new cup in an aluminum hub, it is recommended that the hub be heated in boiling water (212°F) or in an oven at a temperature not to exceed 300°F. Cooling the cup in a freezer to 32°F or below will further ease the installation.

#### WARNING

Do not overheat the hub as it may degrade the heat-treated strength of the hub. Do not heat the hub with a torch or open flame.

Remove the aluminum hub from the oven or water and carefully drop in the new bearing cup being certain it is fully seated. If the cup is loose, allow a few seconds for it to heat up and secure itself before moving the hub. Use a 0.001" to 0.002" feeler gauge to ensure the cup is fully seated against the shoulder of the bearing bore.

### INSTALLING A NEW CUP IN IRON HUBS

Iron hubs do not need to be heated for bearing cup installation. Press the bearing cup into the hub, being certain that it is fully seated (see figure 28). Use a 0.001" to 0.002" feeler gauge to ensure the cup is fully seated against the shoulder of the bearing bore.

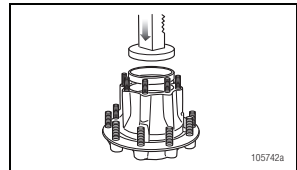

Bearing Cup Pressed into Hub  
FIGURE 28

# 4. Conventional Wheel Hubs – Recommended Service

## WHEEL STUDS

Replace all wheel studs that have damaged or distorted threads, are broken or bent, or are badly corroded. Also, replace both studs adjacent to the damaged stud. If two or more studs have damage, replace all the studs in the hub. Broken studs are usually an indication of excessive or inadequate wheel nut torque.

## STUD REMOVAL

### ⚠ WARNING

Observe all warnings and cautions for press operation provided by the press manufacturer to avoid serious personal injury and damage to components.

1. Place the clean hub in a shop press with the hub supported evenly around and adjacent to the stud being removed.

### ⚠ WARNING

Failure to adequately support the hub can result in physical injury and/or damage to the hub. Some hubs are configured so it is impractical to have supports to prevent the hub from tipping when force is applied to the stud. In this case, support the hub on wood blocks on the floor and use a heavy hammer to drive the studs out with several sharp blows. Be careful to avoid damaging the hub and components, particularly the seal bore and the ABS tone ring.

2. Press the stud out of the hub.

## STUD REPLACEMENT

### ⚠ CAUTION

On the ball seat wheel mounting system, always use left-handed threaded studs, which are gold in color and have an "L" stamped on the end, in the hub on the driver's side of the equipment, and use right-handed threaded studs, which are silver in color and have an "R" stamped on the end, in the hub on the passenger's side of the equipment. The ConMet part number is located on the head of the stud. The same part number must be used for replacement unless changing the drum or wheel type.

1. To install a new stud, support the hub evenly around and adjacent to the stud being installed.
2. Press the new stud all the way into the hub. Be sure the stud is fully seated and that the stud head is not embedded into the hub.

### ⚠ WARNING

Excessive force can cause the stud head to be embedded into the hub, which can create a crack in the hub, resulting in serious injury and property damage. If a stud head is embedded in a hub, replace the hub.

## HUB, DRUM AND WHEEL INSPECTION

1. Inspect the drum pilots, wheel pilots, and mounting face on the hub for damage. A damaged drum pilot is usually caused by improper drum mounting. A damaged wheel pilot could be the result of inadequate wheel nut torque, allowing the wheels to slip in service. Also, inspect other surfaces of the hub for signs of cracks or damage.
2. Inspect the wheels and brake drum for damage.

### ⚠ WARNING

Do not repair or recondition wheel-end components. Replace damaged, worn or out-of-specification components. Do not mill or machine any components. Using repaired, reconditioned, damaged or worn components can cause wheel end failure, which can result in serious injury and property damage.

## ABS TONE RING INSPECTION (AS APPLICABLE)

The Anti-Lock Braking System (ABS) signals acts like any signal generator where the magnet passes a coil and generates a current. On hubs, the toothed ring passes a sensor and generates a signal that is sent to the ABS computer. There are four types of ABS rings used on ConMet hubs — machined, stamped steel, bolt on and snap-in (see figure 29).

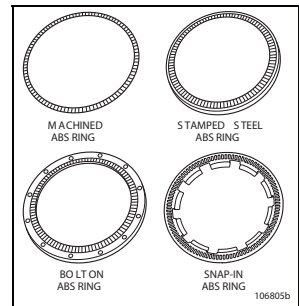

FIGURE 29

If the tone ring is damaged (for example, if it is dropped, bent, chipped or dinged), it must be replaced. For a list of replacement ABS rings, refer to the Service Parts List in the back of this section.

## 4. Conventional Wheel Hubs – Recommended Service

### REMOVAL AND INSTALLATION OF MACHINED ABS TONE RING

For a machined ring, remove using a chisel, making sure not to damage the hub (see figure 30). Reinstall by pressing the ring on until it bottoms out on hub.

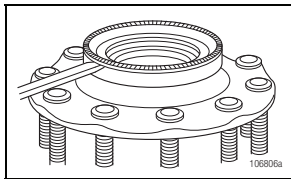

Machined ABS Ring  
FIGURE 30

### REMOVAL AND INSTALLATION OF STAMPED STEEL ABS TONE RING

1. The steer axle tone ring can be removed by gripping the ring with a pair of locking pliers and tapping the pliers upward with a rubber mallet. Work around the ring to keep the ring from cocking (see figure 31). Drive axle and trailer tone rings can be removed by gripping the ring with a pair of locking pliers and prying against the head of a wheel stud to lift the ring off the hub. Work around the ring to prevent cocking (see figure 32).

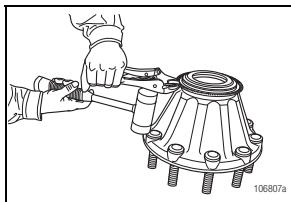

Stamped Steel ABS Ring  
FIGURE 31

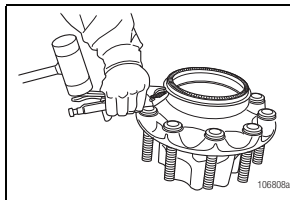

Stamped Steel ABS Ring  
FIGURE 32

2. Thoroughly clean and degrease the ABS ring seat on the hub with a nonflammable solvent.

#### CAUTION

Replace the hub if the ABS ring seat is damaged. The ABS ring must be fully seated with a maximum of 0.008" axial runout to ensure the ABS system functions properly.

#### NOTE

For steer hubs, be certain the inside diameter flange is facing up.

3. Place the hub in a press and place the ABS ring on the hub ring seat.
4. Using ConMet ring installation tool (part number 107119), center the tool over the ABS ring. Each type of ring fits a corresponding diameter on the tool (see figure 33).

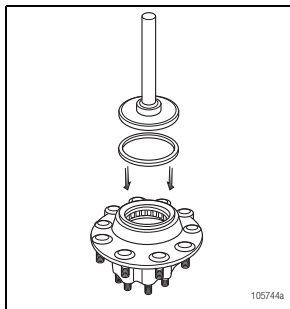

Installing the ABS Tone Ring  
FIGURE 33

5. Press the ring on the hub. If a press is not available, drive the ring on with a hammer or mallet until the ring seats on the hub (see figure 34). A swift initial blow with an 8-lb. hammer may be necessary to start the ring onto the hub.

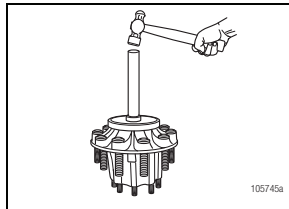

Using a Hammer to Install the Ring  
FIGURE 34

6. Inspect the ring to ensure proper seating. If the ring is not completely seated, continue to drive the ring with the ring installation tool until it is completely seated.

### REMOVAL AND INSTALLATION OF BOLT ON ABS TONE RINGS

1. Remove and discard the fasteners holding the ABS tone ring on the hub.
2. Thoroughly clean and degrease the ABS ring seat on the hub with a non-flammable solvent.
3. Install the new ABS ring using the new fasteners included with the ring. Torque the fasteners to the torque specifications below.

Thread Size	Torque
#8-32	18-22 in-lbs
1/4"-20	125-135 in-lbs

# 4. Conventional Wheel Hubs – Reassembly

## CONVENTIONAL WHEEL HUBS REASSEMBLY

### CAUTION

When using an oil bath system, do not pack the bearing with grease. Grease will prevent the proper circulation of axle lubricant and can cause premature wheel seal and bearing failure.

1. Place the hub, seal end up, on a clean work surface.
2. Lubricate the inner bearing cone with the same lubricant as will be used in the hub and install it into the inner bearing cup (see figure 35).

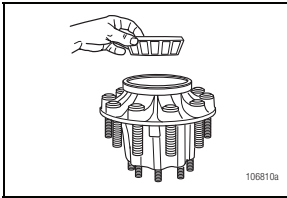

Bearing Cone Assembly  
FIGURE 35

3. Use a clean applicator to lightly lubricate the seal bore of the hub.

### NOTE

Only several drops of oil are needed to lubricate the seal bore and inner diameter. Using excess lubricant could result in a false leak diagnosis when undergoing inspection.

### NOTE

The seal must be replaced every time the hub is removed from the spindle.

Do not apply any gasket sealant to the seal outer or inner diameter.

Always use the seal installation tool specified by the seal manufacturer. Using an improper tool can distort or damage the seal and cause premature seal failure.

4. Position the seal into the hub bore. Use a ConMet seal installation tool or flat plate and a small mallet to install the seal.

### NOTE

ConMet seals require the proper tool for installation. Refer to the tables below for a ConMet seal installation tool or flat plate dimensions. For other seals, refer to the specific manufacturers' instructions.

#### ConMet Installation Tools

Axle Type	Part Number
FF Steer	10084010
FL Steer	10084011
R-Drive	10084012
TN-Trailer	10084013
TP-Trailer	10084013

#### Flat Plate Dimensions

Application	Seal Part Number	Min. Dia.	Max. Dia.
FF Steer	10045885	4.45"	4.65"
FL Steer	10045883	5.2"	5.4"
R-Drive	10045887	5.6"	5.85"
TN-Trailer	10045888	5.6"	5.85"
TP-Trailer	10045889	5.6"	5.85"

5. When installing the ConMet seal, tap the adapter plate of the installation tool or flat plate around the outer edge to position the seal. Drive the wheel seal into place (see figure 36).

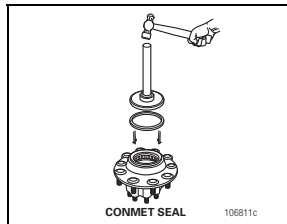

ConMet Seal Installation  
FIGURE 36

6. Check to be certain the seal is uniformly bottomed out in hub bore and that the seal inner diameter and the inner bearing turn freely.

### CAUTION

Failure to lubricate the inner diameter of the seal may result in premature seal failure.

7. Lubricate the inner diameter of the seal with a light film of the same lubricant as will be used in the hub.
8. Turn the hub over, and place it seal end down.
9. Lubricate the outer bearing cone with the same lubricant as will be used in the hub and install it into the hub assembly (see figure 37).

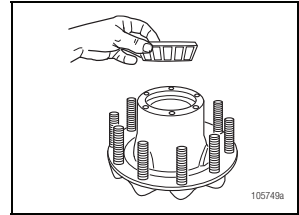

Installing the Bearing Cone  
FIGURE 37

## 4. Conventional Wheel Hubs – Reinstallation

### INSTALLING ConMet CONVENTIONAL WHEEL HUBS

#### Spindle Preparation

1. Clean the spindle to remove any lubricant, corrosion prevention coating, foreign material, or surface rust that may be present. Be sure to clean the full length of the seal journal.
2. Lubricate the bearing journals on the spindle, or the inside diameter of the bearing cones with Grade 2 grease or the lubricant that will be used in the wheel end. Do not coat the seal journal on the spindle.
3. Lubricate the inside diameter of the seal with the same lubricant that will be used in the wheel end.



#### CAUTION

Failure to apply lubricant to the bearing journals will result in fretting corrosion, which may result in difficulty removing the bearing. Never support the hub on the spindle with just the inner bearing and seal. This can damage the seal and cause premature failure, i.e. by cocking the seal in the bore.

#### Conventional Hub Installation

#### NOTE

Existing spindle nuts can be re-used as long as they are in good condition. Do not re-use a spindle nut that is worn or pitted on its face or threads.

#### NOTE

See TMC RP618 for more details regarding installation of wheel hubs with manual adjusted bearing systems.

#### NOTE

The following service procedures apply to steer, drive, and trailer axle assemblies using conventional double nut or single nut systems. For self-locking single nut systems, consult manufacturers' instructions.

1. Lubricate the bearings with clean lubricant of the same type used in the axle sump or hub assembly.
2. Install the wheel hub and bearing onto the axle spindle with a smooth, firm motion. Use care to maintain alignment between the bearing cones, and spindle to avoid seal damage. Torque the inner adjusting nut to 200 ft-lbs while rotating the hub assembly, repeat for a total of three times.
3. Back off the inner adjusting nut one full turn. Rotate the hub.
4. Re-torque the inner adjusting nut to 50 ft-lbs while rotating the wheel hub assembly.
5. Back off the inner adjustment nuts as per the Manual Bearing Adjustment Procedure table (next page).
6. Install the locking washer.

#### NOTE

If dowel pin and washer (or washer tang and nut flat) are not aligned, remove the washer, turn it over, and reinstall. If required, loosen the inner (adjusting) nut just enough for alignment.

#### NOTE

Bendable type washer lock only: Secure nuts by bending one wheel nut washer tang over the inner and outer nut. Bend the tangs over the closest flat perpendicular to the tang.

7. Install and torque the outer jam nut as per chart on next page.
8. Use a dial indicator to verify acceptable endplay of 0.001"-0.005".

#### NOTE

If end play is not within specification, readjustment is required. Be sure to install or activate any locking device.

#### NOTE

This information is intended for reference only. Consolidated Metco inc. does not assume any liability in the event of improper use or mismatch of components. For additional information, see TMC RP618.



## 4. Conventional Wheel Hubs – Reinstallation

### Manual Bearing Adjustment Procedure (reference TMC RP618)

Axle type	Axle Spindle Threads per inch	Spindle Nut Type	Final Spindle Nut Backoff	Jam Nut Torque (ft-lbs)
Steer (front non-drive)	12	Single nut with cotter pin	1/6 turn	Install cotter pin to lock spindle nut into position (from step 6)
	18		1/4 turn	
	12	Double nut system with bendable tang washer or dowel pin and washer	1/3 turn	200-300
	14		1/2 turn	
	18			
Drive	12	Double nut system Dowel pin and washer	1/4 turn	300-400
	16			
	12	Double nut system with bendable tang washer	1/4 turn	200-275
	16			
Trailer	12	Double nut system with bendable tang washer or dowel pin and washer	1/4 turn	200-300
	16			

## 4. Conventional Wheel Hubs – Service Parts

### Axle Designations

Designation	Typical Axle Rating (lbs)	Comments
<b>Steer Axle</b>		
FC Steer	8,000	Medium duty
FF Steer	12,000-14,700	Standard linehaul axle. Comes in two spindle variations 1. Flat locking feature with 12 threads/inch. 2. Keyway locking feature with 18 threads/inch.
FL Steer	20,000	Vocational applications
<b>Drive axle</b>		
L-Drive (190)	19,000	Medium duty
R-Drive	20,000-23,000	Standard linehaul axle
<b>Trailer Axle</b>		
TN Trailer	22,500	Tapered spindle
TP Trailer	25,000	Parallel spindle or "Propar"

**NOTE:** These axle ratings are to be used as a reference only. Refer to the vehicle's door plate for your specific application.

### ConMet Seals

Position	Spindle Type	Aftermarket Part Number
Steer	FF Spindle	10045885
	FL Spindle	10045883
	FC Spindle	10088276
Drive	R Spindle	10045887
	L/190 Spindle	10084180
Trailer	TP Spindle	10045889
	TN Spindle	10045888

### ConMet Seal Installation Tools

Axle Designation	Installation Tool Part Number	Minimum Diameter*	Maximum Diameter*
FF Steer	10084010	4.45"	4.65"
FL Steer	10084011	5.2"	5.4"
R-Drive	10084012	5.6"	5.85"
TN Trailer	10084013		
TP Trailer	10084013		

\*Required flat plate dimensions if you are not using a ConMet installation tool (minimum of 3/8", 9.5 mm thick).

## 4. Conventional Wheel Hubs – Service Parts

### Approved Conventional Aftermarket Bearings

Description	ConMet Number	Bearing Set Number
<b>FC Steer Axle</b>		
Inner Cup & Cone	10037695	Not available in sets
Outer Cup & Cone	10037696	
<b>FF Steer Axle</b>		
Inner Cup & Cone	10041905	Set 413
Outer Cup & Cone	10041906	Set 406
<b>FL Steer Axle</b>		
Inner Cup & Cone	10041925	Set 423
Outer Cup & Cone	10041926	Set 424
<b>L-Drive (190) Axle</b>		
Inner Cup & Cone	10037959	Not available in sets
Outer Cup & Cone	10037960	
<b>R-Drive Axle</b>		
Inner Cup & Cone	10041915	Set 403
Outer Cup & Cone	10041916	Set 401
<b>TN Trailer Axle</b>		
Inner Cup & Cone	10041935	Set 414
Outer Cup & Cone	10041905	Set 413
<b>TP Trailer Axle</b>		
Inner Cup & Cone	10041945	Set 415
Outer Cup & Cone	10041945	Set 415

## 4. Conventional Wheel Hubs – Service Parts

### ABS Rings for ConMet Hubs (for reference only)

Axle	Material	Type of Brake	Hub Casting Number	ABS Ring Part Number
FC Steer	Iron	Drum	10016569	10016586
FF Steer	Aluminum	Disc	10016331	10009780
			10018723	10009780
			10020207	10009780
		Drum	101945	10009780
			103110	10009780
			104112	10009780
	Iron	Disc	10011945	10009780
			10019965	10023558
		Drum	10000776	10009780
			10005604	10009780
FL Steer	Aluminum	Drum	10012265	10019840
	Iron	Disc	10005561	107912
L-Drive (190)	Iron	Disc	10020602	10023559
		Drum	10020627	10023757
R-Drive	Aluminum	Disc	10016328	103705
		Drum	10001280	103705
	Iron	Drum	10001387	103705
			10018310	103705
			10018311	103705
TN Trailer	Aluminum	Drum	102035	105459
TP Trailer	Aluminum	Disc	10016620	10019896
		Drum	10001216	105459
	Iron	Drum	10025633	10023829

**NOTE**

If an ABS ring is not listed for a particular hub, contact ConMet Customer Service at 800-547-9473.

# 5. PreSet Wheel Hubs – Recommended Service

## PreSet® Hub Assemblies

ConMet PreSet hub assemblies include precision-machined hubs, premium seals, specially toleranced roller bearings and unique precision-machined bearing spacers. This combination eliminates the need to manually adjust wheel end play. These components are delivered as a complete assembly, reducing the potential for premature failures due to incorrect end play settings and/or improper installation practices.

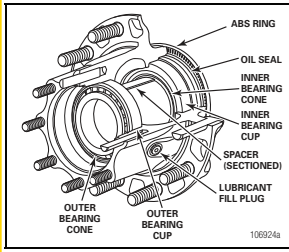

PreSet Hub and Components  
FIGURE 38

When inspections indicate that service is necessary on a PreSet Hub, follow the recommended service, inspection, reassembly and reinstallation instructions found in the following section.

In order to ensure optimum wheel hub performance, ConMet recommends that only approved PreSet service parts be used to replace all critical components of the system. Refer to the back of this section for a listing of approved parts.

## HUB REMOVAL AND DISASSEMBLY

### ⚠ WARNING

Vehicles on jacks can fall, causing serious personal injury or property damage.  
Never work under a vehicle supported by a jack without supporting the vehicle with stands and blocking the wheels. Wear safe eye protection.

1. Park the vehicle on a level surface. Block the wheels to prevent the vehicle from moving.
2. Raise the axle until the tires are off the floor.
3. Place safety stands under the trailer frame or under each axle spring seat (see figure 39).

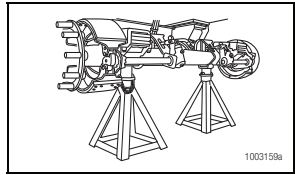

FIGURE 39

4. Remove the tire and wheel assembly using procedures specified by the wheel manufacturer (see figure 40).

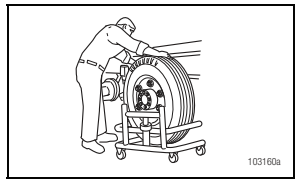

FIGURE 40

### ⚠ WARNING

Sudden release of compressed air can cause serious personal injury and damage to components.  
Before you service a spring chamber, carefully follow the manufacturer's instructions to compress and lock the spring to completely release the brake. Verify that no air pressure remains in the service chamber before you proceed.

5. If the axle is equipped with spring brake chambers, carefully compress and lock the springs so that they cannot actuate (see figure 41).

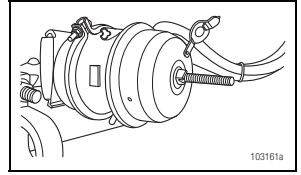
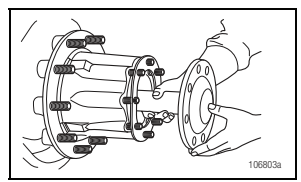

FIGURE 41

6. For drum brakes, remove the brake drum. Support the drum during the removal process to prevent damage to the components. For disc brakes, remove caliper per manufacturers' recommended procedure.

### NOTE

If the hub to be disassembled is a drive hub, remove the drive axle shaft, and capture the oil (see figure 42).



Removing the Drive Axle Shaft  
FIGURE 42

## 5. PreSet Wheel Hubs – Recommended Service

7. Place a container under the hubcap, or drive axle shaft for a drive hub, to receive the draining oil, then remove the hubcap or drive axle shaft. Do not reuse the oil. Correctly dispose of the lubricant.
8. Examine the spindle nut to determine the type of locking system. Disengage the locking device.

### WARNING

Do not loosen the axle spindle nuts by either striking them directly with a hammer, or striking a drift or chisel placed against them. Damage to the parts will occur causing possible loss of axle wheel-end components and serious personal injury.

9. Remove the spindle nut system.
10. Slide the hub off the spindle. Remove and save the outer bearing cone. Be careful when you remove the hub that you do not damage the outer bearing by dropping it on the floor.
  - If the hub is difficult to remove because the seal or bearings are stuck on the spindle, use a mechanical puller to remove the hub (see figure 43).
  - If part of the seal remains on the spindle, carefully remove the part of the seal that remains on the spindle.

### NOTE

This can be done by striking the remaining portion of the seal with the round end of a ball-peen hammer. Use caution not to damage the seal journal on the spindle.

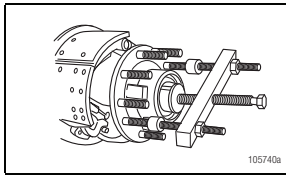

FIGURE 43

11. Place the hub on its outboard end and remove the seal. Retain the seal if it needs to be returned for warranty consideration.
12. Remove the inner bearing cone and spacer (see figure 44).

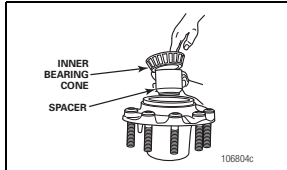

FIGURE 44

### COMPONENT INSPECTION AND REPLACEMENT HAZARD ALERT MESSAGES

Read and observe all hazard alert messages in this publication. They provide information that can help prevent serious personal injury, damage to components, or both.

### WARNING

To prevent serious eye injury, always wear safe eye protection when you perform vehicle maintenance or service.

Observe all warnings and cautions provided by the press manufacturer to avoid damage to components and serious personal injury.

Do not hit steel parts with a steel hammer. Pieces of a part can break off. Serious personal injury and damage to components can result. Use a brass or synthetic mallet for assembly and disassembly procedures.

Solvent cleaners can be flammable, poisonous and cause burns. Examples of solvent cleaners are carbon tetrachloride, and emulsion-type and petroleum-base cleaners. Read the manufacturer's instructions before using a solvent cleaner, then carefully follow the instructions. Also follow the procedures below.

- Wear safe eye protection.
- Wear clothing that protects your skin.
- Work in a well-ventilated area.
- Do not use gasoline or solvents that contain gasoline. Gasoline can explode.
- You must use hot solution tanks or alkaline solutions correctly. Read the manufacturer's instructions before using hot solution tanks and alkaline solutions. Then carefully follow the instructions.

### CAUTION

Do not use hot solution tanks or water and alkaline solutions to clean ground or polished parts. Damage to parts can result.

## 5. PreSet Wheel Hubs – Recommended Service

### CLEAN AND DRY COMPONENTS

#### Worn or Damaged Components

#### WARNING

Do not repair or recondition wheel-end components. Replace damaged, worn or out-of-specification components. Do not mill or machine any components. Using repaired, reconditioned, damaged or worn components can cause wheel end failure, which can result in serious injury and property damage.

#### Hub and Component Cleaning

1. Use a clean filtered solvent to clean the hub and all wheel end components.
2. Do NOT clean ground or polished parts in a hot solution tank or with water, steam or alkaline solutions. These solutions will cause corrosion of the parts.
3. Clean and inspect the wheel bearing cups and cones, race, spindle bearing and seal journals on the spindle and hub. Bearings should be cleaned with clean filtered solvent and dried with either compressed air or a lint-free rag.

#### CAUTION

If compressed air is used, do not spin dry the bearings. The rollers may score due to lack of lubricant and rollers could come off which can result in serious injury. Ensure that the air line is moisture free.

4. Clean and inspect the spindle. Be sure to clean the full length of the seal journal on the spindle.
5. Parts must be dried immediately after cleaning. Dry parts with clean paper towels or rags, or compressed air. Do not dry bearings by spinning with compressed air.

6. Apply a light oil to cleaned and dried parts that are not damaged and are to be immediately assembled. Use only the type of oil used by the manufacturer. Do NOT apply oil to the brake linings or the brake drums.
7. If the parts are to be stored, apply a good corrosion preventative to all surfaces. Do NOT apply the material to the brake linings or the brake drums. Store the parts inside special paper or other material that prevents corrosion.

### INSPECTING BEARING CUPS AND CONES AND BEARING SPACER

#### NOTE

PreSet and PreSet Plus hubs use a precision-machined spacer in conjunction with specially toleranced bearings to control wheel end play. ConMet recommends installing a new PreSet/PreSet Plus service kit when inspection indicates that component replacement is necessary. PreSet/PreSet Plus service kits are available from a parts dealer or distributor.

#### CAUTION

If you choose to reuse existing bearings at this service, they must be inspected in accordance with the bearing manufacturers recommended guidelines.

#### CAUTION

If this inspection indicates that existing bearing component(s) must be replaced, bearing cups and cones must be replaced as a set. Whenever new bearings are installed, replacement of the bearing spacer is also recommended.

1. After components have been properly cleaned, visually inspect the cups, cones and spacer for any wear or damage.

Reference TMC RP644 for proper component inspection procedures.

- Bearing spacers should be visually inspected for signs of wear or damage. Carefully inspect the machined ends of the bearing spacer. Wear to the bearing spacer can appear as a sharp ring of standing metal at either edge of the machined surfaces (see figure 45). Replace the spacer if it has visible wear evidenced by a raised edge on the machined end.

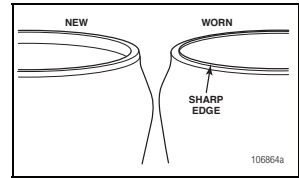

Bearing Spacer Wear  
FIGURE 45

2. If removal or replacement is required, follow the steps outlined below.

### REMOVING CUPS IN ALUMINUM HUBS

1. If the bearing cup must be removed from an aluminum hub, remove it by welding a large bead around the bearing surface of the steel cup, letting the assembly cool, and removing the bearing cup (see figure 46).

#### NOTE

If a welder is not available, heat the hub in an oven to a temperature not to exceed 300°F and pound out the bearing cups with a hammer and mild steel bar, being careful not to damage the hub.

## 5. PreSet Wheel Hubs – Recommended Service

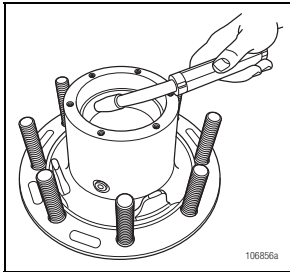

Welding Bead  
FIGURE 46

- Inspect the bearing cup bore for evidence of cup rotation or spun cups.
  - If cup rotation exists, replace the hub.

### REMOVING CUPS IN IRON HUBS

- On an iron hub, remove the bearing cup using a large hammer and a mild steel bar or a hydraulic press. Take precaution to avoid damaging the bearing cup bore and shoulder.
- Inspect the bearing cup bore for evidence of cup rotation or spun cups.
  - If cup rotation exists, replace the hub.

### INSTALLING A NEW CUP IN ALUMINUM HUBS

To install a new cup in an aluminum hub, it is recommended that the hub be heated in boiling water (212°F) or in an oven at a temperature not to exceed 300°F. Cooling the cup in a freezer to 32°F or below will further ease the installation.

#### ⚠ WARNING

Do not overheat the hub as it may degrade the heat-treated strength of the hub. Do not heat the hub with a torch or open flame.

Remove the aluminum hub from the oven or water and carefully drop in the new bearing cup being certain it is fully seated. If the cup is loose, allow a few seconds for it to heat up and secure itself before moving the hub. Use a 0.001" to 0.002" feeler gauge to ensure the cup is fully seated against the shoulder of the bearing bore.

### INSTALLING A NEW CUP IN IRON HUBS

Iron hubs do not need to be heated for bearing cup installation. Press the bearing cup into the hub, being certain that it is fully seated (see figure 47). Use a 0.001" to 0.002" feeler gauge to ensure the cup is fully seated against the shoulder of the bearing bore.

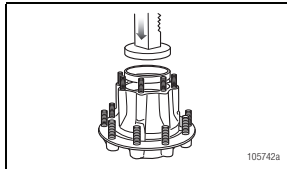

Bearing Cup Pressed into Hub  
FIGURE 47

### WHEEL STUDS

Replace all wheel studs that have damaged or distorted threads, are broken or bent, or are badly corroded. Also, replace both studs adjacent to the damaged stud. If two or more studs have damage, replace all the studs in the hub. Broken studs are usually an indication of excessive or inadequate wheel nut torque.

### STUD REMOVAL

#### ⚠ WARNING

Observe all warnings and cautions for press operation provided by the press manufacturer to avoid serious personal injury and damage to components.

- Place the clean hub in a shop press with the hub supported evenly around and adjacent to the stud being removed.

#### ⚠ WARNING

Failure to adequately support the hub can result in physical injury and/or damage to the hub.

Some hubs are configured so it is impractical to have supports to prevent the hub from tipping when force is applied to the stud. In this case, support the hub on wood blocks on the floor and use a heavy hammer to drive the studs out with several sharp blows. Be careful to avoid damaging the hub and components, particularly the seal bore and the ABS tone ring.

- Press the stud out of the hub.

### STUD REPLACEMENT

#### ⚠ CAUTION

On the ball seat wheel mounting system, always use left-handed threaded studs, which are gold in color and have an "L" stamped on the end, in the hub on the driver's side of the equipment, and use right-handed threaded studs, which are silver in color and have an "R" stamped on the end, in the hub on the passenger's side of the equipment. The ConMet part number is located on the head of the stud. The same part number must be used for replacement unless changing the drum or wheel type.

- To install a new stud, support the hub evenly around and adjacent to the stud being installed.
- Press the new stud all the way into the hub. Be sure the stud is fully seated and that the stud head is not embedded into the hub.



# 5. PreSet Wheel Hubs – Recommended Service

**⚠ WARNING**

Excessive force can cause the stud head to be embedded into the hub, which can create a crack in the hub, resulting in serious injury and property damage. If a stud head is embedded in a hub, replace the hub.

## HUB, DRUM AND WHEEL INSPECTION

1. Inspect the drum pilots, wheel pilots, and mounting face on the hub for damage. A damaged drum pilot is usually caused by improper drum mounting. A damaged wheel pilot could be the result of inadequate wheel nut torque, allowing the wheels to slip in service. Also, inspect other surfaces of the hub for signs of cracks or damage.
2. Inspect the wheels and brake drum for damage.

**⚠ WARNING**

Do not repair or recondition wheel-end components. Replace damaged, worn or out-of-specification components. Do not mill or machine any components. Using repaired, reconditioned, damaged or worn components can cause wheel end failure, which can result in serious injury and property damage.

## ABS TONE RING INSPECTION (AS APPLICABLE)

The Anti-Lock Braking System (ABS) signals acts like any signal generator where the magnet passes a coil and generates a current. On hubs, the toothed ring passes a sensor and generates a signal that is sent to the ABS computer. There are four types of ABS rings used on ConMet hubs — machined, stamped steel, bolt on and snap-in (see figure 48).

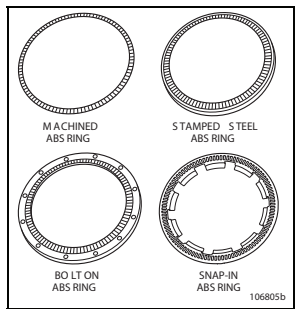
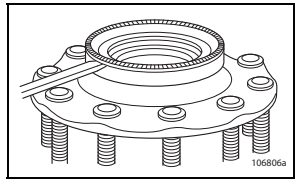

FIGURE 48

If the tone ring is damaged (for example, if it is dropped, bent, chipped or dinged), it must be replaced. For a list of replacement ABS rings, refer to the Service Parts List in the back of this section.

## REMOVAL AND INSTALLATION OF MACHINED ABS TONE RING

For a machined metal ring, remove using a chisel, making sure not to damage the hub (see figure 49). Reinstall by pressing the ring on until it bottoms out on hub.



Machined ABS Ring  
FIGURE 49

## REMOVAL AND INSTALLATION OF STAMPED STEEL ABS TONE RING

1. The steer axle tone ring can be removed by gripping the ring with a pair of locking pliers and tapping the pliers upward with a rubber mallet. Work around the ring to keep the ring from cocking (see figure 50). Drive axle and trailer tone rings can be removed by gripping the ring with a pair of locking pliers and prying against the head of a wheel stud to lift the ring off the hub. Work around the ring to prevent cocking (see figure 51).

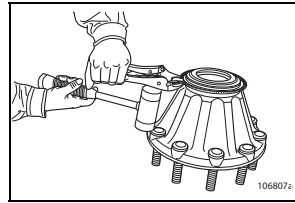

Stamped Steel ABS Ring  
FIGURE 50

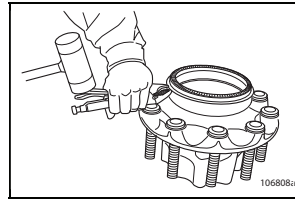

Stamped Steel ABS Ring  
FIGURE 51

## 5. PreSet Wheel Hubs – Recommended Service

2. Thoroughly clean and degrease the ABS ring seat on the hub with a nonflammable solvent.

### CAUTION

Replace the hub if the ABS ring seat is damaged.  
The ABS ring must be fully seated with a maximum of 0.008" axial runout to ensure the ABS system functions properly.

3. Place the hub in a press and place the ABS ring on the hub ring seat.
4. Using ConMet ring installation tool (part number 107119), center the tool over the ABS ring. Each type of ring fits a corresponding diameter on the tool (see figure 52).

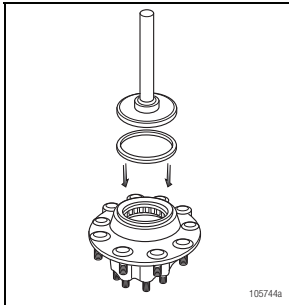

Installing the ABS Tone Ring  
FIGURE 52

5. Press the ring on the hub. If a press is not available, drive the ring on with a hammer or mallet until the ring seats on the hub (see figure 53). A swift initial blow with an 8-lb. hammer may be necessary to start the ring onto the hub.

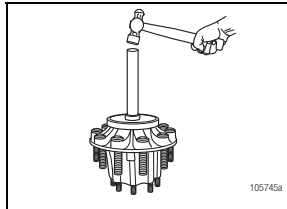

Using a Hammer to Install the Ring  
FIGURE 53

6. Inspect the ring to ensure proper seating. If the ring is not completely seated, continue to drive the ring with the ring installation tool until it is completely seated.

### REMOVAL AND INSTALLATION OF BOLT ON ABS TONE RINGS (For Disc Brakes)

1. Remove and discard the fasteners holding the ABS tone ring on the hub.
2. Thoroughly clean and degrease the ABS ring seat on the hub with a non-flammable solvent.
3. Install the new ABS ring using the new fasteners included with the ring. Torque the fasteners to the torque specifications below.

Thread Size	Torque
#8-32	18-22 in-lbs
1/4"-20	125-135 in-lbs

# 5. PreSet Wheel Hubs – Reassembly

## PreSet WHEEL HUBS

**⚠ CAUTION**

When using an oil bath system, do not pack the bearing with grease. Grease will prevent the proper circulation of axle lubricant and can cause premature wheel seal and bearing failure.

1. Place the hub, seal end up, on a clean work bench surface.
2. Lubricate the inner bearing cone with the same lubricant as will be used in the hub and install it into the inner bearing cup (see figure 55).

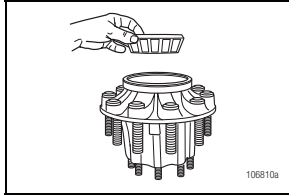

Bearing Cone Assembly  
FIGURE 55

3. Use a clean applicator to lightly lubricate the seal bore of the hub.

**NOTE**

Only several drops of oil are needed to lubricate the seal bore and inner diameter. Using excess lubricant could result in a false leak diagnosis when undergoing inspection.

**NOTE**

The seal must be replaced every time the hub is removed from the spindle. Do not apply any gasket sealant to the seal outer or inner diameter. Always use the seal installation tool specified by the seal manufacturer. Using an improper tool can distort or damage the seal and cause premature seal failure.

4. Position the seal into the hub bore. Use a ConMet seal installation tool or flat plate and a small mallet to install the seal.

**NOTE**

ConMet seals require the proper tool for installation. Refer to the table below for a ConMet seal installation tool or flat plate dimensions. For other seals, refer to the specific manufacturers' instructions.

ConMet Seal Installation Tools

Axle Type	Part Number
FF Steer	10084010
FL Steer	10084011
R-Drive	10084012
TN-Trailer	10084013
TP-Trailer	10084013

Flat Plate Dimensions

Application	Seal Part Number	Min. Dia.	Max. Dia.
FF Steer	10045885	4.45"	4.65"
FL Steer	10045883	5.2"	5.4"
R-Drive	10045887	5.6"	5.85"
TN-Trailer	10045888	5.6"	5.85"
TP-Trailer	10045889	5.6"	5.85"

5. When installing the ConMet seal, tap the adapter plate of the installation tool or flat plate around the outer edge to position the seal. Drive the wheel seal into place (see figure 56).

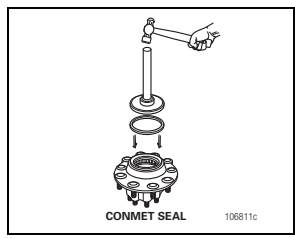

FIGURE 56

6. Check to be certain the seal is uniformly bottomed out in hub bore and that the seal inner diameter and the inner bearing turn freely.

**⚠ CAUTION**

Failure to lubricate the inner diameter of the seal may result in premature seal failure.

7. Lubricate the inner diameter of the seal with a light film of the same lubricant as will be used in the hub.
8. Turn the hub over, and place it seal end down. Install a bearing spacer. If the spacer has a tapered end, it should face towards the outboard end of the hub (see figure 57).

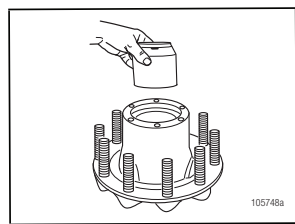

Installing the Spacer  
FIGURE 57

9. Lubricate the outer bearing cone with the same lubricant as will be used in the hub and install it into the hub assembly (see figure 58).

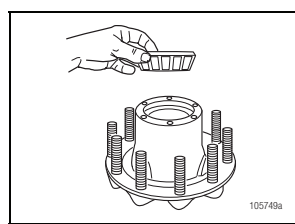

Installing the Outer Bearing Cone  
FIGURE 58

## 5. PreSet Wheel Hubs – Reinstallation

### INSTALLING THE PreSet WHEEL HUB ASSEMBLY

#### Spindle Preparation

1. Clean the spindle to remove any lubricant, corrosion prevention coating, foreign material, or surface rust that may be present. Be sure to clean the full length of the seal journal.
2. Lubricate the bearing journals on the spindle, or the inside diameter of the bearing cones with Grade 2 grease or the lubricant that will be used in the wheel end. Do not coat the seal journal on the spindle.
3. Lubricate the inside diameter of the seal with the same lubricant that will be used in the wheel end.

#### CAUTION

Failure to apply lubricant to the bearing journals will result in fretting corrosion, which may result in difficulty removing the bearing. Never support the hub on the spindle with just the inner bearing and seal. This can damage the seal and cause premature failure, i.e., by cocking the seal in the bore.

#### Mounting the Hub

4. Mount the hub assembly onto the axle spindle with a smooth, firm motion while holding the outer bearing in place. Use care to maintain alignment between the bearing cones, spacer, and spindle and to avoid seal damage (see figure 59).

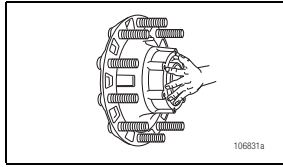

Mounting the Assembly  
FIGURE 59

#### Spindle Nut Torque

5. One-Piece Spindle Nut System (For example: Pro-Torq<sup>®</sup>, Zip-Torq<sup>®</sup> and Axilok<sup>®</sup>)
  - If a one-piece spindle nut system is being used, torque the nut to a minimum of 300 ft-lbs (150 ft-lbs for PreSet FC medium duty steer). Do not back off the spindle nut. Advance as necessary to engage any locking device.
6. Double Nut or Jam Nut System
  - If a double nut or jam nut system is being used, torque the inner nut to 300 ft-lbs (150 ft-lbs for PreSet FC medium duty steer). Do not back off the spindle nut. Advance the inner nut as necessary to install the locking ring. Install the outer nut with 200 ft-lbs (100 ft.-lbs. for PreSet FC) of torque. Be sure to engage any locking device.

#### NOTE

ConMet does not recommend a one-piece "castellated" type nut system for use with PreSet hubs.

#### NOTE

The hubcap bolt holes must be free of debris, such as silicone gasket sealer to ensure the bolts will tighten properly to avoid leaks. Silicone trapped in the hubcap screw holes can create hydraulic pressures during hubcap screw installation, leading to premature hub failure through the hubcap holes. The vent should also be clean and free of debris. Remove any burrs or sharp edges. Always use new gaskets.

7. Install the hub cap or drive axle with a new gasket. Torque the hub cap bolts in a star pattern to 12 to 18 ft-lbs. Torque the drive axle bolts or nuts per the drive axle manufacturer's recommendation.

#### NOTE

Use SAE Grade 5 bolts or stronger. Do not use star washers. Use only flat washers or split washers.

## 5. PreSet Wheel Hubs – Service Parts

### Axle Designations

Designation	Typical Axle Rating (lbs)	Comments
<b>Steer Axle</b>		
FC Steer	8,000	Medium duty
FF Steer	12,000-14,700	Standard linehaul axle. Comes in two spindle variations 1. Flat locking feature with 12 threads/inch. 2. Keyway locking feature with 18 threads/inch.
FL Steer	20,000	Vocational applications
<b>Drive axle</b>		
L-Drive (190)	19,000	Medium duty
R-Drive	20,000-23,000	Standard linehaul axle
<b>Trailer Axle</b>		
TN Trailer	22,500	Tapered spindle
TP Trailer	25,000	Parallel spindle or "Propar"

**NOTE:** These axle ratings are to be used as a reference only. Refer to the vehicle's door plate for your specific application.

### PreSet Service Kits and Components

PreSet Hubs	Rebuild Kit	Seal and Spacer Kit	Magnetic Fill Plug
FC Steer	10037697	10084179	N/A
FF Flat	10081727	10081518	N/A
FF Keyway	10081727	10081518	N/A
FL Steer	10081728	10081519	N/A
F-Drive	10081076	N/A	N/A
L-Drive (190)	10037961	10084178	10033073
R-Drive	10081729	10081520	10033073
TN (Tapered)	10081730	10081521	10033073
TP (Straight)	10081731	10081522	10033073

Rebuild kit includes seal, bearing spacer, inner cup and cone, outer cup and cone.

Seal and spacer kit includes seal and bearing spacer.

#### NOTE

Bearing cups and cones must be replaced as a set.

#### NOTE

When bearings are replaced in any PreSet hub, it is recommended that the bearing spacer be replaced as well.

### ConMet Seals

Position	Spindle Type	Aftermarket Part Number
Steer	FF Spindle	10045885
	FL Spindle	10045883
	FC Spindle	10088276
Drive	R Spindle	10045887
	L/190 Spindle	10084180
Trailer	TP Spindle	10045889
	TN Spindle	10045888

## 5. PreSet Wheel Hubs – Service Parts

### ConMet Seal Installation Tools

Axle Designation	Installation Tool Part Number	Minimum Diameter*	Maximum Diameter*
FF Steer	10084010	4.45"	4.65"
FL Steer	10084011	5.2"	5.4"
R-Drive	10084012	5.6"	5.85"
TN Trailer	10084013		
TP Trailer	10084013		

\*Required flat plate dimensions if you are not using a ConMet installation tool (minimum of 3/8", 9.5 mm thick).

### Approved PreSet Aftermarket Bearings

Description	ConMet Number	Bearing Set Number
<b>FC Steer Axle</b>		
Inner Cup & Cone	10037695	Not available in sets
Outer Cup & Cone	10037696	
<b>FF Steer Axle</b>		
Inner Cup & Cone	10041905	Set 427
Outer Cup & Cone	10041906	Set 428
<b>FL Steer Axle</b>		
Inner Cup & Cone	10041925	Set 445
Outer Cup & Cone	10041926	Set 446
<b>L-Drive (190) Axle</b>		
Inner Cup & Cone	10037959	Not available in sets
Outer Cup & Cone	10037960	
<b>R-Drive Axle</b>		
Inner Cup & Cone	10041915	Set 429
Outer Cup & Cone	10041916	Set 430
<b>TN Trailer Axle</b>		
Inner Cup & Cone	10041935	Set 431
Outer Cup & Cone	10041905	Set 427
<b>TP Trailer Axle</b>		
Inner Cup & Cone	10041945	Set 432
Outer Cup & Cone	10041945	Set 432

## 5. Preset Wheel Hubs – Service Parts

### ABS Rings for ConMet Hubs (for reference only)

Axle	Material	Type of Brake	Hub Casting Number	ABS Ring Part Number
FC Steer	Iron	Drum	10016569	10016586
FF Steer	Aluminum	Disc	10016331	10009780
			10018723	10009780
			10020207	10009780
	Aluminum	Drum	101945	10009780
			103110	10009780
			104112	10009780
			10000776	10009780
	Iron	Disc	10011945	10009780
		Disc	10019965	10023558
		Iron	Drum	10005604
FL Steer	Aluminum	Drum	10012265	10019840
	Iron	Disc	10005561	107912
L-Drive (190)	Iron	Disc	10020602	10023559
		Drum	10020627	10023757
R-Drive	Aluminum	Disc	10016328	103705
		Drum	10001280	103705
	Iron	Drum	10001387	103705
			10018310	103705
			10018311	103705
TN Trailer	Aluminum	Drum	102035	105459
TP Trailer	Aluminum	Disc	10016620	10019896
		Drum	10001216	105459
	Iron	Drum	10025633	10023829

**NOTE**

If an ABS ring is not listed for a particular hub, contact ConMet Customer Service at 800-547-9473.

## 6. PreSet Plus Wheel Hubs – Recommended Service

### PreSet Plus® Hub Assemblies

ConMet PreSet Plus hub assemblies feature the same PreSet technology and include the same precision-machined hubs, premium seals and specially toleranced roller bearings. However, PreSet Plus hubs incorporate the following:

- An integrated spindle nut that eases installation and disassembly and protects components during wheel end service
- An optimized spacer
- Standard magnetic fill plug

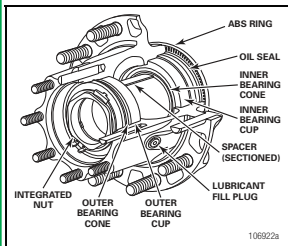

PreSet Plus Hub and Components  
FIGURE 60

When inspections indicate that service is necessary on a PreSet Plus hub, follow the recommended service, inspection, reassembly and reinstallation instructions found in the following section.

In order to ensure optimum wheel hub performance, ConMet recommends that only approved PreSet Plus service parts be used to replace all critical components of the system. Refer to the back of this section for a listing of approved parts.

### HUB REMOVAL AND DISASSEMBLY

#### WARNING

Vehicles on jacks can fall, causing serious personal injury or property damage. Never work under a vehicle supported by a jack without supporting the vehicle with stands and blocking the wheels. Wear safe eye protection.

1. Park the vehicle on a level surface. Block the wheels to prevent the vehicle from moving.
2. Raise the axle until the tires are off the floor.
3. Place safety stands under the trailer frame or under each axle spring seat (see figure 61).

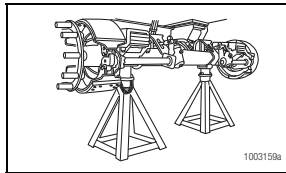

FIGURE 61

4. Remove the tire and wheel assembly using procedures specified by the wheel manufacturer (see figure 62).

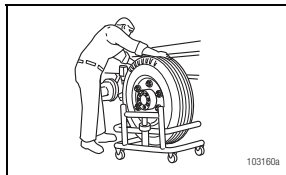

FIGURE 62

#### WARNING

Sudden release of compressed air can cause serious personal injury and damage to components.

Before you service a spring chamber, carefully follow the manufacturer's instructions to compress and lock the spring to completely release the brake. Verify that no air pressure remains in the service chamber before you proceed.

5. If the axle is equipped with spring brake chambers, carefully compress and lock the springs so that they cannot actuate (see figure 63).

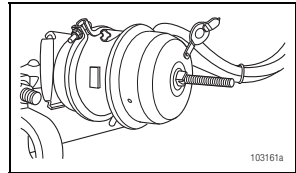
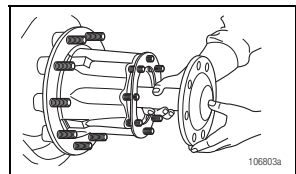

FIGURE 63

6. For drum brakes, remove the brake drum. Support the drum during the removal process to prevent damage to the components. For disc brakes, remove caliper per manufacturers' recommended procedure.

#### NOTE

If the hub to be disassembled is a drive hub, remove the drive axle shaft, and capture the oil (see figure 64).



Removing the Drive Axle Shaft  
FIGURE 64



# 6. PreSet Plus Wheel Hubs – Recommended Service

- Place a container under the hubcap, or drive axle shaft for a drive hub, to receive the draining oil, then remove the hubcap or drive axle shaft. Do not reuse the oil. Correctly dispose of the lubricant.
- Remove the red locking ring. Use caution not to damage the locking ring. Do not remove the spiral snap ring that holds the spindle nut in the hub.

**WARNING**

Do not loosen the axle spindle nuts by either striking them directly with a hammer, or striking a drift or chisel placed against them. Damage to the parts will occur causing possible loss of axle wheel-end components and serious personal injury.

- Use a breaker bar to loosen the spindle nut. PreSet Plus spindle nut installation torque is 300 ft-lbs for steer hubs and 500 ft-lbs for drive and trailer hubs.

**NOTE**

Use only 6-point forged sockets for installation and removal of PreSet Plus spindle nuts.

Socket Sizes for PreSet Plus Spindle Nuts

Spindle Nut	Socket Size (6 Point)
FF Flat	2"
FF Keyway	2"
FL	2 3/4"
R	3 3/4"
TN	3 1/8"
TP	4"

- After the spindle nut is initially loosened with a breaker bar, loosen the spindle nut to remove the hub from the spindle. The internal snap ring will act as a hub puller and will aid in removal of the hub from the spindle. Do not exceed 50

ft-lbs of torque when removing the hub from the spindle. If the hub will not come off of the spindle without exceeding this torque value, remove the spiral snap ring (see figure 65) and the spindle nut assembly and use a conventional hub puller to remove the hub from the spindle.

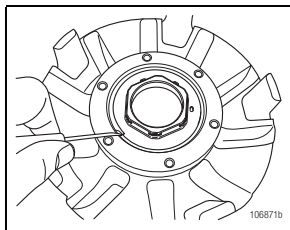

Spiral Snap Ring Removal  
FIGURE 65

- Slide the hub off the spindle. Remove and save the outer bearing cone. Be careful when you remove the hub that you do not damage the outer bearing by dropping it on the floor.

- If the hub is difficult to remove because the seal is stuck on the spindle, use a mechanical puller to remove the hub (see figure 66).
- If part of the seal remains on the spindle, carefully remove the part of the seal that remains on the spindle.

**NOTE**

This can be done by striking the remaining portion of the seal with the round end of a ball-peen hammer. Use caution not to damage the seal journal on the spindle.

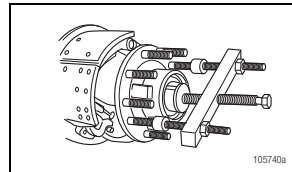
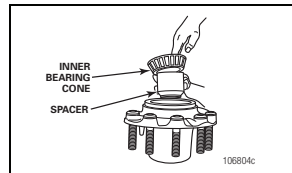

FIGURE 66

- Place the hub on its outboard end and remove the seal. Retain the seal if it needs to be returned for warranty consideration.
- Remove the inner bearing cone and spacer (see figure 67).



Hub Disassembly  
FIGURE 67

## 6. PreSet Plus Wheel Hubs – Recommended Service

### COMPONENT INSPECTION AND REPLACEMENT HAZARD ALERT MESSAGES

Read and observe all hazard alert messages in this publication. They provide information that can help prevent serious personal injury, damage to components, or both.

#### WARNING

To prevent serious eye injury, always wear safe eye protection when you perform vehicle maintenance or service.

Observe all warnings and cautions provided by the press manufacturer to avoid damage to components and serious personal injury.

Do not hit steel parts with a steel hammer. Pieces of a part can break off. Serious personal injury and damage to components can result. Use a brass or synthetic mallet for assembly and disassembly procedures.

Solvent cleaners can be flammable, poisonous and cause burns. Examples of solvent cleaners are carbon tetrachloride, and emulsion-type and petroleum-base cleaners. Read the manufacturer's instructions before using a solvent cleaner, then carefully follow the instructions. Also follow the procedures below.

- Wear safe eye protection. Wear clothing that protects your skin.
- Work in a well-ventilated area. Do not use gasoline or solvents that contain gasoline. Gasoline can explode.
- You must use hot solution tanks or alkaline solutions correctly. Read the manufacturer's instructions before using hot solution tanks and alkaline solutions. Then carefully follow the instructions.

#### CAUTION

Do not use hot solution tanks or water and alkaline solutions to clean ground or polished parts. Damage to parts can result.

### CLEAN AND DRY COMPONENTS

#### *Worn or Damaged Components*

#### WARNING

Do not repair or recondition wheel-end components. Replace damaged, worn or out-of-specification components. Do not mill or machine any components. Using repaired, reconditioned, damaged or worn components can cause wheel end failure, which can result in serious injury and property damage.

#### *Hub and Component Cleaning*

1. Use a clean filtered solvent to clean the hub and all wheel end components.
2. Do NOT clean ground or polished parts in a hot solution tank or with water, steam or alkaline solutions. These solutions will cause corrosion of the parts.
3. Clean and inspect the wheel bearing cups and cones, race, spindle bearing and seal journals on the spindle and hub. Bearings should be cleaned with clean filtered solvent and dried with either compressed air or a lint-free rag.

#### CAUTION

If compressed air is used, do not spin dry the bearings. The rollers may score due to lack of lubricant and rollers could come off which can result in serious injury. Ensure that the air line is moisture free.

4. Clean and inspect the spindle. Be sure to clean the full length of the seal journal on the spindle.
5. Parts must be dried immediately after cleaning. Dry parts with clean paper towels or rags, or compressed air. Do not dry bearings by spinning with compressed air.

6. Apply a light oil to cleaned and dried parts that are not damaged and are to be immediately assembled. Use only the type of oil used by the manufacturer. Do NOT apply oil to the brake linings or the brake drums.
7. If the parts are to be stored, apply a good corrosion preventative to all surfaces. Do NOT apply the material to the brake linings or the brake drums. Store the parts inside special paper or other material that prevents corrosion.

### INSPECTING BEARING CUPS AND CONES AND BEARING SPACER

#### **NOTE**

PreSet and PreSet Plus hubs use a precision-machined spacer in conjunction with specially tolerated bearings to control wheel end play. ConMet recommends installing a new PreSet/PreSet Plus service kit when inspection indicates that component replacement is necessary. PreSet/PreSet Plus service kits are available from a parts dealer or distributor.

#### CAUTION

If you choose to reuse existing bearings at this service, they must be inspected in accordance with the bearing manufacturers recommended guidelines.

#### CAUTION

If this inspection indicates that existing bearing component(s) must be replaced, bearing cups and cones must be replaced as a set. Whenever new bearings are installed, replacement of the bearing spacer is also recommended.

## 6. PreSet Plus Wheel Hubs – Recommended Service

- After components have been properly cleaned, visually inspect the cups, cones and spacer for any wear or damage. Reference materials for proper bearing inspection procedures are available from the bearing manufacturers.
  - Bearing spacers should be visually inspected for signs of wear or damage. Carefully inspect the machined ends of the bearing spacer. Wear to the bearing spacer can appear as a sharp ring of standing metal at either edge of the machined surfaces (see figure 68). Replace the spacer if it has visible wear evidenced by a raised edge on the machined end.

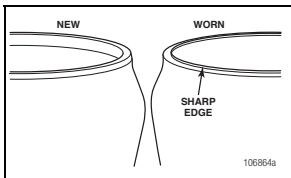

Bearing Spacer Wear  
FIGURE 68

- If removal or replacement is required, follow the steps outlined below.

### REMOVING CUPS IN ALUMINUM HUBS

- If the bearing cup must be removed from an aluminum hub, remove it by welding a large bead around the bearing surface of the steel cup, letting the assembly cool, and removing the bearing cup (see figure 69).

**NOTE**

If a welder is not available, heat the hub in an oven to a temperature not to exceed 300°F and pound out the bearing cups with a hammer and mild steel bar, being careful not to damage the hub.

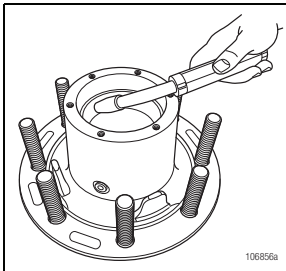

Welding Bead  
FIGURE 69

- Inspect the bearing cup bore for evidence of cup rotation or spun cups.
  - If cup rotation exists, replace the hub.

### REMOVING CUPS IN IRON HUBS

- On an iron hub, remove the bearing cup using a large hammer and a mild steel bar or a hydraulic press. Take precaution to avoid damaging the bearing cup bore and shoulder.
- Inspect the bearing cup bore for evidence of cup rotation or spun cups.
  - If cup rotation exists, replace the hub.

### INSTALLING A NEW CUP IN ALUMINUM HUBS

To install a new cup in an aluminum hub, it is recommended that the hub be heated in boiling water (212°F) or in an oven at a temperature not to

exceed 300°F. Cooling the cup in a freezer to 32°F or below will further ease the installation.

**WARNING**

Do not overheat the hub as it may degrade the heat-treated strength of the hub. Do not heat the hub with a torch or open flame.

Remove the aluminum hub from the oven or water and carefully drop in the new bearing cup being certain it is fully seated. If the cup is loose, allow a few seconds for it to heat up and secure itself before moving the hub. Use a 0.001" to 0.002" feeler gauge to ensure the cup is fully seated against the shoulder of the bearing bore.

### INSTALLING A NEW CUP IN IRON HUBS

Iron hubs do not need to be heated for bearing cup installation. Press the bearing cup into the hub, being certain that it is fully seated (see figure 70). Use a 0.001" to 0.002" feeler gauge to ensure the cup is fully seated against the shoulder of the bearing bore.

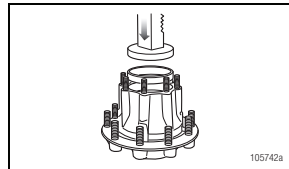

Bearing Cup Pressed into Hub  
FIGURE 70

### WHEEL STUDS

Replace all wheel studs that have damaged or distorted threads, are broken or bent, or are badly corroded. Also, replace both studs adjacent to the damaged stud. If two or more studs have damage, replace all the studs in the hub. Broken studs are usually an indication of excessive or inadequate wheel nut torque.

## 6. PreSet Plus Wheel Hubs – Recommended Service

### STUD REMOVAL

#### ⚠ WARNING

Observe all warnings and cautions for press operation provided by the press manufacturer to avoid serious personal injury and damage to components.

1. Place the clean hub in a shop press with the hub supported evenly around and adjacent to the stud being removed.

#### ⚠ WARNING

Failure to adequately support the hub can result in physical injury and/or damage to the hub.

Some hubs are configured so it is impractical to have supports to prevent the hub from tipping when force is applied to the stud. In this case, support the hub on wood blocks on the floor and use a heavy hammer to drive the studs out with several sharp blows. Be careful to avoid damaging the hub and components, particularly the seal bore and the ABS tone ring.

2. Press the stud out of the hub.

### STUD REPLACEMENT

#### ⚠ CAUTION

On the ball seat wheel mounting system, always use left-handed threaded studs, which are gold in color and have an "L" stamped on the end, in the hub on the driver's side of the equipment, and use right-handed threaded studs, which are silver in color and have an "R" stamped on the end, in the hub on the passenger's side of the equipment. The ConMet part number is located on the head of the stud. The same part number must be used for replacement unless changing the drum or wheel type.

1. To install a new stud, support the hub evenly around and adjacent to the stud being installed.
2. Press the new stud all the way into the hub. Be sure the stud is fully seated and that the stud head is not embedded into the hub.

#### ⚠ WARNING

Excessive force can cause the stud head to be embedded into the hub, which can create a crack in the hub, resulting in serious injury and property damage. If a stud head is embedded in a hub, replace the hub.

### HUB, DRUM AND WHEEL INSPECTION

1. Inspect the drum pilots, wheel pilots, and mounting face on the hub for damage. A damaged drum pilot is usually caused by improper drum mounting. A damaged wheel pilot could be the result of inadequate wheel nut torque, allowing the wheels to slip in service. Also, inspect other surfaces of the hub for signs of cracks or damage.
2. Inspect the wheels and brake drum for damage.

#### ⚠ WARNING

Do not repair or recondition wheel-end components. Replace damaged, worn or out-of-specification components. Do not mill or machine any components. Using repaired, reconditioned, damaged or worn components can cause wheel end failure, which can result in serious injury and property damage.

### ABS TONE RING INSPECTION (AS APPLICABLE)

The Anti-Lock Braking System (ABS) signals acts like any signal generator where the magnet passes a coil and generates a current. On hubs, the toothed ring passes a sensor and generates a signal that is sent to the ABS computer. There are four types of ABS rings used on ConMet hubs — machined, stamped steel, bolt on and snap-in (see figure 71).

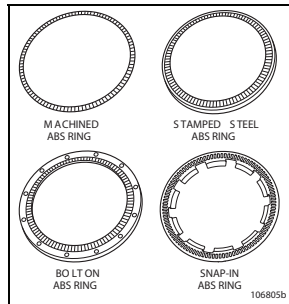
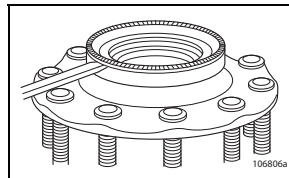

FIGURE 71

If the tone ring is damaged (for example, if it is dropped, bent, chipped or dinged), it must be replaced. For a list of replacement ABS rings, refer to the Service Parts List in the back of this section.

### REMOVAL AND INSTALLATION OF MACHINED ABS TONE RING

For a machined metal ring, remove using a chisel, making sure not to damage the hub (see figure 72). Reinstall by pressing the ring on until it bottoms out on hub.



Machined ABS Ring

FIGURE 72

# 6. PreSet Plus Wheel Hubs – Recommended Service

## REMOVAL AND INSTALLATION OF STAMPED STEEL ABS TONE RING

1. The steer axle tone ring can be removed by gripping the ring with a pair of locking pliers and tapping the pliers upward with a rubber mallet. Work around the ring to keep the ring from cocking (see figure 73). Drive axle and trailer tone rings can be removed by gripping the ring with a pair of locking pliers and prying against the head of a wheel stud to lift the ring off the hub. Work around the ring to prevent cocking (see figure 74).

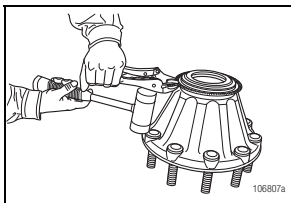

Stamped Steel ABS Ring  
FIGURE 73

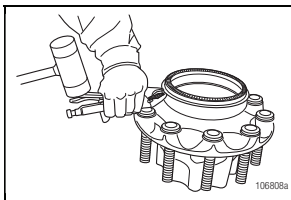

Stamped Steel ABS Ring  
FIGURE 74

2. Thoroughly clean and degrease the ABS ring seat on the hub with a nonflammable solvent.

### CAUTION

Replace the hub if the ABS ring seat is damaged. The ABS ring must be fully seated with a maximum of 0.008" axial runout to ensure the ABS system functions properly.

### NOTE

For steer hubs, be certain the inside diameter flange is facing up.

3. Place the hub in a press and place the ABS ring on the hub ring seat.
4. Using ConMet ring installation tool (part number 107119), center the tool over the ABS ring. Each type of ring fits a corresponding diameter on the tool (see figure 75).

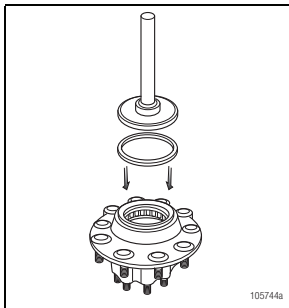

Installing the ABS Tone Ring  
FIGURE 75

5. Press the ring on the hub. If a press is not available, drive the ring on with a hammer or mallet until the ring seats on the hub (see figure 76). A swift initial blow with an 8-lb. hammer may be necessary to start the ring onto the hub.

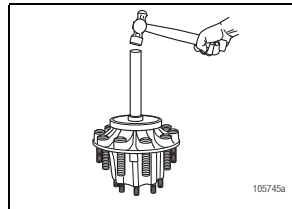

Using a Hammer to Install the Ring  
FIGURE 76

6. Inspect the ring to ensure proper seating. If the ring is not completely seated, continue to drive the ring with the ring installation tool until it is completely seated.

## REMOVAL AND INSTALLATION OF BOLT ON ABS TONE RINGS (For Disc Brakes)

1. Remove and discard the fasteners holding the ABS tone ring on the hub.
2. Thoroughly clean and degrease the ABS ring seat on the hub with a non-flammable solvent.
3. Install the new ABS ring using the new fasteners included with the ring. Torque the fasteners to the torque specifications below.

Thread Size	Torque
#8-32	18-22 in-lbs
1/4"-20	125-135 in-lbs

## 6. PreSet Plus Wheel Hubs – Reassembly

### PreSet Plus WHEEL HUBS

#### CAUTION

When using an oil bath system, do not pack the bearing with grease. Grease will prevent the proper circulation of axle lubricant and can cause premature wheel seal and bearing failure.

1. Place the hub, seal end up, on a clean work bench surface.
2. Lubricate the inner bearing cone with the same lubricant as will be used in the hub and install it into the inner bearing cup (see figure 78).

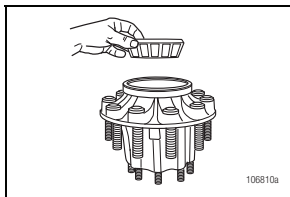

Bearing Cone Assembly  
FIGURE 78

3. Use a clean applicator to lightly lubricate the seal bore of the hub.

#### NOTE

Only several drops of oil are needed to lubricate the seal bore and inner diameter. Using excess lubricant could result in a false seal leak diagnosis when undergoing inspection.

#### NOTE

The seal must be replaced every time the hub is removed from the spindle.

Do not apply any gasket sealant to the seal outer or inner diameter.

Always use the seal installation tool specified by the seal manufacturer. Using an improper tool can distort or damage the seal and cause premature seal failure.

4. Position the seal into the hub bore. Use a ConMet seal installation tool or flat plate and a small mallet to install the seal.

#### NOTE

ConMet seals require the proper tool for installation. Refer to the table below for a ConMet seal installation tool or flat plate dimensions. For other seals, refer to the specific manufacturers' instructions.

#### ConMet Seal Installation Tools

Axle Type	Part Number
FF Steer	10084010
FL Steer	10084011
R-Drive	10084012
TN-Trailer	10084013
TP-Trailer	10084013

#### Flat Plate Dimensions

Application	Seal Part Number	Min. Dia.	Max. Dia.
FF Steer	10045885	4.45"	4.65"
FL Steer	10045883	5.2"	5.4"
R-Drive	10045887	5.6"	5.85"
TN-Trailer	10045888	5.6"	5.85"
TP-Trailer	10045889	5.6"	5.85"

5. When installing the ConMet seal, tap the adapter plate of the installation tool or flat plate around the outer edge to position the seal. Drive the wheel seal into place (see figure 79).

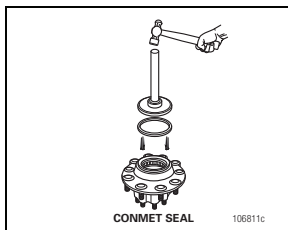

FIGURE 79

6. Check to be certain the seal is uniformly bottomed out in hub bore and that the seal inner diameter and the inner bearing turn freely.

#### CAUTION

Failure to lubricate the inner diameter of the seal may result in premature seal failure.

7. Lubricate the inner diameter of the seal with a light film of the same lubricant as will be used in the hub.
8. Turn the hub over, and place it seal end down. Install a bearing spacer. If the spacer has a tapered end, it should face towards the outboard end of the hub (see figure 80).

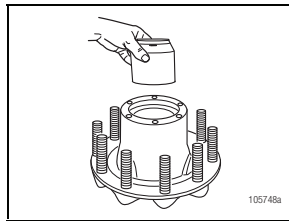

Installing the Spacer  
FIGURE 80

9. Lubricate the outer bearing cone with the same lubricant as will be used in the hub and install it into the hub assembly (see figure 81).

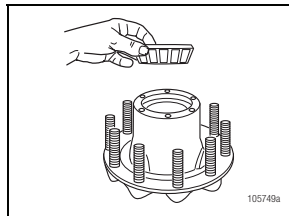

Installing the Outer Bearing Cone  
FIGURE 81

## 6. PreSet Plus Wheel Hubs – Reassembly

### **Spindle Nut and Spiral Snap Ring Reassembly**

1. Seat the flat washer into the back of the spindle nut (see figure 82).

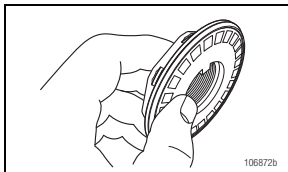

Seating Flat Washer into Spindle Nut  
FIGURE 82

2. Position the spindle nut and washer against the outer bearing (see figure 83).

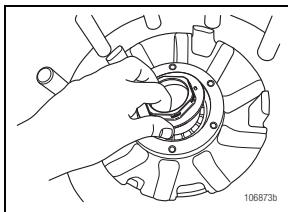

Positioning Nut, Washer Against Bearing  
FIGURE 83

3. Install the spiral snap ring into the snap ring groove in the hub. Make sure that the snap ring is fully seated into the groove in the hub (see figures 84 and 85).

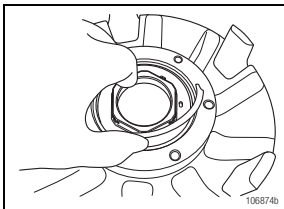

Installing Spiral Snap Ring  
FIGURE 84

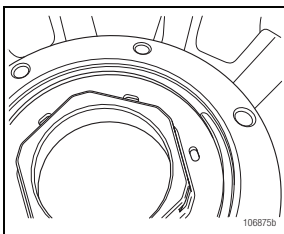

Fully Seating Spiral Snap Ring  
in Groove of Hub  
FIGURE 85

## 6. PreSet Plus Wheel Hubs – Reinstallation

### INSTALLING THE PreSet Plus WHEEL HUB ASSEMBLY

#### WARNING

Failure to fill the hub with the correct amount of lubricant can cause premature failure of the PreSet Plus hub assembly, which, if not avoided, could result in death or serious injury.

#### NOTE

Use the proper hubcap for the type of lubricant intended to be used.

- Clean the spindle to remove any lubricant, corrosion prevention coating, foreign material, or surface rust that may be present.
- Lubricate the bearing journals on the spindle, or the inside diameter of the bearing cones with Grade 2 grease or the lubricant that will be used in the wheel end. Do not coat the seal journal on the spindle.
- Lubricate the inside diameter of the seal with the same lubricant that will be used in the wheel end.
- If present, remove the red locking snap ring from the spindle nut. Verify that the bearing spacer is in proper alignment. Align the key or flat on the washer with the keyway or flat on the spindle as the hub is placed onto the spindle. Use a smooth firm motion and place the hub onto the spindle. When the threads on the nut engage the threads on the spindle, rotate the nut in a clockwise direction to fully engage the threads.
- Torque the spindle nut to the following torque values:
  - Steer Hub – Torque the spindle nut to 300 ft-lbs while rotating the hub. **DO NOT BACK OFF THE SPINDLE NUT.**
  - Drive Hub or Trailer Hub – Torque the spindle nut to 500 ft-lbs while rotating the hub. **DO NOT BACK OFF THE SPINDLE NUT.**

#### Socket Sizes for PreSet Plus Spindle Nuts

Spindle Nut	Socket Size (6 Point)
FF Flat	2"
FF Keyway	2"
FL	2 3/4"
R	3 3/4"
TN	3 1/8"
TP	4"

- Visually examine the three holes in the face of the spindle nut. One of the holes will line up with the holes in the inner washer. Install the tab of the red locking snap ring through the hole in the nut and washer that are aligned. Spread the locking ring, push it over the spindle nut and in to the machined grooves in the spindle nut. Use caution not to bend the locking ring permanently. If the locking ring is damaged or bent, replace it with a new one.
- Install the hub cap or drive axle with a new gasket. Torque the hub cap bolts in a star pattern to 12 to 18 ft-lbs. Torque the drive axle bolts or nuts per the drive axle manufacturer's recommendation.



## 6. PreSet Plus Wheel Hubs – Service Parts

### Axle Designations

Designation	Typical Axle Rating (lbs)	Comments
<b>Steer Axle</b>		
FF Steer	12,000-14,700	Standard linehaul axle. Comes in two spindle variations 1. Flat locking feature with 12 threads/inch. 2. Keyway locking feature with 18 threads/inch.
FL Steer	20,000	Vocational applications
<b>Drive axle</b>		
R-Drive	20,000-23,000	Standard linehaul axle
<b>Trailer Axle</b>		
TN Trailer	22,500	Tapered spindle
TP Trailer	25,000	Parallel spindle or "Propar"

**NOTE:** These axle ratings are to be used as a reference only. Refer to the vehicle's door plate for your specific application.

### PreSet Plus Service Kits and Components

PreSet Hubs	Rebuild Kit	Seal and Spacer Kit	Magnetic Fill Plug	Nut Assembly Kit*	Red Locking Snap Ring*
FF Flat	10081727	10081518	N/A	10036548	10026174
FF Keyway	10081727	10081518	N/A	10036549	10026174
FL	10081728	10081519	N/A	10036550	10031172
R-Drive	10081729	10081520	10033073	10036551	10026147
TN	10081730	10081521	10033073	10036552	10031029
TP	10081731	10081522	10033073	10036553	10030837

Rebuild kit includes seal, bearing spacer, inner cup and cone, outer cup and cone. Seal and spacer kit includes seal and bearing spacer. Nut assembly kit includes integrated spindle nut, locking washer, red locking snap ring and spiral nut retaining ring.

\*Not available for PreSet hub assemblies.

### ConMet Seals

Position	Spindle Type	Aftermarket Part Number
Steer	FF Spindle	10045885
	FL Spindle	10045883
Drive	R Spindle	10045887
Trailer	TP Spindle	10045889
	TN Spindle	10045888

## 6. PreSet Plus Wheel Hubs – Service Parts

### ConMet Seal Installation Tools

Axle Designation	Installation Tool Part Number	Minimum Diameter*	Maximum Diameter*
FF Steer	10084010	4.45"	4.65"
FL Steer	10084011	5.2"	5.4"
R-Drive	10084012	5.6"	5.85"
TN Trailer	10084013		
TP Trailer	10084013		

\*Required flat plate dimensions if you are not using a ConMet installation tool (minimum of 3/8", 9.5 mm thick).

### Approved PreSet Plus Aftermarket Bearings

Description	ConMet Number	Bearing Set Number
<b>FF Steer Axle</b>		
Inner Cup & Cone	10041905	Set 427
Outer Cup & Cone	10041906	Set 428
<b>FL Steer Axle</b>		
Inner Cup & Cone	10041925	Set 445
Outer Cup & Cone	10041926	Set 446
<b>R-Drive Axle</b>		
Inner Cup & Cone	10041915	Set 429
Outer Cup & Cone	10041916	Set 430
<b>TN Trailer Axle</b>		
Inner Cup & Cone	10041935	Set 431
Outer Cup & Cone	10041905	Set 427
<b>TP Trailer Axle</b>		
Inner Cup & Cone	10041945	Set 432
Outer Cup & Cone	10041945	Set 432

## 6. PreSet Plus Wheel Hubs – Service Parts

### ABS Rings for ConMet Hubs (for reference only)

Axle	Material	Type of Brake	Hub Casting Number	ABS Ring Part Number
FF Steer	Aluminum	Disc	10016331	10009780
			10018723	10009780
			10020207	10009780
		Drum	101945	10009780
			103110	10009780
			104112	10009780
	Iron	Disc	10011945	10009780
			10019965	10023558
		Drum	10005604	10009780
FL Steer	Aluminum	Drum	10012265	10019840
	Iron	Disc	10005561	107912
R-Drive	Aluminum	Disc	10016328	103705
		Drum	10001280	103705
	Iron	Drum	10001387	103705
			10018310	103705
			10018311	103705
TN Trailer	Aluminum	Drum	102035	105459
TP Trailer	Aluminum	Disc	10016620	10019896
		Drum	10001216	105459
	Iron	Drum	10025633	10023829

#### NOTE

If an ABS ring is not listed for a particular hub, contact ConMet Customer Service at 800-547-9473.

## 7. Lubrication

### DRIVE HUB LUBRICATION

Drive hubs can be lubricated by installing one quart of oil through the fill plug in the barrel of the hub.



#### CAUTION

The proper installation torque for the fill plug is 20-25 ft-lbs.

If no fill plug is present, the drive hub can be lubricated by lifting the opposite side of the axle 8" to allow the lubricant to run down the axle housing and into the hub assembly. Elevate the axle for two minutes to allow the lubricant time to fill the hub. Repeat the process for the opposite side of the vehicle. The rear axle carrier should be filled to the proper level to ensure adequate lubricant is available to fill the entire hub. Refill the carrier to the proper level after this procedure is completed.

### STEER AND TRAILER HUBS WITH OIL LUBRICANT

#### NOTE

Only use oil approved by the seal manufacturer (see approved list from the seal manufacturer or on [www.conmet.com](http://www.conmet.com)).

Some hubs are provided with a fill hole, located in the barrel and between the bearings for adding lubricant.

1. Fill the hub through the hubcap or the fill hole with oil. It may be necessary to add lubricant more than once to adequately fill the hub (see figure 86).

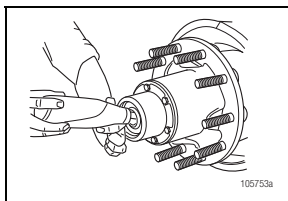

Filling the Hub with Oil  
FIGURE 86

2. Be certain the hubcap is properly filled to the "oil level" mark on the face of the cap (see figure 87). Allow the initial fill amount to settle for 10 minutes. Repeat the fill procedure until the oil is at the full line on the hubcap.

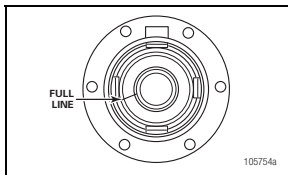

Fill to "Oil Level Line"  
FIGURE 87

3. Be sure to put the fill hole plug back into the hubcap and that the vent is working properly.

### TRAILER HUBS WITH SEMI-FLUID GREASE LUBRICANT



#### WARNING

Failure to fill and maintain the hub with the correct amount of semi-fluid grease may cause premature failure of the wheel hub system, bearing failure and possible loss of the wheel.

1. Remove the fill hole plug.
2. Loosen the hubcap bolts to allow air to escape while the hub is filling.

3. Fill the hub with the OEM recommended amount of room temperature (60°F minimum) semi-fluid grease through the fill hole in the hub (see figure 88).
  - For proper fill levels using semi-fluid grease, reference technical bulletin 10012569, Suggested Fill Volumes for Grade 00 Semi-Fluid Grease on ConMet's literature website at: <https://conmet.com/literature/>.

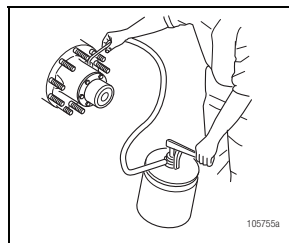

Filling Hub with Semi-Fluid Grease  
FIGURE 88

4. Retorque the hubcap bolts to 12-18 ft-lbs in a star pattern.
5. Reinstall and tighten the fill plug to 20-25 ft-lbs.

# 8. Brake and Wheel Installation

## Caliper Installation

Reinstall and adjust the brake pads and brake caliper according to the brake manufacturer's recommended instructions.

### Hub Pilot Wheel Mounting System

#### CAUTION

The brake drum must be fully seated on the drum pilot and against the hub face during and after installation of the wheel(s).

#### NOTE

If your shop practice requires the use of lubricant or anticorrosion material to the threads and/or the drum pilot area, avoid getting lubricant on the flat mating surfaces of the hub, drum, and wheels.

#### WARNING

Always snug the top nut first to fully seat the brake drum on the drum pilot and against the hub face. See the adjacent diagram for bolt tightening sequence, and tighten in order from 1 through 8 or 10, depending on the bolt pattern (see figure 89 and figure 90).

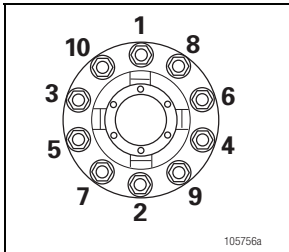

10 Stud Tightening Sequence  
FIGURE 89

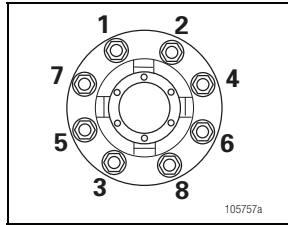

8 Stud Tightening Sequence  
FIGURE 90

1. Clean all mating surfaces on the hub, drum and nuts. Remove loose paint, scale, and any material building around the pilots of the drum, hub, and wheels. Be sure paint is fully cured on recently refurbished wheels.

#### CAUTION

Care should be taken to avoid damaging the hub or other components.

#### NOTE

If you plan to replace the brake drum (i.e., cast in place of CentriFuse®) or wheels (i.e., aluminum in place of steel), measure stud stand-out (see figure 91). In hub piloted mounting systems, the studs must be long enough for the threads to be exposed beyond the installed wheel nut. In the ball seat mounting system, the stud length beyond the brake drum should be from 1.31-1.44" as measured from the brake drum to the end of the stud. Call ConMet at 1-800-547-9473 for the correct stud part number for your application.

If you plan to replace the brake drum, verify the new drum has the same drum pilot diameter as the one that has been removed.

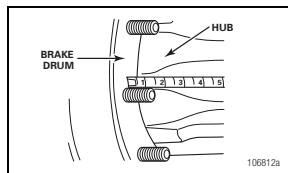

Measuring Stud Standout  
FIGURE 91

2. In environments where a corrosion inhibitor is beneficial, ConMet recommends the use of Corrosion Block, a product of Lear Chemical Research, (905) 564-0018. In severely corrosive environments, a light coat of Corrosion Block on the drum and wheel pilots has proven beneficial.
3. In addition to the above preparation, apply two drops of oil to a point between the nuts and nut flange washer and two drops to the last two or three threads at the end of each stud. Also, lightly lubricate the pilots on the hub to ease wheel installation and removal.

#### CAUTION

Do not get lubricant on the mounting face of the drum or wheel. Failure to clean lubricant from these surfaces may result in decreased clamping load.

4. Before installation of brake drums and wheels that utilize the hub piloted system, rotate the hub so one of the wheel pilot bosses is at the top (12 o'clock position) (see figure 92).

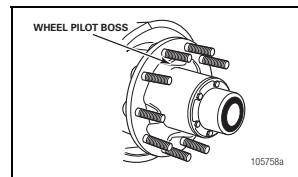

Rotating the Hub  
FIGURE 92

5. Position the brake drum over the hub, so it seats on the drum pilot and against the hub face.
6. Place the wheel(s) into position. One or more nuts can be started in order to hold wheel(s) and drum into position.

## 8. Brake and Wheel Installation (continued)

7. Snug the top nut first. Apply 50 ft-lbs torque to draw the brake drum up fully against the hub (see figure 93).

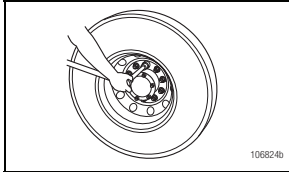

Reinstalling the Wheel  
FIGURE 93

8. Install the remaining wheel nuts and using the sequence as shown, torque all the nuts to 50 ft-lbs, then retorque to 450-500 ft-lbs (see figure 89 and figure 90). The last nut rotation must be with a calibrated torquing device.

### NOTE

When torquing wheel nuts, the temperature of all the wheel end components should be as close as possible to the midpoint of the expected operating range. For example, if the hub will operate between 0°F and 150°F, 75°F is a good temperature to torque at. Room temperature is often a close approximation of the midpoint temperature.

This recommendation is due to the differences in the coefficient of thermal expansion for the various materials in the wheel end including the hub, studs, wheel and brake drum. If the wheel nuts are torqued at temperatures well below the midpoint, when the system warms up, the studs may become overstressed. This could cause the studs to be permanently stretched, leading to nut loosening or damage to the wheel or hub. If the torque is applied at elevated temperatures, the system may become loose and lose clamp at lower temperatures, resulting in wheel damage and broken wheel studs. If the nuts must be torqued at extreme temperatures, the nut torque should be readjusted when the temperature is in the desired range. See also TMC RP250 "Effects of Extreme Temperatures on Wheel Torque and Clamp Load".

### NOTE

Use the appropriate nuts with the above technique to install the front and outer dual wheels. Follow your shop practice to locate the valve stems.

9. Inspect the brake and wheel installation by checking the seating of the wheel(s) and drum at the pilots, and by turning the wheel(s) and checking for any irregularity.

### ⚠ DANGER

Excessive or inadequate wheel nut torque can cause a failure of the wheel mounting system and a wheel separation resulting in severe personal injury or death and property damage. Always use a device that measures the torque being applied. After the first 50-100 miles, retorque all the nuts to 450-500 ft-lbs. Loosen the outer nuts to retorque the inner nuts.

### Ball Seat Wheel Mounting System

1. Clean all mating surfaces on the hub, drum, wheels and nuts. Remove loose paint, scale, and any material building around the pilots of the drum, hub, and wheels. Be sure paint is fully cured on recently refurbished wheels.

### NOTE

When dual wheels are mounted, the stud length beyond the brake drum (standout) should be from 1.31-1.44" as measured from the brake drum to the end of the stud (see figure 94).

When mounting dual aluminum wheels, use ALCOA inner cap nuts 5978R and 5978L or the equivalent. These nuts can also be used with longer studs up to 1.88" standout.

For special single aluminum wheel applications on drive and trailer hubs, use ALCOA single cap nuts 5995R and 5995L, or 5554R and 5554L or the equivalent, depending on the stud thread length (see Table A).

For single steel wheel applications, use BATCO 13-3013R and 13-3013L or the equivalent (see Table B).

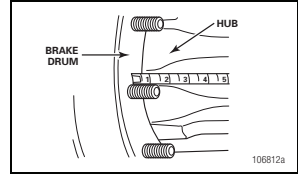

Stud Standout  
FIGURE 94

Table A: Single Aluminum Wheel Applications

Aluminum Wheels	ALCOA Cap Nut No.
3/4-16" Threaded Studs	5995R and 5995L or 5554R and 5554L, depending on stud length

Table B: Single Steel Wheel Applications

Steel Wheels	BATCO Cap Nut No.
3/4-16" Threaded Studs	13-3013R and 13-3013L

2. When installing the inner wheel and tire assembly, verify the inner nuts being used are suitable for the application: aluminum wheels, steel wheels, brake drum thickness, etc.

### ⚠ CAUTION

Inner cap nuts must be deep enough to ensure the stud will not bottom inside the nut and must be of a configuration approved by wheel manufacturer.

3. Rotate the hub to bring a drum pilot to the top (12 o'clock) position (see figure 95). Position the inner wheel and tire assembly over the studs against the drum.

## 8. Brake and Wheel Installation (continued)

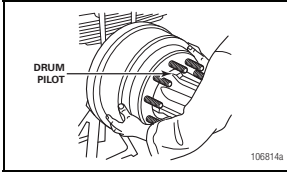

Rotating the Drum Pilot to 12 o'Clock  
FIGURE 95

4. Beginning in the 12 o'clock position, install the inner cap nuts by hand to ensure they are not cross-threaded. Do not tighten any nuts at this time.
5. Apply sufficient torque (about 50 ft-lbs) to the inner top cap nut to draw the brake drum up on the drum pilot and against the hub and seat the ball seat of the nut into the ball socket of the wheel (see figure 96).

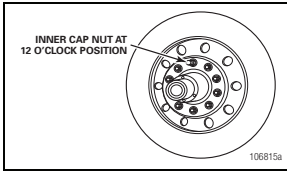

Tightening the Inner Cap Nuts  
FIGURE 96

6. To properly center the wheel, snug the remaining wheel nuts. Verify the drum is in place over the drum pilots (see figure 97).

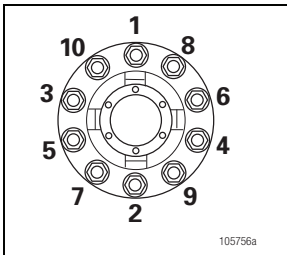

10 Stud Tightening Sequence  
FIGURE 97

7. Starting with the top nut first and using a staggered pattern, torque the inner wheel nuts in stages to 450-500 ft-lbs (see figure 98). The last nut rotation must be with a calibrated torquing device.

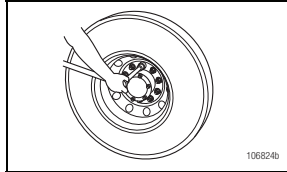

Torquing the Inner Wheel Nuts  
FIGURE 98

### NOTE

Use the appropriate nuts with the above technique to install the front and outer dual wheels. Follow your shop practice to locate the valve stems.

8. Install the outer wheel and nuts and tighten to 450-500 ft-lbs (see figure 99). The last nut rotation must be with a calibrated torque device.

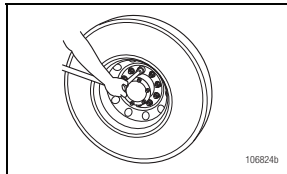

Torquing the Outer Wheel Nuts  
FIGURE 99

9. Inspect the brake and wheel installation by checking the seating of the wheel(s) and drum at the pilots and by turning the wheel(s) and check for any irregularity.

### ⚠ DANGER

Excessive or inadequate wheel nut torque can cause a failure of the wheel mounting system and a wheel separation resulting in severe personal injury or death and property damage. Always use a device that measures the torque being applied. After the first 50-100 miles, retorque all the nuts to 450-500 ft-lbs. Loosen the outer nuts to retorque the inner nuts.

# 9. Wheel Hub and Rotor

## WHEEL HUBS WITH ConMet DISC BRAKE ROTORS

This section applies to brake rotors designed and manufactured by ConMet for air disc brake applications. ConMet also manufactures hub assemblies equipped with brake rotors designed and manufactured by other brake companies. If your vehicle is equipped with a brake rotor other than a ConMet design, please refer to the vehicle or component manufacturer's published service information.

- Information relating to disc brake callipers, pads, or other vehicle-related systems is not included in this manual. Information regarding other brake-related components should be obtained from the vehicle or component manufacturer's published service information.

### Part Number Identification

Before you perform any service procedures, you must first determine if the vehicle is equipped with a disc brake rotor designed and manufactured by ConMet.

ConMet rotors can be identified by part number. The part numbers are cast into the rotor as shown in figure 100 and 100B, or stamped into the rotor as shown in figure 101.



Cast Rotor Part Number  
FIGURE 100

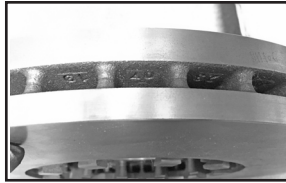

Cast in Part Numbers Between Cheeks  
FIGURE 100B



Stamped Rotor Part Number  
FIGURE 101

This part number can be used to find part specific service information. The latest disc brake rotor replacement instructions can be found on ConMet's literature website at <https://conmet.com/literature/> or scan the below QR code.

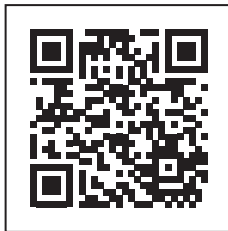

## Rotor Identification

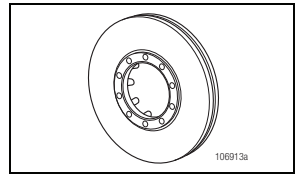

Flat Rotor  
FIGURE 102

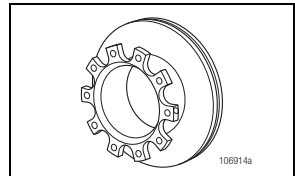

U-Shaped Rotor  
FIGURE 103

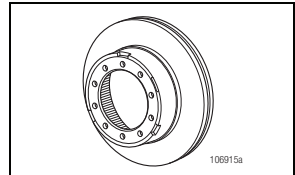

Hat Rotor  
FIGURE 104

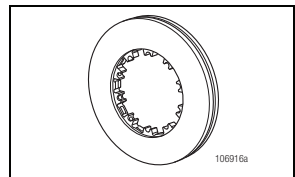

\*Bendix Splined Rotor – Refer to Bendix for splined rotor information  
FIGURE 105



# 10. Hub and Rotor Inspection

## HAZARD ALERT MESSAGES

Read and observe all hazard alert messages in this publication. They provide information that can help prevent serious personal injury, damage to components, or both.

### WARNING

To prevent serious eye injury, always wear safe eye protection when you perform vehicle maintenance or service.

Do not work under a vehicle supported only by jacks. Jacks can slip and fall over. Serious personal injury and damage to components can result.

Park the vehicle on a level surface. Block the wheels to prevent the vehicle from moving. Support the vehicle with safety stands.

### WARNING

Some brake linings contain asbestos fibers, a cancer and lung disease hazard. Some brake linings contain non-asbestos fibers, whose long-term effects to health are unknown. Use caution when handling both asbestos and non-asbestos materials.

## DISC BRAKE ROTOR INSPECTION

A disc brake component inspection should be a part of any pre-trip inspection and regularly-scheduled preventive maintenance program.

### WARNING

Follow all shop safety procedures before beginning vehicle inspection.

1. Lift and support the axles with safety stands. Refer to the vehicle manufacturer's recommended instructions.
2. Remove the wheels from the hub.

3. Rotate the hub and visually inspect both sides of the rotor for the out of service conditions detailed in this section. If any of these conditions are found, remove the hub and replace the rotor according to the instructions in this manual.

## Heat Checks

Heat checks are caused by the repeated heating and cooling of the braking surface. They appear as short, thin, radial interruptions in the braking surface. There may be numerous light and heavy heat checks on the braking surface. See figure 106 for examples of light heat checking and figure 107 for heavy heat checking.

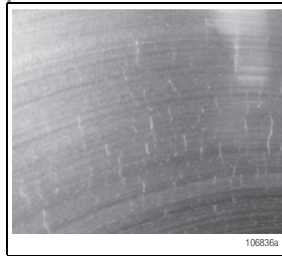

Light Heat Check  
FIGURE 106

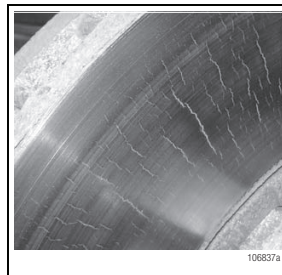

Heavy Heat Check  
FIGURE 107

## Cracks

Heat checks may wear away or they may eventually become braking surface cracks. Rotors should be replaced if cracks become over 0.060" wide or over 0.060" deep and extend over 75% of the braking surface in the radial direction.

Rotor cracking can be the result of many potential brake system issues resulting in excessive operating temperatures, or thermal overload of the rotor. The brake system should be inspected for potential contributing factors, such as air system contamination/release issues, sticking or over-adjusted calipers, ABS/ESC issues, vehicle brake imbalance, improper actuator, improperly specified friction or spring can function, or poor quality friction.

Cracked rotors may be caused by mishandling, brake balance issues, wear beyond the minimum allowable thickness, or driver abuse. If a crack extends through a section of the rotor, the rotor should be replaced. If a crack is found on the mounting section of the rotor, the rotor should be replaced. Figure 108 shows a cracked rotor that should be replaced. The crack in figure 109 is acceptable to run, but the rotor should be inspected on a regular basis to ensure that the crack has not progressed.



Unacceptable Crack  
FIGURE 108

# 10. Hub and Rotor Inspection (continued)

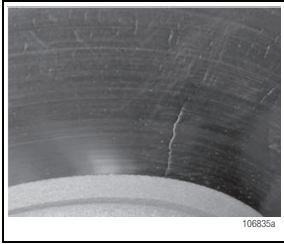

Acceptable Crack  
FIGURE 109

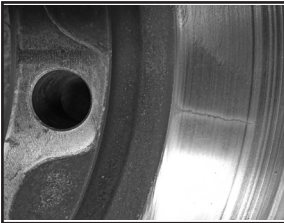

Crack Originating From Flange  
FIGURE 110

Rotors with cracks initiating from, or extending into the flange should be replaced immediately. Causes of flange cracking include towing the truck without caging the brakes, uneven hub interface, stuck brake calipers, rotor mismatch to hub, or air system leaks.

## Deep Grooves or Scoring

Grooves or scoring may be caused by contaminants trapped between the lining and the rotors, worn out linings, poor quality friction, or the lining plate contacting the rotor. Grooves or scoring on the brake rotor are acceptable if they are less than 0.060" deep. If the rotor thickness, when measured across a groove, is less than the minimum allowable thickness for the rotor, the rotor should be replaced. See figure 111 for example of grooves on the braking surface of the rotor. Adding pad and rotor shields may correct grooving. If the vehicle is

already equipped with pad and rotor shields, removing them may correct this condition.

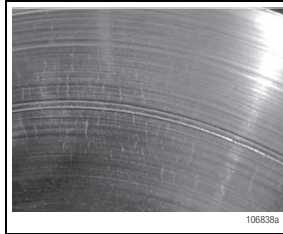

Grooves on Brake Surface  
FIGURE 111

## Blue Marks or Bands

If the rotor has become extremely hot, the braking surface may exhibit blue marks or bands. See figure 112 for examples of these marks. This condition may be caused by continued hard stops, improper brake balance, improper brake caliper clearance, operation, or adjustment. The cause of overheating should be determined and corrected. It is not necessary to replace the rotor as long as it meets the proper dimensional specifications for runout and thickness.

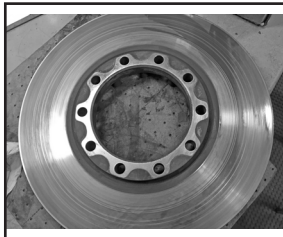

Blue Marks  
FIGURE 112

## Polished Rotors

A polished rotor will have a mirror-like finish on the braking surface (see figure 113). This condition

may be caused by improper lining friction rating, lightly dragging brakes, or a rotor resurfaced to too fine of a microfinish. To correct this condition, sand the braking surface on the rotor and the brake pads with 80 grit emery cloth. If the condition returns, verify that the linings on the brake pads have the correct friction rating for the application.

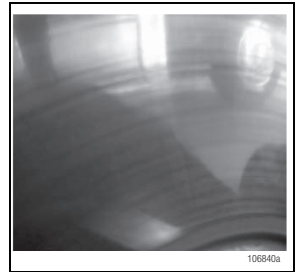

Polished Rotor  
FIGURE 113

## Martensite

Rotors subjected to extremely high heat followed by rapid cooling can form martensite. Martensite appears as a dark black, raised plate-like surface on the rotor, and is hard and brittle. (see figure 114). The high temperatures cause a structural change to the rotor material. This condition can make the rotor more susceptible to cracking.

Rotors with this condition should be replaced. Check the brake linings for uneven wear and replace as necessary. After the rotor has been replaced, and the hub and rotor reinstalled onto the axle, the brake system should be checked for proper caliper actuation and proper brake balance.

# 10. Hub and Rotor Inspection (continued)

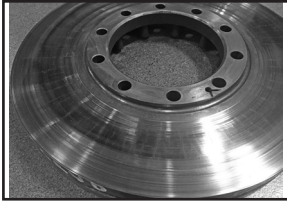

Martensite Bands on Rotor  
FIGURE 114

## Grease/Oil-Stained Rotors

Brake rotors that have discolorations due to grease or oil on the brake surface should be removed from the vehicle and cleaned to remove the grease or oil (see figure 115). The brake pads should be inspected and replaced if they are found to be soaked with grease or oil. The source of the grease or oil should be identified and repaired.



Grease/Oil-Stained Rotor  
FIGURE 115

## Lining Transfer

High operating temperatures or improper lining material can result in excessive or uneven brake lining transfer onto the braking surface of the brake rotor (see figure 116). This may start as a spotty thin layer of lining material that has become welded to the brake rotor and may end up covering most of the braking surface. This condition will accelerate lining wear.

Brake imbalance, brake system malfunction, improperly specified friction material, or poor quality friction material can cause this condition. The cause of the high brake operating temperature should be identified and corrected before the vehicle is put back into service.

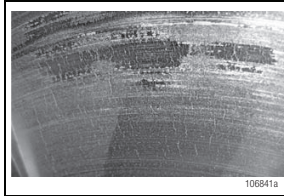

Lining Transfer  
FIGURE 116

Causes of high brake operating temperature can include brake imbalance or brake system malfunction. The lining manufacturer should also be consulted.

## Clogged or Restricted Vent Holes

Off-road and severe-duty applications may result in vent holes in the rotor becoming blocked by an accumulation of debris such as rocks or dirt (see figure 117). The vent holes should be cleaned as required to allow air flow and proper cooling of the brake rotor.



Clogged Vent Holes  
FIGURE 117

## Rotor Runout

Measuring the runout of a rotor that is still assembled on the vehicle is the best way to determine if the rotors have excessive runout or "wobble". Do not attempt to determine if a rotor has excessive runout by measuring the hub/rotor assembly which it is not assembled on a vehicle.

Lateral runout, or wobble, on the rotor braking surface should not exceed 0.020" in one full revolution of the rotor. The measurement should be taken with a dial indicator at the center of the rotor braking surface. See figure 118 for proper runout measurement set up.

If the rotor runout is greater than 0.020", verify that the wheel bearings are not excessively loose. See page 3, steps 7 and 8. If wheel bearings are loose, service wheel end per instructions based on hub configuration. If runout is still greater than 0.020", the rotor should be replaced.

Radial runout on the outside diameter of the braking surface should not exceed 0.035" when checked with a dial indicator (see figure 119). If the runout exceeds 0.035", the rotor should be replaced. Runout should be checked with the hub on the axle.

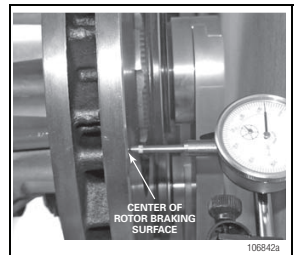

Lateral Runout  
FIGURE 118

## 10. Hub and Rotor Inspection (continued)

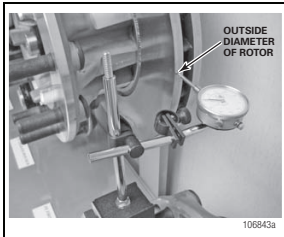

Radial Runout  
FIGURE 119



Wear Line Indicator  
FIGURE 120

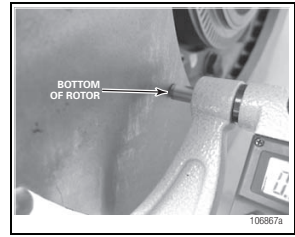

Bottom of Rotor  
FIGURE 123

### Rotor Thickness

A worn brake rotor will often have a defined lip on the outer diameter of the rotor that can be observed during inspection and/or felt when running a finger across it. Many ConMet rotors have a wear indicator on the outer diameter to help with determining if the rotor is close to the wear limit (see Figure 120). If excessive wear is suspected, the thickness of the rotor should be measured.

Using a micrometer, measure the rotor thickness at the locations of maximum wear. If the wear is uniform, measure the rotor at 3 locations radially as shown in figures 121, 122, and 123. All ConMet rotors have the minimum thickness cast into or stamped on the rotor near other identifying lettering. If this lettering cannot be located, use the Brake Rotor Minimum Thickness table on page 50.

If any thickness measurement exceeds the minimum, replace the rotor.

Rotor wear is a normal condition. However, if the rotor is wearing excessively fast or unevenly, the cause could be foreign debris, too tight of pad running clearance, or poor quality brake linings.

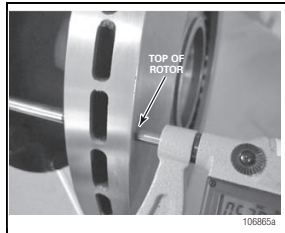

Top of Rotor  
FIGURE 121

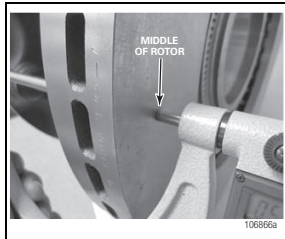

Middle of Rotor  
FIGURE 122

### Rotor Resurfacing

ConMet does not recommend resurfacing disc brake rotors. However, if rotor resurfacing is necessary, be sure that at least 0.060" of material is left above the rotor minimum thickness specification to allow for wear before the minimum allowable rotor thickness is reached.

For example, for a rotor with an original thickness of 1.77" and a minimum wear thickness of 1.46", the minimum thickness after resurfacing should be 1.52". In addition, the braking surface finish must not exceed 150 RMS, and the TIR must not exceed 0.020" when assembled on vehicle.

# 11. Hub and Rotor Removal and Disc Replacement

## HAZARD ALERT MESSAGES

Read and observe all hazard alert messages in this publication. They provide information that can help prevent serious personal injury, damage to components, or both.

### WARNING

Do not work under a vehicle supported only by jacks. Jacks can slip and fall over. Serious personal injury and damage to components can result.

Park the vehicle on a level surface. Block the wheels to prevent the vehicle from moving.

To prevent serious eye injury, always wear safe eye protection when you perform vehicle maintenance or service.

## HUB AND ROTOR REMOVAL

1. Lift the axle and support it with safety stands. Refer to the vehicle manufacturer's recommended instructions.
2. Remove the tires and wheels.
3. Remove the hubcap or drive axle. Refer to the manufacturer's recommended instructions.
4. Follow the brake manufacturer's instructions to remove the brake caliper and brake pads from the axle mounting point.

### WARNING

Do not loosen the axle spindle nuts by either striking them directly with a hammer, or striking a drift or chisel placed against them. Damage to the parts will occur causing possible loss of axle wheel-end components and serious personal injury.

5. Remove the spindle nut assembly.

### NOTE

Refer to Conventional, PreSet and PreSet Plus hub removal procedures in this manual for specific spindle nut removal instructions.

6. Slide the hub and rotor assembly off the spindle. Be careful not to damage the outer bearing.
7. Remove the bolts that secure the rotor to the hub. Be careful not to damage the ABS tone ring when the rotor is removed.
8. Remove the seal from the hub.
9. Clean the bearing cups and cones, bearing spacer, grease cavity, and seal bore of the hub.
10. Inspect all components for signs of wear or damage. Replace components as necessary.
11. Clean the spindle. It may be necessary to remove the inner portion of the seal from the spindle. If necessary, use emery cloth to remove rust and foreign material from the seal journal on the spindle.
12. Clean the rotor mounting area of the hub.

## DISC BRAKE ROTOR REPLACEMENT

### WARNING

Do not hit steel parts with a steel hammer. Pieces of a part can break off. Serious personal injury and damage to components can result. Use a brass or synthetic mallet for assembly and disassembly procedures.

Determine your rotor part number per Rotor Part Identification instructions on page 44. The latest disc brake rotor replacement instructions can be found on ConMet's literature website at <https://conmet.com/literature/> or scan the below QR code:

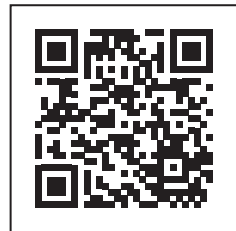

# Wheel Hub and Rotor – Service Parts List

## Brake Rotor Minimum Thickness

Rotor Part Number	Minimum Thickness	Service Kit Part Number	Notes
10019996 Medium Duty Flat Rotor	1.42" (36.1 mm)	10020611	
10016195 Flat Rotor	1.46" (37.0 mm)	10085621	Rotor 10016195 is obsolete and has been replaced by rotor 10084701
10083615 Flat Rotor	1.46" (37.0 mm)	10085621	Rotor 10083615 is obsolete and has been replaced by rotor 10084701
10084701 Flat Rotor	1.46" (37.0mm)	10085621	
10009970 Flat Rotor	1.46" (37.0mm)	N/A	Rotor 10009970 is obsolete and without replacement
10034621 Flat Rotor	1.46" (37.0 mm)	10087663 (FF Steer)	Rotor 10034621 is obsolete, for FF Steer application replace with rotor 10087486
		10087664 (R Driver)	Rotor 10034621 is obsolete, for R Drive application replace with rotor 10087485
10086208 Flat Rotor	1.46" (37.0mm)	10087663 (FF Steer)	Rotor 10034621 is obsolete, for FF Steer application replace with rotor 10087486
10086207 Flat Rotor	1.46" (37.0mm)	10087664 (R Driver)	Rotor 10034621 is obsolete, for R Drive application replace with rotor 10087485
10087486 Flat Rotor	1.46" (37.0mm)	10087663 (FF Steer)	
10087485 Flat Rotor	1.46" (37.0mm)	10087664 (R Driver)	
10037760 Flat Rotor	1.46" (37.0 mm)	10041215 (FF Steer)	
		10041217 (R-Drive)	
10083733 Flat Rotor	1.46" (37.0mm)	10083923 (FF Steer)	
		10083924 (R-Drive)	
10003830 Hat-Shaped Rotor	1.32" (33.5 mm)	10030921	
10020109 U-Shaped Rotor	1.46" (37.0 mm)	10020682	
10041006 U-Shaped Rotor	1.46" (37.0 mm)	10082074	
10080753 U-Shaped Rotor	1.46" (37.0 mm)	10082181	
10082120 U-Shaped Rotor	1.46" (37.0mm)	10086065	

**NOTE:** All parts must be ordered as a kit.

# Wheel Torque Specifications

## Wheel End Torque Specifications

Item	Measurement	Torque (ft-lbs)	Notes
Ball Seat Wheel Nut	3/4 – 16	450 - 500	Always tighten the top nut first or pilot damage may result. Do not lubricate the faces of the hub, drum, wheel, or on the ball seats of the wheel nuts. The last nut rotation should be with a calibrated torque device.
	1-1/8 – 16	450 - 500	
Hub Pilot Wheel Nut	22 mm x 1.5 mm	450 - 500	Always tighten the top nut first or pilot damage may result. Apply two drops of oil between the nut and nut flange, and two or three drops to the outermost second or third thread of the wheel studs. Lightly lubricate the wheel pilots on the hub. The last nut rotation should be with a calibrated torque device.
Drive, Studs, Installation Torque	3/4 – 16	55 - 75	Torque value is for drive axle stud installation only. For drive axle flange nuts, see axle manufacturer's recommendations for proper torque.  *For Aluminum hubs, target 50 ft-lb
	5/8 – 18*	55 - 75	
	9/16 – 18	40 - 60	
	1/2 – 20	40 - 60	
Hub Cap	5/16 – 18	12 - 18	Minimum SAE Grade 5 fasteners, flat washers only.
Oil Fill Plug	1/4 NPT	20 - 25	-
	3/8 NPT	20 - 25	-
	9/16 – 18	20 - 25	O-Ring Style
Bolt-On ABS Ring Screw	8 – 32	18 - 22 in-lbs	
	1/4 – 20	125 - 135 in-lbs	
Disc Brake Rotor Screw	M8 x 1.25	18 - 22	
	M16 x 1.5	190 - 210	
	1/2 – 20	100 - 120	
	9/16 – 12	130 - 150	
	5/8 – 11	190 - 210	
	5/8 – 18	210 - 230	
Disc Brake Rotor Nut (Stud in Hub)	5/8 – 18	190 - 210	
Drive Axle Flange Nuts			See axle manufacturer's recommendations for proper drive axle nut torque.
2-Piece Nut on PreSet (FF, FL, R, TN, TP, L)		300 Inner 200 Outer	300 minimum. Advance to nearest lock. Set wrench at 200 for outer nut. <b>DO NOT BACK OFF.</b>
2-Piece Nut on PreSet (FC-Medium Duty Steer Hub)		150 Inner 100 Outer	150 minimum. Advance to nearest lock. Set wrench at 100 for outer nut. <b>DO NOT BACK OFF.</b>
1-Piece Nut on PreSet (FF, FL, R, TN, TP, L)		300	300 minimum. Advance to nearest lock. <b>DO NOT BACK OFF.</b>
1-Piece Nut on PreSet (FC-Medium Duty Steer Hub)		150	150 minimum. Advance to nearest lock. <b>DO NOT BACK OFF.</b>
PreSet Plus Drive and Trailer Nut		500	Set wrench at 500. <b>DO NOT BACK OFF.</b>
PreSet Plus Steer Nut		300	Set wrench at 300. <b>DO NOT BACK OFF.</b>

# Notes

A large, empty rectangular box with a thin black border, occupying most of the page. It is intended for the user to write their notes.

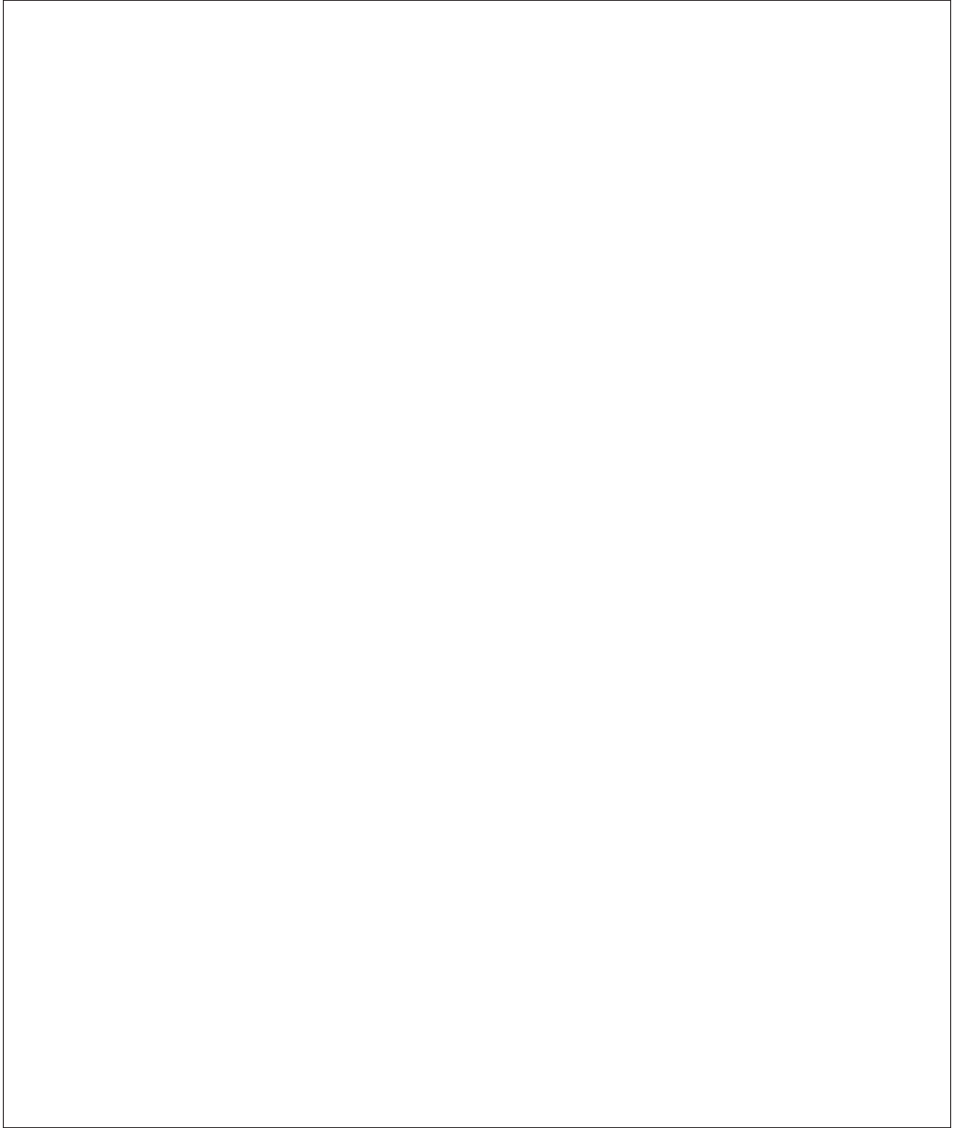

# Notes

A large, empty rectangular box with a thin black border, occupying most of the page. It is intended for the user to write their notes.

# Notes

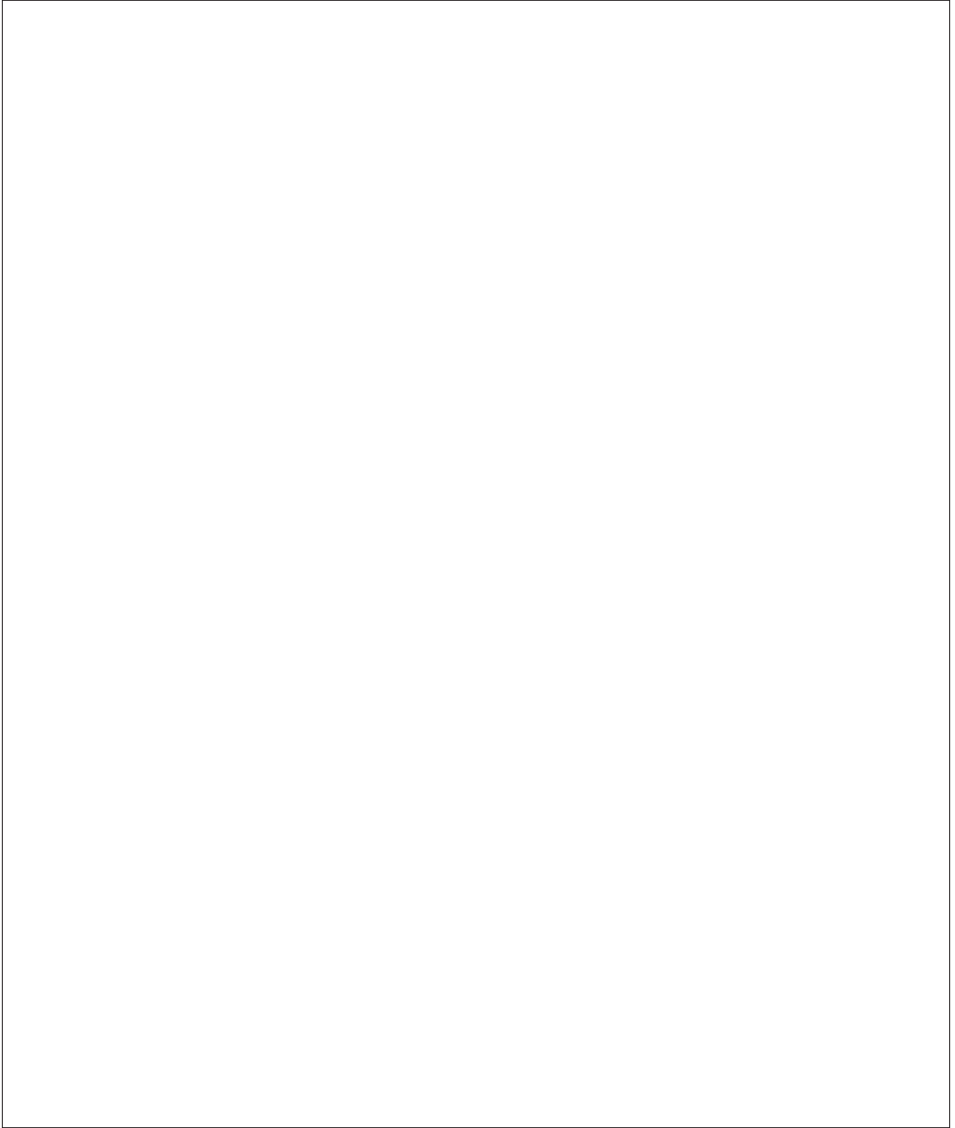
A large, empty rectangular box with a thin black border, occupying most of the page. It is intended for the user to write their notes.

# Notes

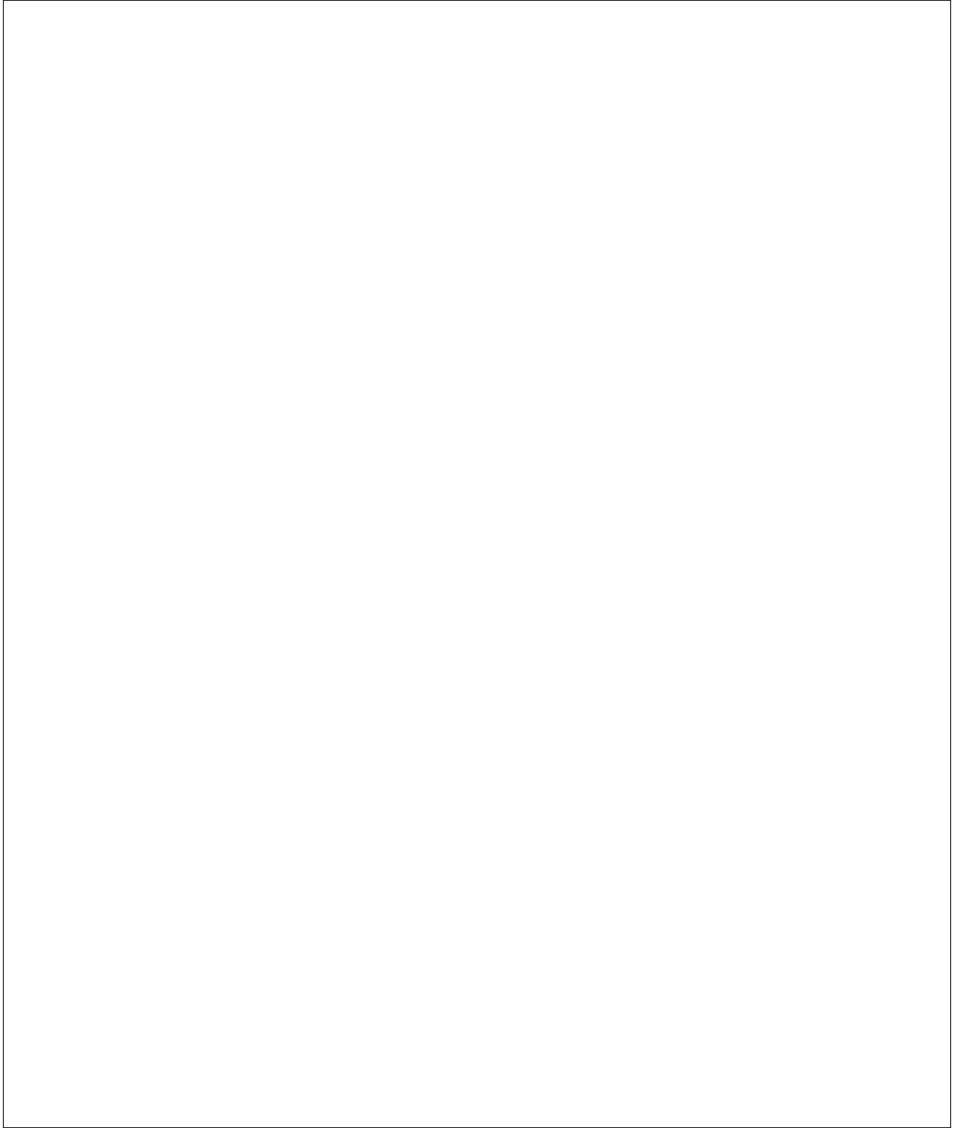
A large, empty rectangular box with a thin black border, occupying most of the page. It is intended for the user to write their notes.

# Notes



Follow us on:

