



**VELUX®**

# 2024 Reference Guide

Residential Skylights and Sun Tunnel® Skylights

**Effective February 5, 2024**

All retail prices are not valid in Alaska, Hawaii, or Mexico due to additional freight cost.

# Contents

<b>8</b>	<b>Unit Skylights</b>	
	VSS/VSE Deck-Mounted Solar/Electric Venting	8
	VCS/VCE Curb-Mounted Solar/Electric Venting	10
	EVMS Self-Flashed Solar Venting	12
	VS Deck-Mounted Manual Venting	14
	VCM Curb-Mounted Manual Venting	16
	EV Self-Flashed Manual Venting	18
	FS Deck-Mounted Fixed	20
	FCM Curb-Mounted Fixed	22
	FCM Curb-Mounted Fixed Custom Sizes	24
	QPF Self-Flashed Fixed	26
	EF Self-Flashed Fixed	28
	GSM Curb-Mounted Fixed	30
<b>32</b>	<b>Sun Tunnel® Skylights</b>	
	Rigid/Flex Tube	32
	Wildfire/Impact Glass	34
<b>36</b>	<b>Flat Roof Skylights</b>	
	FXG Curb-Mounted Domed	36
	CXP Domed Polycarbonate Hatch	36
	CFU CurveTech Glass	38
<b>40</b>	<b>Flashing and Accessories</b>	
	EKL/EKW Combi Flashing	40
	Skylight Shades	42
	Skylight Accessories	44
	Sun Tunnel® Accessories	46
<b>48</b>	<b>Roof Windows</b>	
	GPU Top-Hinged	48
	GXU Roof Access	50
	GDL Balcony	52
	GGU Center-Pivot	54
<b>56</b>	<b>Architectural Skylights</b>	
	Custom Skylight Systems: Pinnacle, Classic, Low Profile	56
	VMS VELUX Modular Skylights	58



# VELUX Online Dealer Support

## Dealer Support Center

The VELUX Dealer Support Center has everything you need to complete your VELUX orders. Through our online dealer support page, you can:

- Check warehouse inventory
- Create quick quotes
- Track your orders
- Locate product data
- And so much more!

Use your phone's camera to scan the QR code below to access the Dealer Support Center today.



DEALER SUPPORT CENTER  
veluxsolutions.com/dealersupport

# How to Order Your Product



Online - Dealer Extranet<sup>1</sup>  
dealerextranet3.veluxusa.com

Hours of Operation  
24 hours a day, 7 days a week



Email  
ordersusa@velux.com



Call Residential  
1-800-888-3589

Hours of Operation (ET)  
(Mon - Fri) 7:30 a.m. - 8 p.m.  
(Sat) 9 a.m. - 5 p.m.



Call/Email Commercial  
1-800-888-3589  
commercialteam@velux.com

Hours of Operation (ET)  
(Mon - Fri) 7:30 a.m. - 8 p.m.  
(Sat) 9 a.m. - 5 p.m.

<sup>1</sup> Dealer Extranet allows a dealer to order products and perform routine inquiries 24/7 using real-time pricing and inventory availability.

# Plan for Delivery Time

- S** In-stock at regional warehouses  
**Allow 2 - 4 bus. days**
- A** In-stock at Sparks, NV region  
**Allow 2 - 3 bus. days; other areas call for availability**
- B** At Sparks, NV and White Marsh, MD  
**Allow 2 - 5 bus. days**
- C** In-stock at Greenwood, SC and Kent, WA regions  
**Allow 2 - 5 bus. days**
- T** Trans-shipped from central warehouse  
**Allow 7 - 10 bus. days**
- F** In-stock at Greenwood, SC and Sparks, NV regions  
**Allow 2 - 4 bus. days; other areas allow 7 - 10 bus. days**
- G** In-stock at Greenwood, SC, Aurora, IL, and Sparks, NV  
**Allow 2 - 3 bus. days; other areas allow 5 - 7 bus. days**
- R** Not stocked; Manufactured on demand  
**Allow approximately 10 bus. days**
- D** Not stocked; Manufactured on demand  
**Allow approximately 26 bus. days**
- N** Not stocked; Manufactured on demand  
**Allow approximately 37 bus. days**
- L** Not Stocked; Manufactured on demand  
**Allow approximately 50 bus. days**

Please note: large orders may be subject to additional ship times

# Order Code Examples

$$\begin{array}{l}
 \text{no shades} \quad \frac{\text{VSS}}{\text{product}} + \frac{\text{C01}}{\text{size}} + \frac{\text{2004}}{\text{code}} \\
 \text{with shades} \quad \frac{\text{VSS}}{\text{product}} + \frac{\text{C01}}{\text{size}} + \frac{\text{2004}}{\text{code}} + \frac{\text{CS00}}{\text{shade}}
 \end{array}$$

# VELUX Weathertight Skylights

The VELUX deck and curb mounted product family is made with high-quality, weathertight materials, and carries a 10-year installation warranty plus 20 years on glass, 10 years on product, and 5 years on shades and controls.

## VELUX Patented Deck Seal Technology

Three layers of water protection for deck mounted skylights:

- 1 Pre-Attached Seal**  
Pre-attached deck seal (deck-mounted) or gasket (curb-mounted) provides a tight seal for leak-proof installation.
- 2 Adhesive Underlayment**  
Adhesive underlayment for secondary water protection against the harshest weather conditions.
- 3 Engineered Flashing**  
Engineered flashing for easy installation and primary water protection.



# The Glass in Our Skylights

## VELUX Standard Glass

Most VELUX skylights feature our Standard Safety Glass, a laminated glass that is safe and compliant with all building codes for out-of-reach applications. VELUX skylight glass is also double-paned with an argon fill to help reduce up to 25% more unwanted outside noise than standard double pane glass and up to 50% more than plastic skylights.

### Standard Safety Glass (xx04)

This laminated glass is standard on all **FS, VS, VSS, VSE, VCS, VCE, FCM, VCM, QPF, EV, EF, EVMS** models.

### Tempered Glass (xx05)

Built with an additional degree of hardness for added safety. Available with **FCM, VCM, QPF** only.

### Impact Glass (xx06)

Our toughest glass, resistant to penetration from wind-borne debris.

### White Laminated Glass (xx08)

White coating diffuses 100% of light flowing to the space below.

### Snowload Glass (xx10)

Reinforced glass to withstand added weight from accumulated snow.

# What is a Roof Pitch?

The roof pitch is defined as the angle of the roof, and it's calculated by the number of inches it rises vertically for every 12" it extends horizontally. This angle is measured by placing a pitch-gauge directly on the roof and taking an accurate reading.

This calculation is important because each VELUX skylight and flashing kit is engineered with specific pitch requirements that match the roof's slope in order to effectively drain water off the skylight.



0° - 15° 0:12 - 3:12	0° - 60° 0:12 - 20:12	1° - 60° 1/4:12 - 20:12	10° - 60° 2:12 - 20:12	14° - 60° 3:12 - 20:12	14° - 85° 3:12 - 137:12	15° - 55° 3:12 - 17:12	15° - 85° 3:12 - 137:12	15° - 90° 3:12 - 90°	35° - 53° 8.4:12 - 15:12
CFU	VCS	GSM	QPF	TLR	VSS	GPU	GXU	GGU	GDL
CXP	VCM		TZRL	TMR	VSE				
	VCE		TZRQ	TGR	VS				
	FCM			TMF	FS				
	TZR			TGF	EVMS				
	TCR				EV				
	FXG				EF				

# The new VELUX Touch



# VELUX ACTIVE



## Simple control of all VELUX skylights and shades with one remote.

We believe your customers should have an easier experience creating the perfect home environment with their VELUX skylights and shades. Now, with VELUX Touch, they only need to reach for one remote to take control of their skylights and shades. It is all about indoor comfort at your customer's fingertips.

- Remote operation inside the room
- Operation of multiple products
- Group products
- Ventilation timer
- Lock home option (close all skylights)
- Preset shade and skylight positions

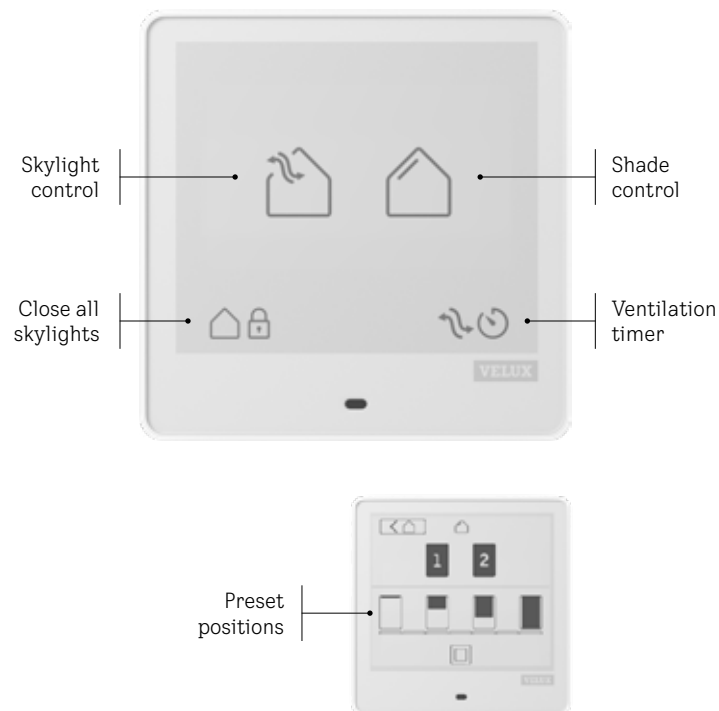

VELUX Touch Remote Control	Delivery
KLR 300 WW	S

## Smart sensor-based operation of VELUX skylights and shades.

VELUX ACTIVE uses the Climate Sensor to monitor the indoor air quality, then automatically opens or closes skylights and shades based on conditions and homeowner's preferences. The system is connected to the home's Wi-Fi through the Internet Gateway so the customer can control skylights and shades, even if they're away from home, through the app on their phone.

- Remote operation from anywhere
- Operation of multiple grouped products
- Compatible with Apple HomeKit® and Google Assistant™
- Ventilation timer
- Scheduling to personal preferences
- Voice control
- Live sensor-based data and automation
- Use of weather data

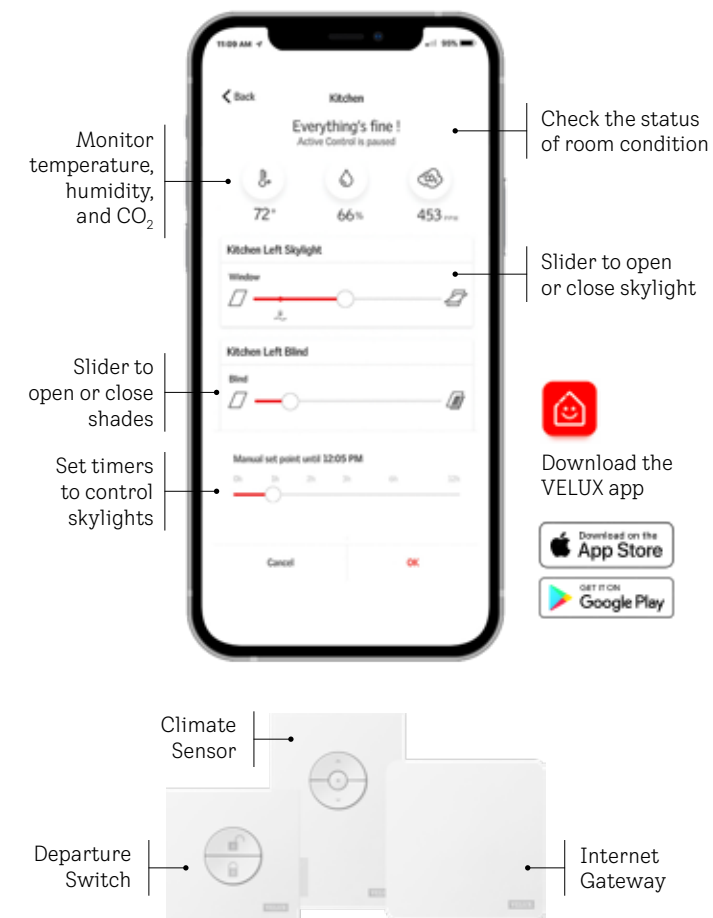

VELUX ACTIVE with NETATMO	Delivery
KIX 300 US	S

# Unit Skylights

## Deck-Mounted VSS/VSE



**VSS Solar Fresh Air**

**VSE Electric Fresh Air**

Remote and insect screen included with VSS and VSE skylight

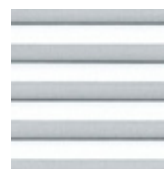

### Add a Solar-Powered Pre-Installed Shade

Room-Darkening, Double-Pleated White  
**CS00**

See page 43 for special order shade options.



### The New VELUX Touch

Control all of your skylights and shades from one touch screen remote control.

#### KLR 300 WW

See page 6 for more information.



### VELUX App Control

Control your VELUX skylights and shades anytime, anywhere with your smartphone or smart home device.

#### KIG 300 US



### VELUX ACTIVE

Add smart home automation to your fresh air skylights and control all products with your phone.

#### KIX 300 US











See page 7 for more information.

Pre-Installed shades not available on copper cladding or stain grade wood models.

All base models are available to have pre-installed shades, however, some optional skylight models may not be available. VELUX Customer Service will confirm availability.



HGTV  
**URBAN OASIS**  
PROUD SPONSOR  
— 2023 —

Standard Sizes (W-in. x H-in.)	C01	C04	C06	C08	M02 <sup>1</sup>	M04	M06	M08	S01	S06
 14° - 85° 3:12 - 137:12										
Rough Opening	21 x 26 <sup>7</sup> / <sub>8</sub>	21 x 37 <sup>7</sup> / <sub>8</sub>	21 x 45 <sup>3</sup> / <sub>4</sub>	21 x 54 <sup>7</sup> / <sub>16</sub>	30 <sup>1</sup> / <sub>16</sub> x 30	30 <sup>1</sup> / <sub>16</sub> x 37 <sup>7</sup> / <sub>8</sub>	30 <sup>1</sup> / <sub>16</sub> x 45 <sup>3</sup> / <sub>4</sub>	30 <sup>1</sup> / <sub>16</sub> x 54 <sup>7</sup> / <sub>16</sub>	44 <sup>1</sup> / <sub>4</sub> x 26 <sup>7</sup> / <sub>8</sub>	44 <sup>1</sup> / <sub>4</sub> x 45 <sup>3</sup> / <sub>4</sub>
Outside Frame	21 <sup>1</sup> / <sub>2</sub> x 27 <sup>3</sup> / <sub>8</sub>	21 <sup>1</sup> / <sub>2</sub> x 38 <sup>3</sup> / <sub>8</sub>	21 <sup>1</sup> / <sub>2</sub> x 46 <sup>1</sup> / <sub>4</sub>	21 <sup>1</sup> / <sub>2</sub> x 54 <sup>15</sup> / <sub>16</sub>	30 <sup>9</sup> / <sub>16</sub> x 30 <sup>1</sup> / <sub>2</sub>	30 <sup>9</sup> / <sub>16</sub> x 38 <sup>3</sup> / <sub>8</sub>	30 <sup>9</sup> / <sub>16</sub> x 46 <sup>1</sup> / <sub>4</sub>	30 <sup>9</sup> / <sub>16</sub> x 54 <sup>15</sup> / <sub>16</sub>	44 <sup>3</sup> / <sub>4</sub> x 27 <sup>3</sup> / <sub>8</sub>	44 <sup>3</sup> / <sub>4</sub> x 46 <sup>1</sup> / <sub>4</sub>

Base Model	C01	C04	C06	C08	M02 <sup>1</sup>	M04	M06	M08	S01	S06
Laminated LowE <sup>3</sup> Glass	-	-	-	-	-	-	-	-	-	-
Code 2004   Delivery S	-	-	-	-	-	-	-	-	-	-

**Optional Models<sup>2</sup>** Add price to base model; any size. Applies to standard sizes only.

Impact Glass Code 2006   Delivery N	Copper Cladding VSE only excluding M02 Code 2104   Delivery D	Snowload Glass Code 2010   Delivery A	Stain Grade Wood Interior VSS only Code 0004   Delivery D
--	---	--	---

**Flashing** Adhesive underlayment included. VELUX flashing required for the 10-Year Installation Warranty.

	C01	C04	C06	C08	M02 <sup>1</sup>	M04	M06	M08	S01	S06
Step Asphalt Shingles/Wood Shake/Slate 1/2 in. max thickness Code EDL   Delivery S	-	-	-	-	-	-	-	-	-	-
Copper Step <sup>3</sup> Asphalt Shingles/Wood Shakes/Slate 1/2 in. max thickness Code EDL COPPER   Delivery D	-	-	-	-	-	-	-	-	-	-
High Profile <sup>3</sup> Tile - over 3/4 in. thickness Code EDW   Delivery S	-	-	-	-	-	-	-	-	-	-
Metal Roof Code EDM   Delivery S	-	-	-	-	-	-	-	-	-	-
Biepak <sup>4</sup> Counter Flashing for Deck-Mounted Code ECB   Delivery S	-	-	-	-	-	-	-	-	-	-

<sup>1</sup> VSS only. <sup>2</sup> Lead time/size availability may vary from base model. <sup>3</sup> VSE only. <sup>4</sup> Adhesive underlayment not included.

Order Code Example  $\frac{\text{VSS}}{\text{product}} + \frac{\text{C06}}{\text{size}} + \frac{\text{2004}}{\text{code}} + \frac{\text{CS00W}}{\text{shade}}$

# Unit Skylights

## Curb-Mounted VCS/VCE



**VCS** Solar  
Fresh Air

**VCE** Electric  
Fresh Air

Remote and insect screen included with VCS and VCE skylight

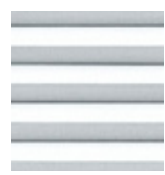

### Add a Solar-Powered Pre-Installed Shade

Room-Darkening, Double-Pleated White  
**CS00**

See page 43 for special order shade options.



### The New VELUX Touch

Control all of your skylights and shades from one touch screen remote control.

#### KLR 300 WW

See page 6 for more information.



### VELUX App Control

Control your VELUX skylights and shades anytime, anywhere with your smartphone or smart home device.

#### KIG 300 US



### VELUX ACTIVE

Add smart home automation to your fresh air skylights and control all products with your phone.

#### KIX 300 US

See page 7 for more information.

All base models are available to have pre-installed shades, however, some optional skylight models may not be available. VELUX Customer Service will confirm availability.



Standard Sizes (W-in. x H-in.)	2222	2234	2246	3030	3046	3434	3737 <sup>1</sup>	4622 <sup>1</sup>	4630 <sup>1</sup>	4646
Inside Curb	22 1/2 x 22 1/2	22 1/2 x 34 1/2	22 1/2 x 46 1/2	30 1/2 x 30 1/2	30 1/2 x 46 1/2	34 1/2 x 34 1/2	37 1/2 x 37 1/2	46 1/2 x 22 1/2	46 1/2 x 30 1/2	46 1/2 x 46 1/2
Outside Curb	25 1/2 x 25 1/2	25 1/2 x 37 1/2	25 1/2 x 49 1/2	33 1/2 x 33 1/2	33 1/2 x 49 1/2	37 1/2 x 37 1/2	40 1/2 x 40 1/2	49 1/2 x 25 1/2	49 1/2 x 33 1/2	49 1/2 x 49 1/2
Maximum Skylight Clearance	26 5/8 x 26 5/8	26 5/8 x 38 5/8	26 5/8 x 50 5/8	34 5/8 x 34 5/8	34 5/8 x 50 5/8	38 5/8 x 38 5/8	41 5/8 x 41 5/8	50 5/8 x 26 5/8	50 5/8 x 34 5/8	50 5/8 x 50 5/8

Base Model	2222	2234	2246	3030	3046	3434	3737 <sup>1</sup>	4622 <sup>1</sup>	4630 <sup>1</sup>	4646
Standard Safety Glass										
Laminated LowE <sup>3</sup> Glass	-	-	-	-	-	-	-/F	-	-/F	-
Code 2004   Delivery S										

**Optional Models** Add price to base model; any size. Applies to standard sizes only.

Impact Glass <sup>2</sup>	White Laminated Glass
VCS only	VCS only
Code 2006   Delivery N	Code 2008   Delivery N

**Flashing** Adhesive underlayment included. VELUX flashing required for the 10-Year Installation Warranty.

	2222	2234	2246	3030	3046	3434	3746 <sup>1</sup>	4622 <sup>1</sup>	4630 <sup>1</sup>	4646
Step 10° - 60° Asphalt Shingles/Wood Shake/Slate 1/2 in. max thickness		-			-	-	-/F			-
Code ECL   Delivery S										
High Profile 14° - 60° Tile - over 3/4 in. thickness		-			-	-	N/A			-
Code ECW   Delivery S										

<sup>1</sup>Only available in VCS. <sup>2</sup>Not available in VCS 4646 or 4622 with Impact Glass. Lead time and size availability may vary from base model.

Order Code Example  $\frac{\text{VCS}}{\text{product}} + \frac{2246}{\text{size}} + \frac{2004}{\text{code}} + \frac{\text{CS00W}}{\text{shade}}$

# Unit Skylights

## Self-Flashed E-Class EVMS



**EVMS Solar**  
Fresh Air

Remote and insect screen included with EVMS skylight  
Shades not available



EVMS Roof Pitch

14° - 85°  
3:12 - 137:12

**Custom Sizes** 1-800-888-3589  
Call for pricing

**Remote Upgrade** Upgrade to the VELUX Touch:  
Simple control of multiple EVMS skylights with one remote  
See page 6 for more information

- Ready to install right out of the box shingle/slate/wood roofs up to 3/4" thickness.
- One-piece, impenetrable ultra-seal integrated flashing.
- Requires no sealants.



## How to Order Custom EVMS Skylights

We require exact rough opening (RO) dimensions for width and height.  
Up to 15 sq ft | Min RO: 22 1/4" W or H | Max RO: 48" W or 54" H | Delivery N

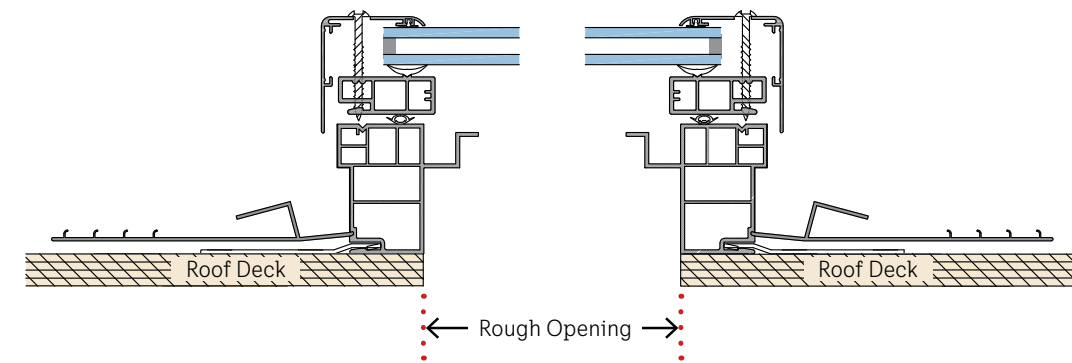

## Choose Your Glass

- Laminated       White Laminated

## EVMS Custom Finish Colors

VELUX Neutral Grey AAMA 2604 powder coat finish standard.  
Other custom finish colors are available, call 1-800-888-3589 for pricing and lead time information.

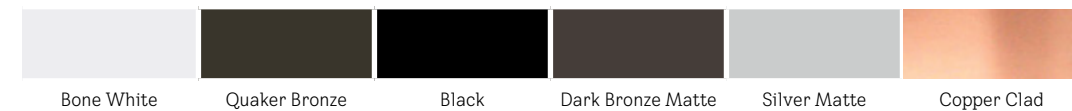

## How to Place Your Order

1. \_\_\_\_\_ Width  
(dimension parallel to ridge)
2. \_\_\_\_\_ Height
3. Call **1-800-888-3589**  
(for pricing)

# Unit Skylights

## Deck-Mounted VS



**VS Manual**  
Fresh Air

Insect screen and operating hook included with VS skylight. Operated by ZCT 300 control rod or crank handle ZZZ 201, sold separately.

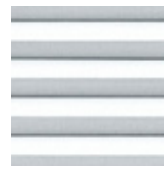

### Add a Solar-Powered Pre-Installed Shade

Room-Darkening, Double-Pleated White

#### CS00

See page 43 for special order shade options.



### VELUX App Control

Control your VELUX shades anytime, anywhere with your smartphone or smart home device.

Included free with pre-installed shade purchase.

App Control must be purchased separately for special order shades, see page 44.



### The New VELUX Touch











Control all of your shades from one touch screen remote control.

#### KLR 300 WW

See page 6 for more information.



All base models are available to have pre-installed shades, however, some optional skylight models may not be available. VELUX Customer Service will confirm availability. Manual Shades not available for VS model.

Standard Sizes (W-in. x H-in.)	C01	C04	C06	C08	M02	M04	M06	M08	S01	S06
 14° - 85° 3:12 - 137:12										
Outside Frame	21 1/2 x 27 3/8	21 1/2 x 38 3/8	21 1/2 x 46 1/4	21 1/2 x 54 15/16	30 9/16 x 30 1/2	30 9/16 x 38 3/8	30 9/16 x 46 1/4	30 9/16 x 54 15/16	44 3/4 x 27 3/8	44 3/4 x 46 1/4
Rough Opening	21 x 26 7/8	21 x 37 7/8	21 x 45 3/4	21 x 54 7/16	30 1/16 x 30	30 1/16 x 37 7/8	30 1/16 x 45 3/4	30 1/16 x 54 7/16	44 1/4 x 26 7/8	44 1/4 x 45 3/4

Base Model	C01	C04	C06	C08	M02	M04	M06	M08	S01	S06
Laminated LowE <sup>3</sup> Glass	-	-	-	-	-	-	-	-	-	-
Code 2004   Delivery S	-	-	-	-	-	-	-	-	-	-

**Optional Models<sup>1</sup>** Add price to base model; any size. Applies to standard sizes only.

Impact Glass Code 2006   Delivery N	Copper Cladding Code 2104   Delivery D	Snowload Glass Code 2010   Delivery A	Stain Grade Wood Interior Code 0004   Delivery D
--	---	--	---

**Flashing** Adhesive underlayment included. VELUX flashing required for the 10-Year Installation Warranty.

	C01	C04	C06	C08	M02	M04	M06	M08	S01	S06
Step Asphalt Shingles/Wood Shake/Slate 1/2 in. max thickness Code EDL   Delivery S	-	-	-	-	-	-	-	-	-	-
Copper Step Asphalt Shingles/Wood Shakes/Slate 1/2 in. max thickness Code EDL COPPER   Delivery D	-	-	-	-	-	-	-	-	-	-
High Profile Tile - over 3/4 in. thickness Code EDW   Delivery S	-	-	-	-	-	-	-	-	-	-
Metal Roof Code EDM   Delivery S	-	-	-	-	-	-	-	-	-	-
Biepack <sup>2</sup> Counter Flashing for Deck-Mounted Code ECB   Delivery S	-	-	-	-	-	-	-	-	-	-

<sup>1</sup> Lead time/size availability may vary from base model. <sup>2</sup> Adhesive underlayment not included.

Order Code Example  $\frac{VS}{\text{product}} + \frac{C06}{\text{size}} + \frac{2004}{\text{code}} + \frac{CS00W}{\text{shade}}$



# Unit Skylights

## Curb-Mounted VCM



**VCM Manual**  
Fresh Air

Insect screen and operating hook included with VCM skylight. Operated by ZCT 300 control rod or crank handle ZZZ 212, sold separately.

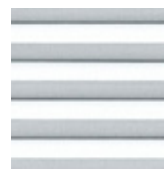

### Add a Solar-Powered Pre-Installed Shade

Room-Darkening, Double-Pleated White

#### CS00

See page 43 for special order shade options.



### VELUX App Control

Control your VELUX shades anytime, anywhere with your smartphone or smart home device.

Included free with pre-installed shade purchase.

App Control must be purchased separately for special order shades, see page 44.



### The New VELUX Touch

Control all of your shades from one touch screen remote control.

#### KLR 300 WW

See page 6 for more information.



All base models are available to have pre-installed shades, however, some optional skylight models may not be available. VELUX Customer Service will confirm availability. Manual Shades not available for VCM model.

Standard Sizes (W-in. x H-in.)	2222	2234	2246	3030	3046	3434	4646
Inside Curb	22 1/2 x 22 1/2	22 1/2 x 34 1/2	22 1/2 x 46 1/2	30 1/2 x 30 1/2	30 1/2 x 46 1/2	34 1/2 x 34 1/2	46 1/2 x 46 1/2
Outside Curb	25 1/2 x 25 1/2	25 1/2 x 37 1/2	25 1/2 x 49 1/2	33 1/2 x 33 1/2	33 1/2 x 49 1/2	37 1/2 x 37 1/2	49 1/2 x 49 1/2
Maximum Skylight Clearance	26 5/8 x 26 5/8	26 5/8 x 38 5/8	26 5/8 x 50 5/8	34 5/8 x 34 5/8	34 5/8 x 50 5/8	38 5/8 x 38 5/8	50 5/8 x 50 5/8
<b>Base Model</b>	<b>2222</b>	<b>2234</b>	<b>2246</b>	<b>3030</b>	<b>3046</b>	<b>3434</b>	<b>4646</b>
Laminated LowE <sup>3</sup> Glass	-	-	-	-	-	-	-
Code 2004   Delivery S							

**Optional Models<sup>1</sup>** Add price to base model; any size. Applies to standard sizes only.

Impact Glass Code 2006   Delivery N	White Laminated Glass 2222, 2246, 4646 only. Call for additional sizes Code 2008   Delivery N - Delivery A for 2222, 2246, 4646
--	---

In-Reach Application Model	2222	2234	2246	3030	3046	3434	4646
Tempered LowE <sup>3</sup> Glass Code 2005   Delivery T	-	-	-	-	-	-	-

**Flashing** Adhesive underlayment included. VELUX flashing required for the 10-Year Installation Warranty.

	2222	2234	2246	3030	3046	3434	4646
Step 10° - 60° Asphalt Shingles/Wood Shake/Slate 1/2 in. max thickness Code ECL   Delivery S		-		-		-	-
High Profile 14° - 60° Tile - over 3/4 in. thickness Code ECW   Delivery S		-		-		-	-

<sup>1</sup>Lead time/size availability may vary from base model.

Order Code Example  $\frac{\text{VCM}}{\text{product}} + \frac{2246}{\text{size}} + \frac{2004}{\text{code}} + \frac{\text{CS00W}}{\text{shade}}$

# Unit Skylights

## Self-Flashed E-Class EV



**EV Manual**  
Fresh Air

Insect screen and operating hook included with EV skylight. Operated by ZCT 300 control rod or crank handle ZZZ 201, sold separately. Shades not available.

Custom Sizes 1-800-888-3589  
Call for pricing

- Ready to install right out of the box shingle/slate/wood roofs up to 3/4" thickness.
- One-piece, impenetrable ultra-seal integrated flashing.
- Requires no sealants.



### Standard Sizes Available While Supplies Last

Standard Sizes (W-in. x H-in.)	2222	2230	2238	2246	2254	3030	3046	3054	4646
Rough Opening	22 1/2 x 22 1/2	22 1/2 x 30 1/2	22 1/2 x 38 1/2	22 1/2 x 46 1/2	22 1/2 x 54 1/2	30 1/2 x 30 1/2	30 1/2 x 46 1/2	30 1/2 x 54 1/2	46 1/2 x 46 1/2
Base Model	2222	2230	2238	2246	2254	3030	3046	3054	4646
Standard Safety Glass	-	-	-/R	-	-	-	-	-	-
Laminated LowE <sup>3</sup> Glass	-	-	-/R	-	-	-	-	-	-
Code 2004   Delivery T									

**Optional Models<sup>1</sup>** Add price to base model; any size.

White Laminated Glass  
Standard on 2222, 2246, 4646  
Code 2008 | Delivery N

Order Code Example  
 $\frac{EV}{product} + \frac{2246}{size} + \frac{2004}{code}$

## How to Order Custom EV Skylights

We require exact rough opening (RO) dimensions for width and height.

Up to 15 sq ft  
Min RO: 22 1/4" W or H  
Max RO: 48" W or 54" H

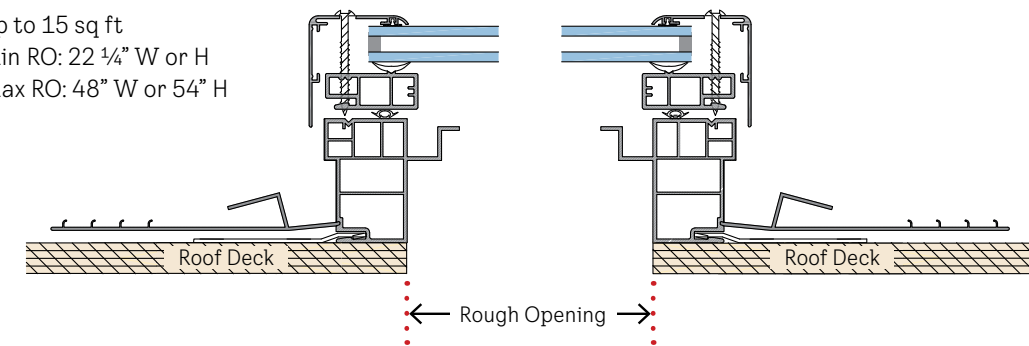

## EV Custom Finish Colors

VELUX Neutral Grey finish standard. Other custom finish colors are available, call 1-800-888-3589 for pricing and lead time information.

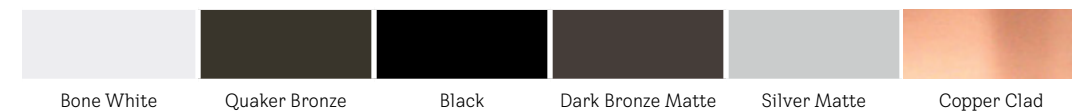

## How to Place Your Order

1. \_\_\_\_\_ Width  
(dimension parallel to ridge)
2. \_\_\_\_\_ Height
3. Call **1-800-888-3589**  
(for pricing)

# Unit Skylights

## Deck-Mounted FS



FS Fixed

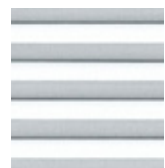

### Add a Solar-Powered Pre-Installed Shade

Room-Darkening, Double-Pleated White

#### CS00

See page 43 for special order shade options.



### VELUX App Control

Control your VELUX shades anytime, anywhere with your smartphone or smart home device.

Included free with pre-installed shade purchase.

App Control must be purchased separately for special order shades, see page 44.



### The New VELUX Touch

Control all of your shades from one touch screen remote control.

#### KLR 300 WW

See page 6 for more information.



HGTV  
**URBAN OASIS**  
PROUD SPONSOR  
— 2022 —

All base models are available to have pre-installed shades, however, some optional skylight models may not be available. VELUX Customer Service will confirm availability.

Standard Sizes (W-in. x H-in.)	A06	C01	C04	C06	C08	C12	D26	D06	M02	M04	M06	M08	S01	S06
 14° - 85° 3:12 - 137:12														

Outside Frame	15 1/4 x 46 1/4	21 1/2 x 27 3/8	21 1/2 x 38 3/8	21 1/2 x 46 1/4	21 1/2 x 54 15/16	21 1/2 x 70 3/4	23 1/4 x 23 7/16	23 1/4 x 46 1/4	30 9/16 x 30 1/2	30 9/16 x 38 3/8	30 9/16 x 46 1/4	30 9/16 x 54 15/16	44 3/4 x 27 3/8	44 3/4 x 46 1/4
Rough Opening	14 1/2 x 45 3/4	21 x 26 7/8	21 x 37 7/8	21 x 45 3/4	21 x 54 7/16	21 x 70 1/4	22 1/2 x 22 15/16	22 1/2 x 45 3/4	30 1/16 x 30	30 1/16 x 37 7/8	30 1/16 x 45 3/4	30 1/16 x 54 7/16	44 1/4 x 26 7/8	44 1/4 x 45 3/4

Base Model	A06	C01	C04	C06	C08	C12	D26	D06	M02	M04	M06	M08	S01	S06
Standard Safety Glass														
Laminated LowE <sup>3</sup> Glass	-	-	-	-	-	-	-	-	-	-	-	-	-	-
Code 2004   Delivery S														

**Optional Models<sup>1</sup>** Add price to base model; any size. Applies to standard sizes only.

Impact Glass excluding C12. Code 2006   Delivery N except for A06, C01, C08, M02, S01	Copper Cladding Code 2104   Delivery D	Snowload Glass excludes C12, D26, D06 Code 2010   Delivery A	Stain Grade Wood Interior Code 0004   Delivery D
--	---	--	---

**Flashing** Adhesive underlayment included. VELUX flashing required for the 10-Year Installation Warranty.

	A06	C01	C04	C06	C08	C12	D26	D06	M02	M04	M06	M08	S01	S06
Step Asphalt Shingles/Wood Shake/Slate 1/2 in. max thickness Code EDL   Delivery S	-	-	-	-	-	-	-	-	-	-	-	-	-	-
Copper Step Asphalt Shingles/Wood Shakes/Slate 1/2 in. max thickness Code EDL COPPER   Delivery D	-	-	-	-	-	-	-	-	-	-	-	-	-	-
High Profile Tile - over 3/4 in. thickness Code EDW   Delivery S	N/A	-	-	-	-	-	-	-	-	-	-	-	-	-
Metal Roof Code EDM   Delivery S	-	-	-	-	-	-	-	-	-	-	-	-	-	-
Biepack <sup>2</sup> Counter Flashing for Deck-Mounted Code ECB   Delivery S	N/A	-	-	-	-	N/A	N/A	-	-	-	-	-	-	-

<sup>1</sup>Lead time/size availability may vary from base model. <sup>2</sup>Adhesive underlayment not included.

Order Code Example  $\frac{\text{FS}}{\text{product}} + \frac{\text{C06}}{\text{size}} + \frac{\text{2004}}{\text{code}} + \frac{\text{CS00W}}{\text{shade}}$

# Unit Skylights

## Curb-Mounted FCM



FCM Fixed

Shades not available on 1430, 1446, 3055, 4672

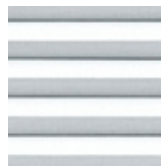

### Add a Solar-Powered Pre-Installed Shade

Room-Darkening, Double-Pleated White

#### CS00

See page 43 for special order shade options.



### VELUX App Control

Control your VELUX shades anytime, anywhere with your smartphone or smart home device.

Included free with pre-installed shade purchase.

App Control must be purchased separately for special order shades, see page 44.



### The New VELUX Touch

Control all of your shades from one touch screen remote control.

#### KLR 300 WW

See page 6 for more information.

Factory installed shades for FCM skylights includes accessory tray.

Most base models are available to have pre-installed shades, however, some optional skylight models may not be available. VELUX Customer Service will confirm availability.



Standard Sizes (W-in. x H-in.)	1430	1446	2222	2230	2234	2246	2270	3030	3046	3055	3434	3446	4646	4672
0° - 60° 0.12 - 20:12														
Inside Curb	14 1/2 x 30 1/2	14 1/2 x 46 1/2	22 1/2 x 22 1/2	22 1/2 x 30 1/2	22 1/2 x 34 1/2	22 1/2 x 46 1/2	22 1/2 x 70 1/2	30 1/2 x 30 1/2	30 1/2 x 46 1/2	30 1/2 x 55 1/2	34 1/2 x 34 1/2	34 1/2 x 46 1/2	46 1/2 x 46 1/2	46 1/2 x 72 1/2
Outside Curb	17 1/2 x 33 1/2	17 1/2 x 49 1/2	25 1/2 x 25 1/2	25 1/2 x 33 1/2	25 1/2 x 37 1/2	25 1/2 x 49 1/2	25 1/2 x 73 1/2	33 1/2 x 33 1/2	33 1/2 x 49 1/2	33 1/2 x 58 1/2	37 1/2 x 37 1/2	37 1/2 x 49 1/2	49 1/2 x 49 1/2	49 1/2 x 75 1/2
Maximum Skylight Clearance	18 5/8 x 34 5/8	18 5/8 x 50 5/8	26 5/8 x 26 5/8	26 5/8 x 34 5/8	26 5/8 x 38 5/8	26 5/8 x 50 5/8	26 5/8 x 74 5/8	34 5/8 x 34 5/8	34 5/8 x 50 5/8	34 5/8 x 59 5/8	38 5/8 x 38 5/8	38 5/8 x 50 5/8	50 5/8 x 50 5/8	50 5/8 x 76 5/8

Base Model	1430	1446	2222	2230	2234	2246	2270	3030	3046	3055	3434	3446	4646	4672
Standard Safety Glass														
Laminated LowE <sup>3</sup> Glass	-/T	-	-	-	-	-	-	-	-	-	-	-	-	-/F
Code 0004   Delivery S														

Optional Models<sup>1</sup> Add price to base model; any size. Applies to standard sizes only.

Impact Glass	White Laminated Glass	Triple Pane Glass
not available on 2270, 3055, 4672	for 1430, 1446, 2230, 3055, 3446, 4672 call for pricing	2222, 2246, 4646 only, call for pricing
Code 0006   Delivery N	Code 0008   Delivery R	Code 0029   Delivery R

In-Reach Application Model	1430	1446	2222	2230	2234	2246	2270	3030	3046	3055	3434	3446	4646	4672
Tempered LowE <sup>3</sup> Glass	-	-	-	-	-	-	-	-	-	N/A	-	N/A	-	N/A
Code 0005   Delivery S														

Flashing Adhesive underlayment included. VELUX flashing required for the 10-Year Installation Warranty.

	1430	1446	2222	2230	2234	2246	2270	3030	3046	ECL 3055 S0000C	3434	3446	4646	ECL 4672 S0000C
Step 10° - 60° Asphalt Shingles/Wood Shake/Slate 1/2 in. max thickness	-	-	-	-	-	-	-	-	-	-*	-	-	-	-*
Code ECL   Delivery S														
High Profile 14° - 60° Tile - over 3/4 in. thickness	-	-	-	-	-	-	-	-	-	N/A	-	-	-	N/A
Code ECW   Delivery S														

\*Includes extra step flashing and adhesive underlayment.

<sup>1</sup>Lead time/size availability may vary from base model.

Order Code Example  $\frac{\text{FCM}}{\text{product}} + \frac{\text{2246}}{\text{size}} + \frac{\text{2004}}{\text{code}} + \frac{\text{CS00W}}{\text{shade}}$

# Unit Skylights

## Curb-Mounted Custom Size FCM



FCM Fixed

Flashings and shades not available on custom FCM sizes.



FCM roof pitch

### Custom Size FCM

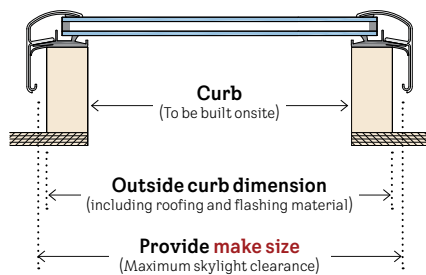

- We require maximum skylight clearance dimensions in 1/4" increments (0, 1/4, 1/2, 3/4) for width and height.
- Custom size flashing kits and shades are not available
- Some specialty glass options require longer lead times

### Call for pricing and availability

Width	18 <sup>3</sup> / <sub>4</sub> to 50 <sup>3</sup> / <sub>4</sub>
Length	18 <sup>3</sup> / <sub>4</sub> to 76 <sup>1</sup> / <sub>2</sub>
Allow	15 days or less



Standard Sizes	190365	190435	210455	225225	225470	245245	245470	245490	260540	280525
Flashed Outside Curb Width Range	22 - 23 1/2	22 - 23 1/2	24 - 25 1/2	25 1/2 - 27	25 1/2 - 27	27 1/2 - 29	27 1/2 - 29	27 1/2 - 29	29 - 30 1/2	31 - 32 1/2
Flashed Outside Curb Height Range	39 1/2 - 41	46 1/2 - 48	48 1/2 - 50	25 1/2 - 27	50 - 51 1/2	27 1/2 - 29	50 - 51 1/2	52 - 53 1/2	57 - 58 1/2	55 1/2 - 57
Maximum Skylight Clearance (W" or H")	23 5/8 x 41 1/8	23 5/8 x 48 1/8	25 5/8 x 50 1/8	27 1/8 x 27 1/8	27 1/8 x 51 5/8	29 1/8 x 29 1/8	29 1/8 x 51 5/8	29 1/8 x 53 5/8	30 5/8 x 58 5/8	32 5/8 x 57 1/8
	190365	190435	210455	225225	225470	245245	245470	245490	260540	280525
Laminated LowE <sup>3</sup> Glass Code 0004D   Delivery C	-	-	-	-	-	-	-	-	-	-

Standard Sizes Continued	315315	315470	315700	315715	365365	385385	385540	420435	460470	460700
Flashed Outside Curb Width Range	34 1/2 - 36	34 1/2 - 36	34 1/2 - 36	34 1/2 - 36	39 1/2 - 41	41 1/2 - 43	41 1/2 - 43	45 - 46 1/2	49 - 50 1/2	49 - 50 1/2
Flashed Outside Curb Height Range	34 1/2 - 36	50 - 51 1/2	73 - 74 1/2	74 1/2 - 76	39 1/2 - 41	41 1/2 - 43	57 - 58 1/2	46 1/2 - 48	50 - 51 1/2	73 - 74 1/2
Maximum Skylight Clearance (W" or H")	36 1/8 x 36 1/8	36 1/8 x 51 5/8	36 1/8 x 74 5/8	36 1/8 x 76 1/8	41 1/8 x 41 1/8	43 1/8 x 43 1/8	43 1/8 x 58 5/8	46 5/8 x 48 1/8	50 5/8 x 51 5/8	50 5/8 x 74 5/8
	315315	315470	315700	315715	365365	385385	385540	420435	460470	460700
Laminated LowE <sup>3</sup> Glass Code 0004D   Delivery C	-	-	-	-	-	-	-	-	-	-

## Flashed Outside Curb Range

Standard clearance between flashed outside curb and counterflashing leg:

FCM can accommodate a smaller curb (-3/4") and still use the same skylight. Longer screws are provided as distance between the flashed outside curb and counterflashing increases.

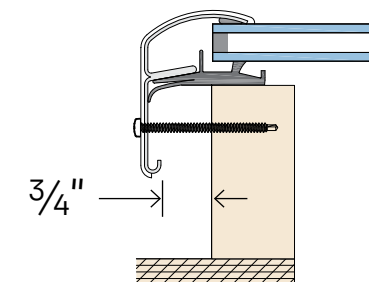
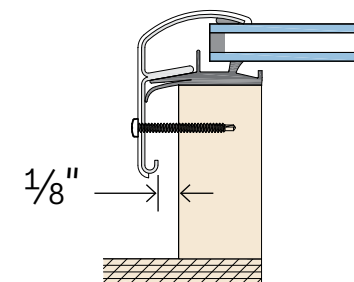

# Unit Skylights

## Self-Flashed QPF



QPF Fixed

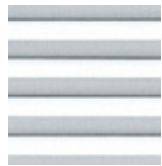

### Add a Solar-Powered Pre-Installed Shade

Room-Darkening, Double-Pleated White

#### CS00

See page 43 for special order shade options.



### VELUX App Control

Control your VELUX shades anytime, anywhere with your smartphone or smart home device.

Included free with pre-installed shade purchase.

App Control must be purchased separately for special order shades, see page 44.



### The New VELUX Touch

Control all of your shades from one touch screen remote control.

#### KLR 300 WW

See page 6 for more information.



Standard Sizes (W-in. x H-in.)	2222	2230	2246	3030	3046	4646
10° - 60° 2:12 - 20:12						
Outside Flashing	29 5/8 x 29 5/8	29 5/8 x 37 5/8	29 5/8 x 53 5/8	37 5/8 x 37 5/8	37 5/8 x 53 5/8	53 5/8 x 53 5/8
Rough Opening/ Finished Frame	22 1/2 x 22 1/2	22 1/2 x 30 1/2	22 1/2 x 46 1/2	30 1/2 x 30 1/2	30 1/2 x 46 1/2	46 1/2 x 46 1/2

Base Model	2222	2230	2246	3030	3046	4646
Standard Safety Glass Laminated LowE <sup>3</sup> Glass Code 2004   Delivery S	-	-	-	-	-	-

**Optional Models<sup>1</sup>** Add price to base model; any size. Applies to standard sizes only.

Impact Glass Code 2006   Delivery N	White Laminated Glass Code 2008   Delivery N
--	---

In-Reach Application Model	2222	2230	2246	3030	3046	4646
Tempered LowE <sup>3</sup> Glass Code 2005   Delivery S	-	-	-	-	-	-

<sup>1</sup>Lead time/size availability may vary from base model.

Order Code Example  $\frac{\text{QPF}}{\text{product}} + \frac{\text{2246}}{\text{size}} + \frac{\text{2004}}{\text{code}} + \frac{\text{CS00W}}{\text{shade}}$

# Unit Skylights

## Self-Flashed E-Class EF



EF Fixed

Factory installed shades for EF skylights include accessory tray. Shades not available on 2238, 2254, 3054, or custom sizes

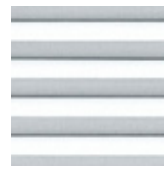

### Add a Solar-Powered Pre-Installed Shade

Room-Darkening, Double-Pleated White

#### CS00

See page 43 for special order shade options.



### VELUX App Control

Control your VELUX shades anytime, anywhere with your smartphone or smart home device.

Included free with pre-installed shade purchase.

App Control must be purchased separately for special order shades, see page 44.



### The New VELUX Touch

Control all of your shades from one touch screen remote control.

#### KLR 300 WW

See page 6 for more information.

All base models are available to have pre-installed shades, however, some optional skylight models may not be available. VELUX Customer Service will confirm availability.



### Standard Sizes Available While Supplies Last

Standard Sizes (W-in. x H-in.)	2222	2230	2238	2246	2254	3030	3046	3054	4646
Rough Opening	22 1/2 x 22 1/2	22 1/2 x 30 1/2	22 1/2 x 38 1/2	22 1/2 x 46 1/2	22 1/2 x 54 1/2	30 1/2 x 30 1/2	30 1/2 x 46 1/2	30 1/2 x 54 1/2	46 1/2 x 46 1/2
Base Model	2222	2230	2238	2246	2254	3030	3046	3054	4646
Laminated LowE <sup>3</sup> Glass	-	-	-/N	-	-/N	-	-	-/N	-
Code 2004   Delivery T									

**Optional Models<sup>1</sup>** Add price to base model; any size. Applies to standard sizes only.

Impact Glass Code 2006   Delivery N	White Laminated Glass Code 2008   Delivery N	Order Code Example	EF product	+	2246 size	+	2004 code	+	CS00 shade
--	---	--------------------	---------------	---	--------------	---	--------------	---	---------------

<sup>1</sup>Lead time/size availability may vary from base model.

## How to Order Custom EF Skylights

We require exact rough opening (RO) dimensions for width and height.

Up to 23 sq ft  
Min RO: 14 1/2" W or H  
Max RO: 72" W or H

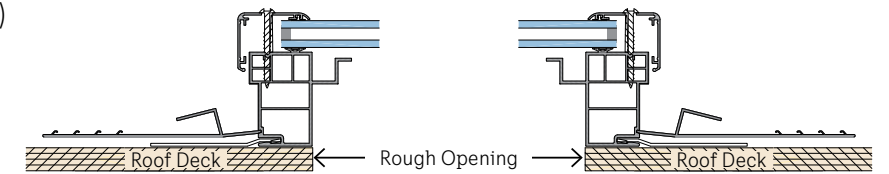

## EF Custom Finish Colors

VELUX Neutral Grey finish standard. Other custom finish colors are available, call 1-800-888-3589 for pricing and lead time information.



## How to Place Your Order

- \_\_\_\_\_ Width  
(dimension parallel to ridge)
- \_\_\_\_\_ Height
- Call **1-800-888-3589**  
(for pricing and lead time)

# Unit Skylights

## Curb-Mounted SkyMax GSM



GSM Fixed

Custom Sizes up to 35 sq ft  
 1-800-888-3589  
 Call for pricing

- Sizes are based upon the outside curb dimension (OCD).
- For use with site-built curb and flashing minimum 3 1/2 curb.
- Available custom finish colors and copper cladding.



Standard Sizes (W-in. x H-in.)	4896	5199
1° - 60° 1/4:12 - 20:12		
Inside Curb Dimension	45 x 93	48 x 96
Outside Curb Dimension	48 x 96	51 x 99
Max Skylight Clearance	49 1/4 x 97 1/4	52 1/4 x 100 1/4
<b>Base Model</b>	<b>4896</b>	<b>5199</b>
Solarban 70XL Clear Code 0090	-/B	-/R

**Optional Models<sup>1</sup>** Other glass options available as custom.

<sup>1</sup>Lead time/size availability may vary from base model. Additional models do not apply to custom sizes.

Order Code Example  $\frac{\text{GSM}}{\text{product}} + \frac{4896}{\text{size}} + \frac{0090}{\text{code}}$

Call 1-800-888-3589 for sizes 4896 and 5199 listed above.

## How to Order Custom SkyMax GSM Skylights

We require exact outside curb dimensions (OCD) for width and height

Up to 35 sq ft (OCD)  
 Min OCD: 17 1/2" W or H  
 Max OCD: 120" W or H

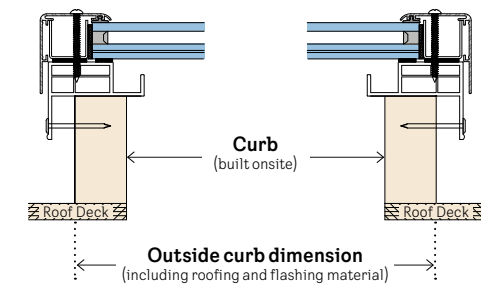

## GSM Custom Finish Colors

VELUX Neutral Grey finish standard. Other custom finish colors are available, call 1-888-878-3589 for pricing and lead time information.

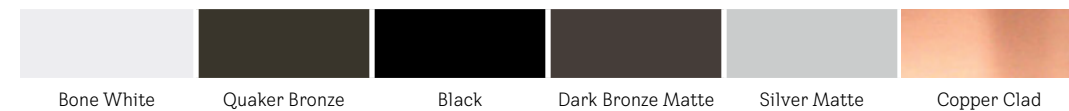

## How to Place Your Order

1. \_\_\_\_\_ Width  
(dimension parallel to ridge)
2. \_\_\_\_\_ Height
3. Call **1-800-888-3589**  
(Call Customer Service for custom size pricing)



# Sun Tunnel® Skylights

## Rigid & Flex Tube



**TGR**

Rigid One-piece Low-profile Metal Flashing



**TGF**

Flexible One-piece Low-profile Metal Flashing



**TMR**

Rigid Pitched One-piece Metal Flashing



**TMF**

Flexible Pitched One-piece Metal Flashing

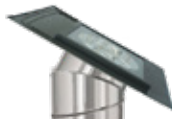

**TLR**

Rigid Low-profile Flat Glass



**TCR**

Rigid Curb Metal Flashing



Roof Pitch:  
14° - 60°  
3:12 - 20:12  
TGR, TMR, TSR,  
TGF, TMF, TLR



Roof Pitch:  
0° - 60°  
0:12 - 20:12  
TCR

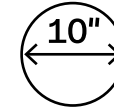

10" Sun Tunnel	TGR 010	TSR 010	TMR 010
Tube length with kit Rigid kits include 2 elbows & 24" extension	48"	48"	48"
Tube type	Rigid	Rigid	Rigid
Maximum recommended installation length	20'	20'	20'

Dome/Flashing	TGR 010	TSR 010	TMR 010
Acrylic Dome Shingle/shake roof Code 0000   Delivery S	—	N/A	—
Impact Dome Shingle/shake roof Code 1000   Delivery T	—	N/A	—
Acrylic Dome Plastic/metal flashing - shingle/shake roof Code 0000   Delivery S	N/A	—	N/A

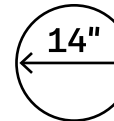

14" Sun Tunnel	TGR 014	TMR 014	TLR 014	TCR 014	TMF 014	TGF 014
Tube length with kit Rigid kits include 2 elbows & 24" extension	48"	48"	48"	48"	8'	8'
Tube type	Rigid	Rigid	Rigid	Rigid	Flexible	Flexible
Maximum recommended installation length	30'	30'	30'	30'	8'	8'

Dome/Flashing	TGR 014	TMR 014	TLR 014	TCR 014	TMF 014	TGF 014
Flat Glass Shingle/shake roof Code 2000   Delivery S	N/A	N/A	—	N/A	N/A	N/A
Acrylic Dome Shingle/shake roof Code 0000   Delivery S	—	—	N/A	—	—	—
Impact Dome Shingle/shake roof Code 1000   Delivery T	—	—	N/A	—	—	—

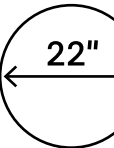

22" Sun Tunnel	TGF 022	TGR 022
Tube length with kit Rigid kits include 2 elbows & 24" extension Subtract approximately 6" for flashing	8'	48"
Tube type	Flexible	Rigid
Maximum recommended installation length	12'	40'

Dome/Flashing	TGF 022	TGR 022
Acrylic Dome Shingle Code 0000   Delivery S	—	N/A
Impact Dome Shingle Code 1000   Delivery T	—	N/A
Acrylic Dome Shingle - ships in multiple boxes Code S0000   Delivery F	N/A	—
Impact Dome Shingle - ships in multiple boxes Code S1000   Delivery F	N/A	—

Free light.  
Day or night.

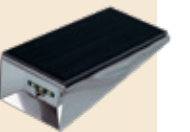

Designed to fit inside the rigid tube of a VELUX Sun Tunnel® skylight, the **VELUX Solar Night Light** gives off a soft, soothing glow from above when natural light isn't available. The night light's solar panel collects available sunlight, even on cloudy days, to power its rechargeable batteries.

Sun Tunnel accessories on pages 46 and 47.

Order Code Example  $\frac{\text{TMR}}{\text{product}} + \frac{\text{010}}{\text{size}} + \frac{\text{0000}}{\text{code}} + \frac{\text{SL}}{\text{light}}$

# Sun Tunnel® Skylights

## Wildfire & Impact Glass



**TZR/TZRL**  
Wildfire or Impact Glass  
Curb-Mount



**TZRQ**  
Wildfire or Impact Glass  
Pan-Flushed



Roof Pitch  
TZR



Roof Pitch  
TZRL / TZRQ

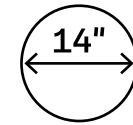

Model	TZR 014	TZRL 014	TZRQ 014
Tube length with kit Rigid kits include 2 elbows & 24" extension	64"	64"	52"
Tube type	Rigid	Rigid	Rigid
Maximum recommended installation length	30'	30'	30'
Flashing	Not included	Step-flashing Included	Pan-flashed

Glass Options	TZR 014	TZRL 014	TZRQ 014
Wildfire Glass Shingle/tile (TZR), shingle (TZRL, TZRQ) Code 2A00   Delivery F	–	–	–
Impact Glass Shingle/tile (TZR), shingle (TZRL, TZRQ) Code 1A00   Delivery T	–	–	–

Flashing	TZR 014	TZRL 014	TZRQ 014
ECW 014Z Curb Mounted Flashing - Shingle/tile Delivery F	–	Order TZR <sup>2</sup>	N/A
ECL Curb Mounted Flashing - Shingle	Order TZR <sup>1</sup>	Included	N/A

<sup>1</sup> TZRL is a TZR with an ECL flashing kit included. <sup>2</sup> Order as a TZR with ECW 014Z.



Diamond Wire  
Wildfire Glass

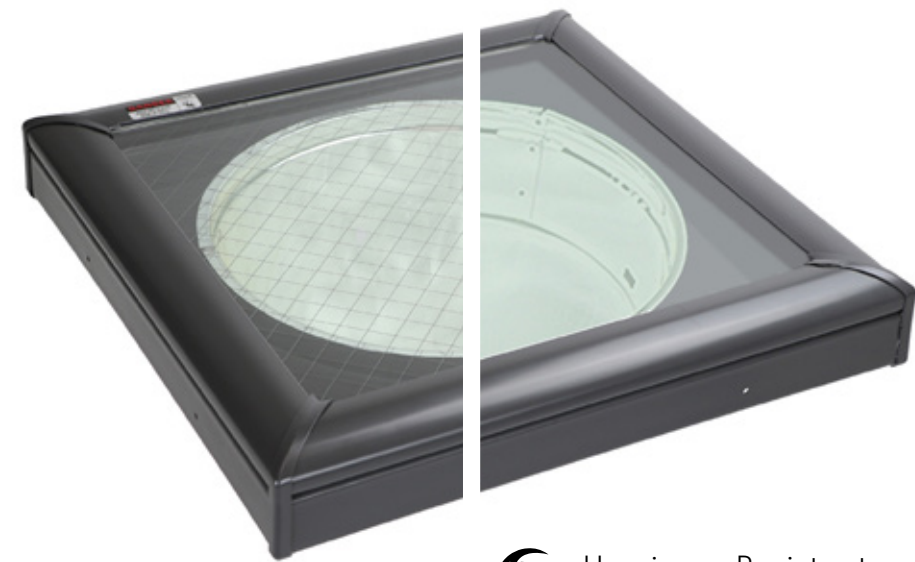

Hurricane Resistant  
Impact Glass

# Flat Roof Skylights

## Curb-Mounted Domed Units

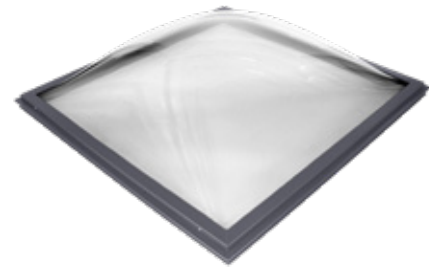

**FXG Acrylic Double Dome**

Custom Sizes 1-800-888-3589  
Call for pricing

- Neutral gray exterior color.
- Encapsulated inner frame is 100% thermally broken.

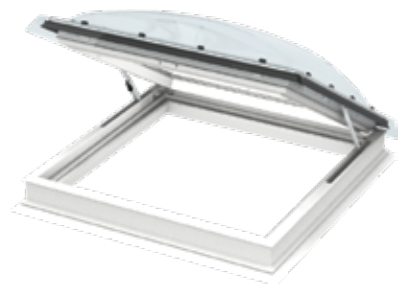

**CXP Hatch with ISD Polycarbonate Protective Cover**

- Opens manually up to 60° for roof access.
- Highly impact resistant domed polycarbonate outer with inner laminated glass pane for added safety, sound control, and thermal protection.
- Insulated PVC frame.



## Acrylic Double Dome FXG

Standard Sizes (W-in. x H-in.) (previous size)	225225	225465	305305	345345	465465
Outside Curb	25 1/2 x 25 1/2	25 1/2 x 49 1/2	33 1/2 x 33 1/2	37 1/2 x 37 1/2	49 1/2 x 49 1/2
Maximum Skylight Clearance	26 11/16 x 26 11/16	26 11/16 x 50 11/16	34 11/16 x 34 11/16	38 11/16 x 38 11/16	50 11/16 x 50 11/16
<b>Glazing</b>	<b>225225</b>	<b>225465</b>	<b>305305</b>	<b>345345</b>	<b>465465</b>
Clear over clear <b>Code 0A1A1</b>	-/S	-/S	-/S	-/S	-/S
Clear over white <b>Code 0A1A2</b>	-/R	-/R	-/R	-/R	-/R

Please contact Customer Service 800-888-3589 for sizes above in bronze over clear glazing.

## Hatch CXP with Polycarbonate Top Cover ISD

(Both are required)

Standard Sizes (W-in. x H-in.)	090120	100100	120120
Rough Opening	35 7/16 x 47 1/4	39 3/8 x 39 3/8	47 1/4 x 47 1/4
Exterior Frame	42 1/2 x 54 5/16	46 7/16 x 46 7/16	54 5/16 x 54 5/16
<b>Top Cover</b>	<b>090120</b>	<b>100100</b>	<b>120120</b>
Polycarbonate ISD <b>Code 0010</b>   Delivery G	-	-	-
<b>Base Unit (Required)</b>	<b>090120</b>	<b>100100</b>	<b>120120</b>
Hatch CXP <b>Code 0473Q</b>   Delivery G	-	-	-

Note: Must order both base unit and top cover to make a complete skylight unit. Base and cover will ship and invoice separately.

# Flat Roof Skylights

## Curb-Mounted CFU/ISU



**CFU Fixed Base with ISU CurveTech Protective Top Cover**



**CFU Fixed Base**

- Laminated thermal pane for added safety, sound control, and thermal protection.



**ISU CurveTech Protective Top Cover**

- CurveTech glass lets rainwater easily roll off for a clean look while preventing leaks.
- Tempered glass is virtually scratch-proof, providing a durable layer of protection.
- Unique curved glass with a modern and innovative design.



## Curb-Mounted CFU/ISU

Standard Sizes (W-in. x H-in.)	060060	080080	090060	120090	120120
Rough Opening	23 11/16 x 23 11/16	31 9/16 x 31 9/16	35 1/2 x 23 11/16	47 5/16 x 35 1/2	47 5/16 x 47 5/16
Exterior Frame	32 1/16 x 32 1/16	39 15/16 x 39 15/16	43 7/8 x 32 1/16	55 11/16 x 43 7/8	55 11/16 x 55 11/16
Standard Sizes Continued (W-in. x H-in.)	090090	100100	150100	150150	200100
Rough Opening	35 1/2 x 35 1/2	39 7/16 x 39 7/16	59 1/8 x 39 7/16	59 1/8 x 59 1/8	78 3/4 x 39 7/16
Exterior Frame	43 7/8 x 43 7/8	47 13/16 x 47 13/16	67 1/2 x 47 13/16	67 1/2 x 67 1/2	87 3/16 x 47 13/16

## CFU Fixed Base Unit

ISU Top Cover required when purchasing CFU fixed base unit

Standard Sizes	060060	080080	090060	120090	120120
Code 0020Q   Delivery G	-	-	-	-	-
Standard Sizes	090090	100100	150100	150150	200100
Code 0020Q   Delivery N	-	-	-	-	-

## ISU Top Cover

Standard Sizes	060060	080080	090060	120090	120120
Code 1093   Delivery G	-	-	-	-	-
Standard Sizes	090090	100100	150100	150150	200100
Code 1093   Delivery N	-	-	-	-	-

Note: Must order both base unit and top cover to make a complete skylight unit. Base and cover will ship and invoice separately.

# Skylight Flashing

## Deck-Mounted Combi-Flashing™



### EKL

low-profile roofing material  
shingles/shakes

### EKW

high-profile roofing material  
tile/corrugated metal



EKL/EKW Roof Pitch

14° - 85°  
3:12 - 137:12

- Combi-Flashing™ allows for large installations of multiple skylights.
- Must specify vertical gutter spacing when ordering. May be from 2.5" to 12" in 1/2" increments. Combi-Flashings™ with gutters 4.5" or wider have additional charges.
- Only the 2 1/2", 3", 3 1/2" and 4" gutters are stocked; all other widths are special order and carry a 15-day production time.
- 1 x (over/under) combinations have 4" horizontal gutter only.
- EKW has 4" gutter side by side configuration only.
- Gutter sizes listed are frame to frame – RO to RO will be 1/2" larger, ex. 3" listed gutter = 3 1/2" RO to RO.



HGTW  
**URBAN OASIS**  
PROUD SPONSOR  
— 2022 —

Sizes		C01	C04	C06	C08	C12	M02	M04	M06	M08	S01	S06
1 by 2 Flashing Configuration	<input type="checkbox"/> <input type="checkbox"/> EKL Low-Profile Delivery T	-	-	-	-	-	-	-	-	-	-	-
1 by 3 Flashing Configuration	<input type="checkbox"/> <input type="checkbox"/> <input type="checkbox"/> EKL Low-Profile Delivery T	-	-	-	-	-	-	-	-	-	-	-
2 by 1 Flashing Configuration	<input type="checkbox"/> <input type="checkbox"/> EKL Low-Profile Delivery T	-	-	-	-	-	-	-	-	-	-	-
	<input type="checkbox"/> <input type="checkbox"/> EKW High-Profile Delivery T	Call	Call	Call	N/A	N/A	Call	Call	Call	Call	Call	Call
2 by 2 Flashing Configuration	<input type="checkbox"/> <input type="checkbox"/> <input type="checkbox"/> <input type="checkbox"/> EKL Low-Profile Delivery T	-	-	-	-	-	-	-	-	-	-	-
2 by 3 Flashing Configuration	<input type="checkbox"/> <input type="checkbox"/> <input type="checkbox"/> <input type="checkbox"/> <input type="checkbox"/> EKL Low-Profile Delivery T	-	-	-	-	-	-	-	-	-	-	-
3 by 1 Flashing Configuration	<input type="checkbox"/> <input type="checkbox"/> <input type="checkbox"/> EKL Low-Profile Delivery T	-	-	-	-	-	-	-	-	-	-	-
	<input type="checkbox"/> <input type="checkbox"/> <input type="checkbox"/> EKW High-Profile Delivery T	-	-	-	N/A	N/A	-	-	-	-	-	-
3 by 2 Flashing Configuration	<input type="checkbox"/> <input type="checkbox"/> <input type="checkbox"/> <input type="checkbox"/> <input type="checkbox"/> EKL Low-Profile Delivery T	-	-	-	-	-	-	-	-	-	-	-
4 by 1 Flashing Configuration	<input type="checkbox"/> <input type="checkbox"/> <input type="checkbox"/> <input type="checkbox"/> EKL Low-Profile Delivery T	-	-	-	-	-	-	-	-	-	-	-
	<input type="checkbox"/> <input type="checkbox"/> <input type="checkbox"/> <input type="checkbox"/> EKW High-Profile Delivery T	--	-	-	N/A	N/A	-	-	-	-	-	-

Many other combinations can be made beyond what is listed in the pricing chart. Call customer service for more combi-flashing™ options and pricing. Measurement must be taken from rough opening to rough opening.

Large orders may require longer lead times. Combi-flashings™ are not available for models FCM, VCM, VCE, QPF, or VCS. VSS is not available in 1 by 3 or 2 by 3 configurations due to the solar panel.

# Skylight Accessories

## Shades



### Room-Darkening Double-Pleated

Unique honeycomb structure adds an extra layer of fabric to block bright sunlight.



### Light-Filtering Single-Pleated

The single-pleated shades softly diffuse natural light, helping prevent glare.

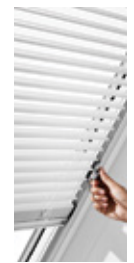

### Venetian

Available for roof windows only

Lightweight, horizontal slats provide style and easy light control for any room.

Model and size code on your skylight:

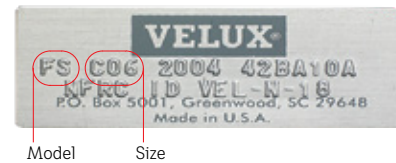

Order code example:

FSCD	C06	1045SWL
shade model	+ skylight size	+ color code



HGTV  
**URBAN OASIS**  
PROUD SPONSOR  
2023

# Solar-Powered Skylight Shades

Available for factory installation

## In-Stock Skylight Shade Options<sup>1</sup>

Room-Darkening, Double-Pleated

Skylight Model	Code	Price
VSS/VSE	FSCH	—
VS	FSCH	—
FS	FSCD	—
VCS/VCE/VCM/QPF	FSCC	—
FCM	FSCC	—*

1045 White

\* FCM price includes accessory tray.

## Special Order Skylight Shade Options<sup>2</sup>

Room-Darkening, Double-Pleated

1155 Beige	1163 Grey	1164 Grey Melange	1171 Dark Sand	1172 Light Grey
1047 Charcoal	1049 Golden Beige	1156 Blue	1165 Light Brown	1173 Petrol
1168 Dusty Green	1169 Light Blue	1170 Dark Taupe	1166 Ivory	1167 Orange

Light Filtering, Single-Pleated

1256 Classic White	1259 Classic Sand	1275 Natural	1282 Dark Grey	1286 Jeans Blue
1016 White	1274 Charcoal	1276 Dusty Brown	1277 Dusty Sand	1278 Beige
1280 Forest Green	1281 Mint Green	1283 Light Beige	1284 Grey	1285 Soft Blue
1279 Red Wine				

Skylight Model	Code	Price
VSS/VSE	FSCH	—
VS	FSCH	—
FS	FSCD	—
VCS/VCE/VCM/QPF	FSCC	—
FCM	FSCC	—*

\* FCM = shade price + accessory tray

# Manual Roof Window Shades

Ships separately from Roof Window

## In-Stock Roof Window Shade Options<sup>1</sup>

Room Darkening, Double Pleated

Roof Window Model	Code	Price
GPU/GXU/GGU	FHC	—
GDL <sup>6</sup>	FHC	—

1045 White

Light Filtering, Single Pleated

Roof Window Model	Code	Price
GPU/GXU/GGU	FHL	—
GDL <sup>5</sup>	FHL	—

1016 White

Venetian

Roof Window Model	Code	Price
GPU/GXU/GGU	PAL	—
GDL <sup>5</sup>	PAL	—

7001 White

Slats measure 1.375"

## Special Order Roof Window Shade Options<sup>2</sup>

Room-Darkening, Double-Pleated

1155 Beige	1163 Grey	1164 Grey Melange	1171 Dark Sand	1172 Light Grey
1047 Charcoal	1049 Golden Beige	1156 Blue	1165 Light Brown	1173 Petrol
1168 Dusty Green	1169 Light Blue	1170 Dark Taupe	1166 Ivory	1167 Orange

Light Filtering, Single-Pleated

1256 Classic White	1259 Classic Sand	1275 Natural	1282 Dark Grey	1286 Jeans Blue
1274 Charcoal	1276 Dusty Brown	1277 Dusty Sand	1278 Beige	1280 Forest Green
1281 Mint Green	1283 Light Beige	1284 Grey	1285 Soft Blue	1279 Red Wine

Roof Window Model	Code - Room Darkening	Code - Light Filtering	Price
GPU/GXU/GGU	FHC	FHL	—
GDL <sup>3</sup>	FHC	FHL	—

<sup>1</sup>In-Stock: Solar skylight shades available for factory installation, 2-4 business days. Custom sizes must be placed as special order. Manual roof window shades not eligible for factory installation. <sup>2</sup>Special Order: No factory installation for special order skylight or roof window shades. Shades ship separately: skylights 14 business days and roof windows up to 8 weeks. <sup>3</sup>GDL requires two shades, one each for top and bottom windows.

# Skylight Accessories

## Home Automation

### VELUX ACTIVE

Includes Climate Sensor, Departure Switch, and Internet Gateway

Model	Price	Delivery
KIX 300 US	—	S



### VELUX App Control

Control your VELUX skylights and shades anytime, anywhere with your smartphone or smart home device.

Model	Price	Delivery
KIG 300 US	—	S



### VELUX ACTIVE Indoor Climate Sensor

Additional sensor for other rooms with VELUX skylights

Model	Price	Delivery
KLA 300 US	—	S



### Home Automation Integration Kit

Wirelessly control up to five groups of solar/electric-powered skylights or shades

Model	Price	Delivery
KLF 200 US	—	S



### VELUX ACTIVE Departure Switch

Additional departure switch

Model	Price	Delivery
KLN 300 US	—	S



## Installation Accessories

### Additional Step Flashing Deck/Curb

Deck-mounted = 14 pieces - ZZZ 200 0000  
Curb-mounted = 12 pieces - ZZZ 200 0000C

Model	Price	Delivery
ZZZ 200 0000	—	S
ZZZ 200 0000C	—	S

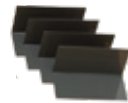

### Trim Groove Filler Kit

Three 57 1/2" pieces. One kit will work for most sizes

Model	Price	Delivery
ZZZ 213B	—	S



### Adhesive Underlayment

9" x 26' per roll

Model	Price	Delivery
ZOZ 216L	—	S

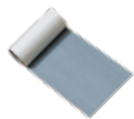

### Replacement Kit

4 pre-cut drywall groove filler pieces and 4 structural brackets. Use in deck-mounted applications Sizes: C01, C04, C06, C08, D06, D26, M02, M04, M06, M08, S01, S06

Model	Price	Delivery
ZZZ 238 + size	—	S

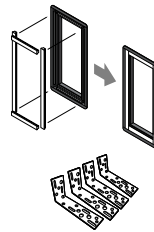

### Sun Screen Adapter Kit

Allows skylight models manufactured prior to January 1, 2010 to have special order shades. V-venting, F-fixed

Model	Price	Delivery
ZZZ 232V	—	T
ZZZ 232F	—	T

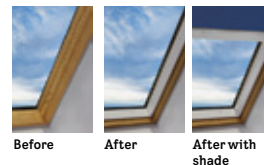

### Structural Brackets 4 brackets

Use in deck-mounted applications with an oversized rough opening

Model	Price	Delivery
ZZZ 219	—	T



### Wildfire Screen

Made to meet California's strictest fire codes for new skylight installations, these screens are compatible with all our Deck-Mounted and Curb-Mounted skylights.

Model	Price	Delivery
ZZZ 256 + size	—	F



## Remotes & Electric

### Basic Remote Control

Remote control allows users to operate single skylights or shades from anywhere in the room

Model	Price	Delivery
KLI 310 US	—	S



### VELUX Touch Remote Control

Remote control allows users to operate multiple skylights and shades with one remote from anywhere in the room, not dependent on Wi-Fi

Model	Price	Delivery
KLR 300 WW	—	S



## Manual Controls

### VS/VCM Crank Handle

Operate in-reach manual venting skylight

Model	Price	Delivery
ZZZ 201 (VS)	—	S
ZZZ 212 (VCM)*	—	S

\*Includes the ZZZ 208 extension.



### VS/VCM Replacement Hook

Replacement hook for out-of-reach manual venting skylight

Model	Price	Delivery
ZZZ 202 (VS)	—	S
ZZZ 211 (VCM)	—	S



### Extension Chain Operator

Extension for manual crank handle or manual angle adaptor to make skylights easier to operate

Model	Price	Delivery
ZZZ 208	—	S



### Angle Adaptor for Chain Operator

Used in conjunction with the manual hook for out-of-reach applications to make the skylight easier to operate with a manual pole

Model	Price	Delivery
ZZZ 203	—	S



### Battery Backup

Provides limited operation of VSE, VCE skylights and during power outages

Model	Price	Delivery
KLB 100 WW	—	S



### Telescopic Rod 6'-10' Manual Skylights

For VS and VCM skylights from 1982 to present and sun screen accessories made prior to 2010

Model	Price	Delivery
ZCT 300	—	S



### Telescopic Rod 3'-6' Manual Shades

For operation of manual sun screen accessories

Model	Price	Delivery
ZXT 200	—	S



### Universal Extension 3'

Extension piece for telescopic rods. Extends control rods for an additional 3'

Model	Price	Delivery
ZCT 100	—	S



# Sun Tunnel® Skylight Accessories

## Lighting

### Solar Night Light

Provides low level light available for rigid tube only

Model	Price	Delivery
ZTZ 213	—	S

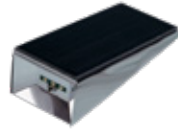

### Daylight Controller

Motorized variable positioning daylight control device. Requires ZZZ 233 Power Supply

Model	10"	14"	Delivery
ZTP	N/A	—	F



### Power Supply

Power supply for control devices

Model	Price	Delivery
ZZZ 233	—	F



### Universal Electric Light Kit

Designed to let Sun Tunnel® be a source of light at night and during the day

Model	10"	14"	22"	Delivery
ZTL 114	—	—	N/A	S
ZTL 122	N/A	N/A	—	S



### Discontinued – While Supplies Last

### Diffusion Enhancer - 6" band

Highly reflective obscure 6" band designed to diffuse direct sunlight

Model	10"	22"	Delivery
ZTZ 209	—	—	S



## Tube

### Rotation Coupler

Enables quick tube connections when getting around obstacles in the attic is required

Model	10"	14"	Delivery
ZTZ 211	—	—	S



### Elbows

Can be used at bottom, middle, or top of your installation - can form a 90 degree bend using multiple elbows with rotating couplers

Model	10"	14"	22"	Delivery
ZTE 0000	—	—	—	S



### Rigid Tube 24" reflective tunnel sections

Available in bulk quantities

Model	10"	14"	22"	Delivery
ZTR 2' - 1 unit	—	—	—	S
ZTR 4' - 2 units	—	—	—	S
ZTR 6' - 3 units	—	—	—	S
ZTR 12' - 6 units	—	—	—	S
ZTR 24' - 12 units	—	—	—	S



### Suspension Wire Kit

12-gauge wire and fastener set to secure longer tube sections

Model	Price	Delivery
ZTZ 203	—	F



## Performance Enhancing

### Energy Kit

Designed to increase energy efficiency; includes a thermal plate and a diffusing disc

Model	10"	14"	22"	Delivery
ZTC 0051US	—	—	N/A	S
ZTC 0041US	N/A	N/A	—	S



### Exterior Fire Band

Designed to meet fire prevention requirements of building codes - not available for TSR 10"

Model	10"	14"	22"	Delivery
ZZZ 192	—	—	—	F



### Vapor Barrier

Designed for protecting flashing components and ceiling opening from condensation

Model	10"	14"	22"	Delivery
ZTY	—	—	—	T



### Decorative Diffusers

Simple way to enhance your ceiling and ensure that your diffuser film matches the décor and feel of the room

Model	Description	10"	14"	Delivery
ZTB 4004US	Micro Fresnel	—	—	S
ZTB 4005US	Triple Wave	—	—	S
ZTB 4006US	Brushed Metal	—	—	S
ZTB 4007US	Prismatic	—	—	S
ZTB 4008US	Bubbles	—	—	S
ZTB 4009US	Neutral light	—	—	S



## Flashing

### Curb-Mounted Flashing - Tile

Install on tile roofing material over 3/4" thickness for roof pitch 14-60° for TCR and TZR models

Sun Tunnel	Flashing Model	14"	Delivery
TCR	ECW 014 0000	—	S
TZR	ECW 014Z 0000	—	F



### Sun Tunnel® Flashing - Tile

Water-tight flashing without the use of sealants Only for TMR and TMF

Model	10"	14"	Delivery
ZTM 0000 50	—	—	F





# Roof Windows

## Top-Hinged GPU



45° GPU Top-hinged Roof Window

GPU Roof Pitch  
15° - 55°  
3:12 - 17:12

- Designed for in-reach applications, such as bonus rooms or attics.
- **Stocked GPU Units are for Roofs with a Maximum of 55° Roof Pitch.** Roofs with a pitch greater than 55° need to order GPU units with special springs for an additional cost per unit.

Opens to a maximum of 45° to satisfy egress requirements for emergency escape.  
(MK06, MK08, PK10, SK06, UK08 meet egress requirements. CK04, CK06, MK04 do not meet egress requirements.)

Special order shade options  
See page 43



Standard Sizes (W-in. x H-in.)	CK04	CK06	MK04	MK06	MK08	PK10	SK06	UK08
Outside Frame	21 5/8 x 38 1/2	21 5/8 x 46 3/8	30 3/4 x 38 1/2	30 3/4 x 46 3/8	30 3/4 x 55	37 1/8 x 63	44 7/8 x 46 3/8	52 3/4 x 55 1/16
Rough Opening	22 1/8 x 39	22 1/8 x 46 7/8	31 1/4 x 39	31 1/4 x 46 7/8	31 1/4 x 55 1/2	37 5/8 x 63 1/2	45 3/8 x 46 7/8	53 1/4 x 55 1/2

Base Model	CK04	CK06	MK04	MK06	MK08	PK10	SK06	UK08
Laminated Glass Code 0070   Delivery T	-	-	-	-	-	-	-	-

Flashing	CK04	CK06	MK04	MK06	MK08	PK10	SK06	UK08
Step Flashing Asphalt Shingles, Wood Shakes, or Slate Up to 1/2 inch maximum thickness Code EDL   Delivery T	-	-	-	-	-	-	-	-
High Profile Flashing Tile - Over 3/4 inch thickness Code EDW   Delivery T	-	-	-	-	-	-	-	-

All cladding components for roof windows are included in the flashing box. If VELUX flashing is not used, then ZWC cladding pieces must be ordered. Call Customer Service for pricing on Flashing Kits available for when replacing old Roof Windows with new Roof Windows.

Accessories	CK04	CK06	MK04	MK06	MK08	PK10	SK06	UK08
Manual Shade White, Room-Darkening, Double-Pleated Code FHC 1045SWL   Delivery T					-			
Manual Shade White, Light-Filtering, Single-Pleated Code FHL 1016SWL   Delivery T					-			
Manual Shade White Venetian Code PAL 7001SWL   Delivery T					-			
Insect Screen Code ZIL 0000SWL   Delivery T					-			

# Roof Windows

## Roof Access GXU

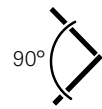

**GXU** Roof Access  
Roof Window



GXU Roof Pitch

- Opens 90° for easy access to the outdoors.
- Designed for in-reach applications.



FK06 satisfies egress requirements for emergency escape.  
(CK06 size does not meet requirements for emergency escape.)



Special order shade options  
See page 43



Standard Sizes (W-in. x H-in.)	CK06	FK06
Outside Frame	21 5/8 x 46 3/8	26 x 46 3/8
Rough Opening	22 1/8 x 46 7/8	26 1/2 x 46 7/8

Base Model	CK06	FK06
Laminated Glass Code 0070   Delivery T	-	-

Flashing	CK06	FK06
Step Flashing Asphalt Shingles, Wood Shakes, or Slate Up to 1/2 inch maximum thickness Code EDL   Delivery T	-	-
High Profile Flashing Tile - Over 3/4 inch thickness Code EDW   Delivery T	-	-

All cladding components for roof windows are included in the flashing box. If VELUX flashing is not used, then ZWC cladding pieces must be ordered.

Accessories	CK06	FK06
Manual Shade White, Room-Darkening, Double-Pleated Code FHC 1045SWL   Delivery T	-	-
Manual Shade White, Light-Filtering, Single-Pleated Code FHL 1016SWL   Delivery T	-	-
Manual Shade White Venetian Code PAL 7001SWL   Delivery T	-	-
Insect Screen Code ZIL 0000SWL   Delivery T	-	-

# Roof Windows

## Balcony GDL



GDL Balcony Roof Window



GDL Balcony Roof Pitch

- Dual-sash operation: top opens for ventilation and bottom opens outward to create a roof balcony.
- When the GDL Balcony Roof Window is closed, a ventilation flap can be opened to provide a breath of fresh air, even if it is raining outside.
- For in-reach application only.



Standard Sizes	MK19	PK19
(W-in. x H-in.)		
Outside Frame	30 3/4 x 99 1/4	37 1/16 x 99 1/4
Rough Opening	33 1/16 x 101	39 3/8 x 101

Base Model	MK19	PK19
Laminated Glass/Aluminum Code 3066   Delivery T	-	-

Flashing	MK19	PK19
Step Flashing Asphalt Shingles, Wood Shakes, or Slate Up to 1/2 inch maximum thickness Code EDL   Delivery T	-	-
High Profile Flashing Tile - Over 3/4 inch thickness Code EDW   Delivery T	-	-

Accessories	MK19	PK19
Manual Shade White, Room-Darkening, Double-Pleated Code FHC SD1045SWL   Delivery T	-	-
Manual Shade White, Light-Filtering, Single-Pleated Code FHL SD1016SWL   Delivery T	-	-
Insect Screen Three parts are required for each Balcony Roof Window Code ZOZ 157SWL   Delivery T	-	-
Code ZIL MK06 0000SWLG   Delivery T	-	-
Code ZIL MK10 0000SWL   Delivery T	-	N/A
Code ZIL PK06 0000SWL   Delivery T	N/A	-
Code ZIL PK10 0000SWL   Delivery T	N/A	-

# Roof Windows

## Center-Pivot GGU



**GGU Center-Pivot**  
Roof Window



GGU Roof Pitch

- Easy to open and quick to close with the top control bar.
- For in-reach application only.



Special order shade options  
See page 43



Standard Sizes	CK02	CK04	CK06	FK04	FK06	FK08	MK04	MK06	MK08	MK10	PK06	PK08	PK10	SK06	SK08	UK04	UK08
(W-in. x H-in.)																	

Outside Frame	21 <sup>5</sup> / <sub>8</sub> x 30 <sup>5</sup> / <sub>8</sub>	21 <sup>5</sup> / <sub>8</sub> x 38 <sup>1</sup> / <sub>2</sub>	21 <sup>5</sup> / <sub>8</sub> x 46 <sup>3</sup> / <sub>8</sub>	26x 38 <sup>1</sup> / <sub>2</sub>	26x 46 <sup>3</sup> / <sub>8</sub>	26x 55	30 <sup>3</sup> / <sub>4</sub> x 38 <sup>1</sup> / <sub>2</sub>	30 <sup>3</sup> / <sub>4</sub> x 46 <sup>3</sup> / <sub>8</sub>	30 <sup>3</sup> / <sub>4</sub> x 55	30 <sup>3</sup> / <sub>4</sub> x 63	37 <sup>1</sup> / <sub>8</sub> x 46 <sup>3</sup> / <sub>8</sub>	37 <sup>1</sup> / <sub>8</sub> x 55	37 <sup>1</sup> / <sub>8</sub> x 63	44 <sup>7</sup> / <sub>8</sub> x 46 <sup>3</sup> / <sub>8</sub>	44 <sup>7</sup> / <sub>8</sub> x 55	52 <sup>3</sup> / <sub>4</sub> x 38 <sup>1</sup> / <sub>2</sub>	52 <sup>3</sup> / <sub>4</sub> x 55 <sup>1</sup> / <sub>16</sub>
Rough Opening	22 <sup>1</sup> / <sub>8</sub> x 31 <sup>1</sup> / <sub>8</sub>	22 <sup>1</sup> / <sub>8</sub> x 39	22 <sup>1</sup> / <sub>8</sub> x 46 <sup>7</sup> / <sub>8</sub>	26 <sup>1</sup> / <sub>2</sub> x 39	26 <sup>1</sup> / <sub>2</sub> x 46 <sup>7</sup> / <sub>8</sub>	26 <sup>1</sup> / <sub>2</sub> x 55 <sup>1</sup> / <sub>2</sub>	31 <sup>1</sup> / <sub>4</sub> x 39	31 <sup>1</sup> / <sub>4</sub> x 46 <sup>7</sup> / <sub>8</sub>	31 <sup>1</sup> / <sub>4</sub> x 55 <sup>1</sup> / <sub>2</sub>	31 <sup>1</sup> / <sub>4</sub> x 63 <sup>1</sup> / <sub>2</sub>	37 <sup>5</sup> / <sub>8</sub> x 46 <sup>7</sup> / <sub>8</sub>	37 <sup>5</sup> / <sub>8</sub> x 55 <sup>1</sup> / <sub>2</sub>	37 <sup>5</sup> / <sub>8</sub> x 63 <sup>1</sup> / <sub>2</sub>	45 <sup>3</sup> / <sub>8</sub> x 46 <sup>7</sup> / <sub>8</sub>	45 <sup>3</sup> / <sub>8</sub> x 55 <sup>1</sup> / <sub>2</sub>	53 <sup>1</sup> / <sub>4</sub> x 39	53 <sup>1</sup> / <sub>4</sub> x 55 <sup>1</sup> / <sub>2</sub>

Base Model	CK02	CK04	CK06	FK04	FK06	FK08	MK04	MK06	MK08	MK10	PK06	PK08	PK10	SK06	SK08	UK04	UK08
Laminated Glass Code 0070   Delivery N	-	-	-	-	-	-	-	-	-	-	-	-	-	-	-	-	-

Flashing	CK02	CK04	CK06	FK04	FK06	FK08	MK04	MK06	MK08	MK10	PK06	PK08	PK10	SK06	SK08	UK04	UK08
Step Flashing Code EDL   Delivery T	-	-	-	-	-	-	-	-	-	-	-	-	-	-	-	-	-
High Profile Flashing Code EDW   Delivery T	-	-	-	-	-	-	-	-	-	-	-	-	-	-	-	-	-

All cladding components for roof windows are included in the flashing box. If VELUX flashing is not used, then ZWC cladding pieces must be ordered. Call Customer Service for pricing on Flashing Kits available for when replacing old Roof Windows with new Roof Windows.

Accessories	CK02	CK04	CK06	FK04	FK06	FK08	MK04	MK06	MK08	MK10	PK06	PK08	PK10	SK06	SK08	UK04	UK08
Manual Shade White, Room Darkening, Double-Pleated Code FHC 1045SWL   Delivery T	-N	-	-	-N	-	-	-N	-	-	-	-N	-N	-	-	-N	-	-
Manual Shade White, Light-Filtering, Single-Pleated Code FHL 1016SWL   Delivery T	-N	-	-	-N	-	-	-N	-	-	-N	-N	-N	-	-	-N	-	-
Manual Shade White Venetian Code PAL 7001SWL   Delivery T	-	-	-	-	-	-	-	-	-	-	-	-	-	-	-	-	-
Insect Screen Code ZIL 0000SWL   Delivery T	-	-	-	-N	-	-	-N	-	-	-N	-N	-N	-	-	-N	-	-

# Architectural Skylights

## Custom Skylight Systems

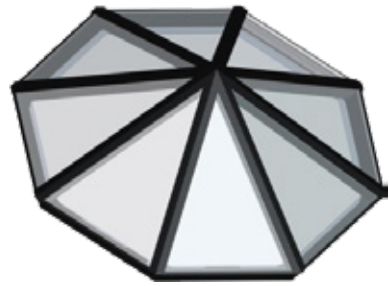

- Unlimited design capabilities to create spectacular daylighting applications.
- Capable of spanning up to 40 feet.
- Broad range of glass options to select from, including hurricane-rated, electrochromic, photovoltaic, and insulated glass, or cellular polycarbonate with option for aerogel fill.
- Available in standard or custom sizes, both with reliable engineering, construction, and installation.
- Choose from a broad range of interior and exterior finishes.

Custom Finish Colors:

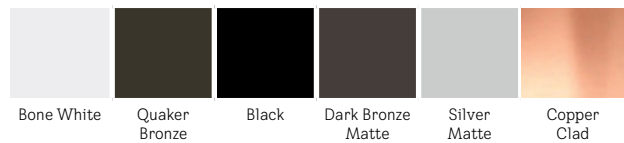

Mill finish standard. Other custom finish colors are available. Visit [commercial.veluxusa.com/products/finishes](http://commercial.veluxusa.com/products/finishes) for full list of finish colors.



### Pinnacle System

- Spans up to 40' wide, unlimited length
- Self-supporting structural system
- Custom skylight pitches 15° - 60°
- Flat or pitched roof applications
- Custom glazing options
- Custom finish colors
- Site-built system



Square Pyramid



Polygonal Pyramid



Extended Pyramid

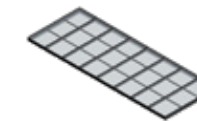

Single Pitch

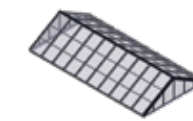

Double Pitch



Structural Ridge

### Classic System

- Spans up to 6' wide, unlimited length
- Self-supporting structural system
- Three standard skylight pitches: 5:12, 7:12, 12:12
- Flat or pitched roof applications
- Custom glazing options
- Custom finish colors
- Factory welded and assembled



Square Pyramid



Polygonal Pyramid

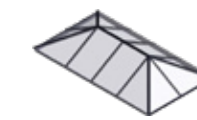

Extended Pyramid

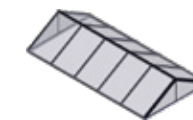

Double Pitch

### Low Profile System

- Unlimited width and length
- Structural support required
- Pitched roof applications
- Custom glazing options
- Custom finish colors
- Factory-built or site-built system

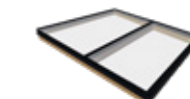

Low Profile

# Architectural Skylights

## VELUX Modular Skylights – VMS



VMS Roof Pitch  
0°-90°

- Pre-glazed module with 100% prefabricated components and unique bracket system guarantees a predictable installation process
- Watertight design ensures moisture protection without need for sealants
- Hidden chain actuators allow modules to vent allowing fresh air into the building
- Internal shades can be pre-installed allowing for shading throughout the day
- Velux Modular Skylight systems available for roof pitches between 0°-90°
- Email [commercialestimating.us@velux.com](mailto:commercialestimating.us@velux.com) for details

The installer is responsible for curb-flashing material and installation of the curb to the roof.



The unique bracket system that makes every single module fit every solution

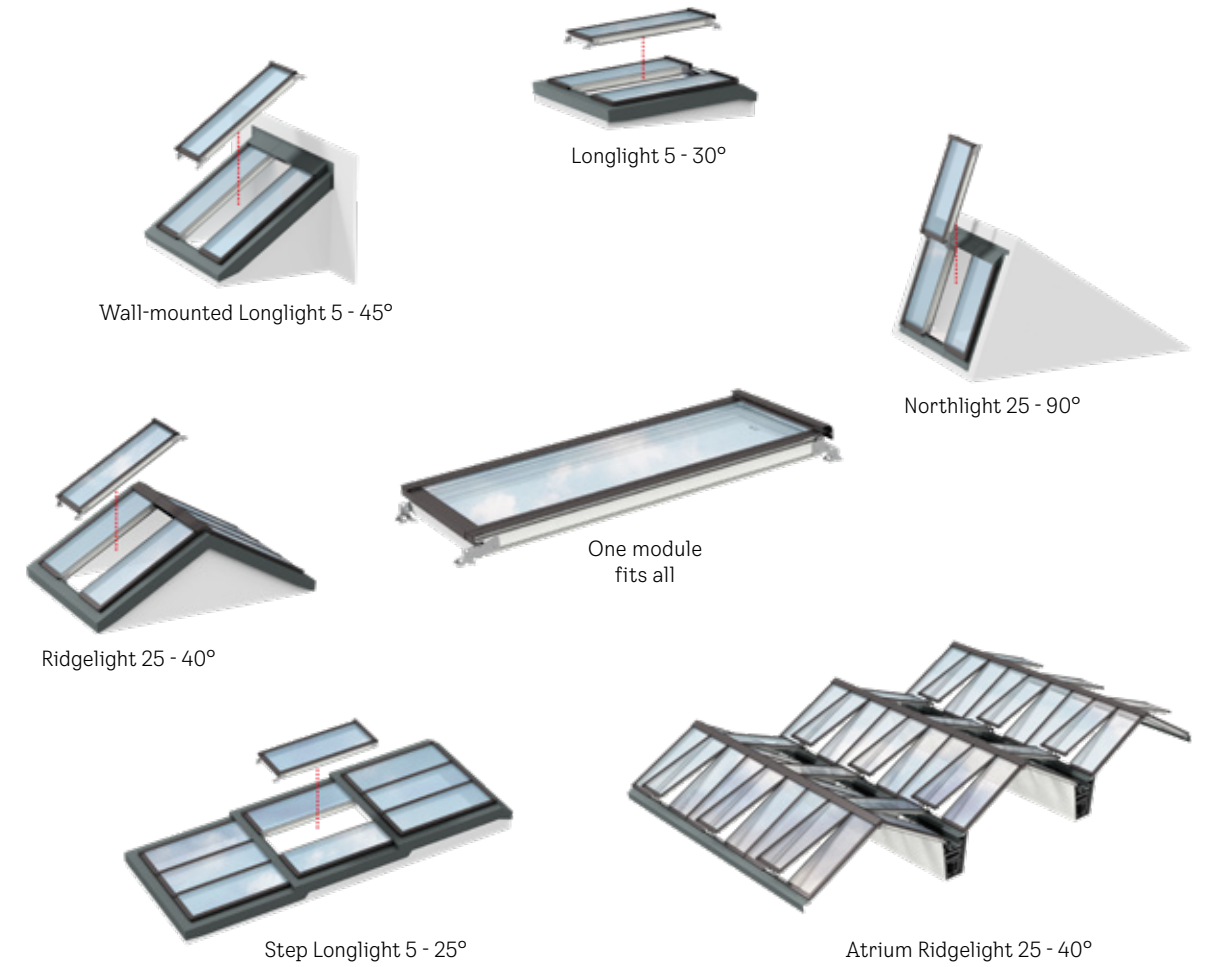

VMS modules can be equipped with electrically-operated roller shades

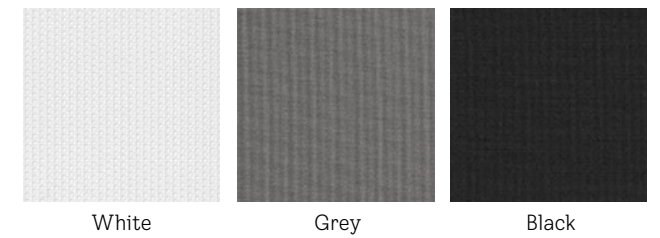

Delivery time approximately 10-15 weeks for product and shades.

Transforming spaces since 1941. For over 80 years, VELUX has helped people envision and achieve the transformation of spaces using daylight and fresh air through the roof. Our product program includes skylights, Sun Tunnel® skylights, decorative shades and roof windows, as well as installation and smart home solutions. By creating brighter, healthier, more sustainable places to live, work, learn, and play we enable a better everyday life for people around the world. We work globally with sales and manufacturing operations in more than 40 countries and around 11,500 employees worldwide. The VELUX Group is owned by VKR Holding A/S, a limited company wholly owned by non-profit, charitable foundations (THE VELUX FOUNDATIONS) and family.

For more information, visit [veluxusa.com](http://veluxusa.com).

VELUX America LLC  
215 Puckett Ferry Road  
PO Box 5001  
Greenwood, SC 29648-5001

1-800-888-3589

[veluxusa.com](http://veluxusa.com)  
[whyskylights.com](http://whyskylights.com)