

THE POWER OF

**REDARC**®

# In-vehicle 3-Stage 24V Battery Charger

**BCDC2410**

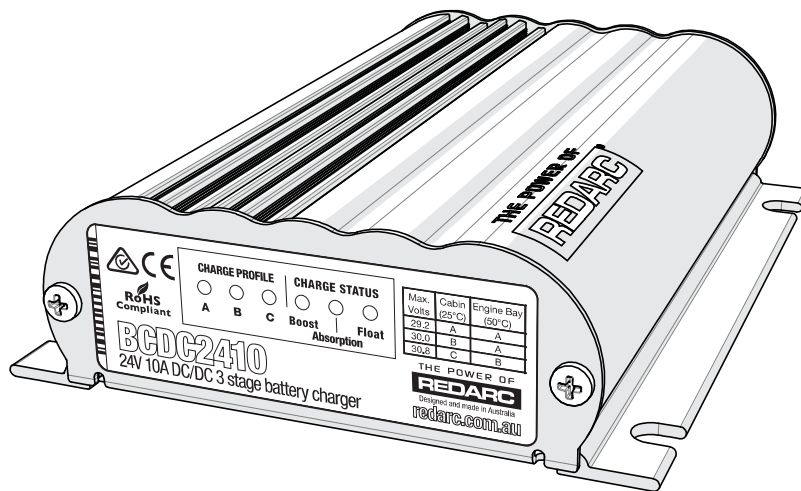

## THE BCDC2410

---

The BCDC2410 In-vehicle Battery Chargers feature technology designed to charge your lead-acid batteries to 100%, regardless of their type or size. By providing a unique charging profile to each specific battery type, the BCDC2410 In-Vehicle Battery Chargers are able to achieve and maintain an optimal charge in your auxiliary battery, at all times.

The BCDC24210 In-vehicle Battery Chargers also feature a Maximum Power Point Tracking (MPPT) solar regulator, allowing you to deliver the maximum amount of power from your solar panels to your auxiliary battery.

The BCDC2410 is designed to work with either fixed voltage or temperature compensating alternators.

## WARNING & SAFETY INSTRUCTIONS

---

**SAVE THESE INSTRUCTIONS** - This manual contains **IMPORTANT SAFETY INSTRUCTIONS** for the BCDC2410 battery chargers.

**DO NOT OPERATE THE BATTERY CHARGER UNLESS YOU HAVE READ AND UNDERSTOOD THIS MANUAL AND THE CHARGER IS INSTALLED AS PER THESE INSTALLATION INSTRUCTIONS.**

### **⚠ WARNING**

**RISK OF EXPLOSIVE GASES:**

**WORKING IN VICINITY OF A LEAD-ACID BATTERY IS DANGEROUS. BATTERIES GENERATE EXPLOSIVE GASES DURING NORMAL OPERATION. FOR THIS REASON, IT IS OF UTMOST IMPORTANCE THAT YOU FOLLOW THE INSTRUCTIONS WHEN INSTALLING AND USING THE CHARGER.**

### **⚠ CAUTION**

1. The Battery Charger should not be used by persons (including children) with reduced physical, sensory or mental capabilities, or lack of experience and knowledge, unless they are supervised or have been instructed on how to use the appliance by a person responsible for their safety. Children should be supervised to ensure that they do not play with the Battery Charger.
2. Do NOT alter or disassemble the Battery Charger under any circumstances. All faulty units must be returned to REDARC for repair. Incorrect handling or reassembly may result in a risk of electric shock or fire and may void the unit warranty.
3. Only use the Battery Charger for charging Standard Automotive Lead Acid, Calcium Content, Gel, AGM or Deep Cycle type 12V batteries. Check the manufacturers data for your battery and ensure that the 'Maximum' voltage of the profile you select does not exceed the manufacturers recommended maximum charging voltage. If the 'Maximum' voltage for your battery type is too high, please select another charging profile. The Battery Charger is not intended to supply power to a low voltage electrical system other than to charge a battery.
4. NEVER smoke or allow a spark or flame in vicinity of battery or engine. This may cause the battery to explode.
5. **PERSONAL SAFETY PRECAUTIONS**  
To assist with the safe operation and use of the Battery Charger:
  - a) Wear complete eye protection and clothing protection. Avoid touching eyes while working near a battery.
  - b) If battery acid contacts your skin or clothing, remove the affected clothing and wash the affected area of your skin immediately with soap and water. If battery acid enters your eye, immediately flood the eye with running cold water for at least 10 minutes and seek medical assistance immediately.

## CONTENTS

Table of Contents	Page
Warnings and Safety Instructions	01
Contents	02
Specifications	02
1 Product Function	03
1. Display Panel	03
2. Charging Algorithm	04
3. Turn On/Off Thresholds	04
4. Error Codes	05
2 Installation	05
1. RED wire - Input Source Positive	05
2. BLUE wire - Source Select	06
3. ORANGE wire - Charging Profile Select	07
4. BROWN wire - Auxiliary Battery Positive	08
5. BLACK wire - Common Ground	08
6. GREEN wire - Optional External LED Indication	08
7. Cable Sizing	09
8. Wiring	09
9. Fusing	12
3 Troubleshooting	12
4 Frequently Asked Questions	13
5 Two Year Warranty	14

## Specifications

Part Number	BCDC2410		
Continuous Current Rating	10A		
Input Fuse Rating 12V/24V	30A/20A (Not supplied)		
Output Fuse Rating	15A (Not supplied)		
Output Power	300W		
DC Input Voltage Range	9-32V		
Solar Panel Open Circuit Voltage	17.5V-28.0V		
Output Battery Type	Standard Lead Acid, Calcium content, Gel & AGM type only		
Charging Profile	A	B	C
- Maximum Voltage <i>(refer to section 2.3)</i>	29.2	30.0	30.6
- Float Voltage	26.6V		
No Load Current	<100mA		
Standby Current	<8mA		
Ambient Temperature	-20°C to +80°C		
Minimum O/P Battery Volts	4.2V		
Weight	680g		
Dimensions	150x120x37mm		
Warranty	2 years		
Standards	CE, C-Tick, AS/NZS CISPR11:2004		

# 1 PRODUCT FUNCTION

The BCDC2410 is a three-stage, 24V DC-DC battery charger that operates from an alternator input of 12V nominal or a 12V nominal solar panel input. The BCDC2410 will also charge from an alternator input from a 24V nominal vehicle\*1. The input voltage of the BCDC2410 can be above, below or equal to the output voltage making it ideal for charging an auxiliary 24V battery bank where the distance from the main battery may cause a significant voltage drop. The BCDC2410 is also designed to isolate the main battery from the auxiliary battery to avoid over-discharging the main battery.

## 1.1 Display Panel

The front panel features 6 LEDs to display the charge profile and charge status.

LED State	'Charge Profile' LED	'Charge Status' LED
Off	Unit has no Power	Output is off
Blinking	Unit is in Standby	Unit is supplying power
On	Unit is on and can supply power	

When blinking, the flash duty-cycle of the 'Charge Status' LED will increase to reflect the amount of current being supplied - If the LED is ON solid, the unit is supplying full power (i.e. 10A for the BCDC2410).

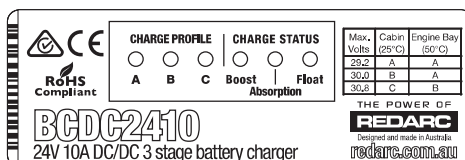

Figure 1.6.1 - The BCDC2410 Front Panel

# 1 PRODUCT FUNCTION

---

## 1.2 Charging Algorithm

When the BCDC2410 is turned on, it will move into the *Boost* stage. The Boost stage maintains a constant current until the battery voltage reaches the Absorption Voltage. The current during Boost stage may vary throughout operation in order to maintain a safe operating temperature, or to limit the difference between input and output voltages.

The charger will then move to *Absorption* stage which maintains a constant voltage level for a predetermined period of time or until the current being drawn by the output battery drops to less than 4A for 30 seconds; after which the charger will enter *Float* stage.

*Float* stage maintains 13.3V on the output battery, keeping the battery topped up. This counteracts the battery's self discharging or loads applied to the battery. When the battery loses charge, the charger will move back into the *Boost* stage.

## 1.3 Turn On/Off Thresholds

Input Voltage		12V	Solar	24V
Input Open Circuit Low voltage conditions *1	Turn ON above	13.2V	17.5V	26.4V
	Turn OFF below	12.7V	17.2V	25.4V
Input Loaded Low voltage conditions*2	Turn OFF instantly below	8V		17V
	Turn OFF after 20 secs below	9V	N/A	18V
Input Over voltage shutdown	Turn ON below	15.5V	28V	32V
	Turn OFF instantly above	16V	29V	32.5V
	Turn OFF after 20 secs above	15.6V	28.2V	32.1V
Output Under voltage shutdown	Shutdown if Output Battery < 4V			

\*1 Tested every 100 Seconds.

\*2 Constantly tested.

# 1 PRODUCT FUNCTION

---

## 1.4 Error Codes

In the event of a fault with the unit installation, either battery or solar panel, ALL the LEDs on the unit will flash to indicate the fault type. Flashing sequences are described in the table below.

LED State	Description
1 flash (1 flash followed by 3.5 second off)	Internal Hardware Fault
2 flash (2 flash followed by 3.5 second off)	Reserved
3 flash (3 flash followed by 3.5 second off)	Unit over temp fault
4 flash (4 flash followed by 3.5 second off)	Output Battery Fault (Volts too high) / Solar Panel connected reverse polarity
5 flash (5 flash followed by 3.5 second off)	Input under voltage (Battery)
6 flash (6 flash followed by 3.5 second off)	Input over voltage (Battery or Solar panel)
7 flash (7 flash followed by 3.5 second off)	Reverse polarity

NOTE: The unit will operate optimally below 55°C with good airflow. At higher temperatures the unit will de-rate output current.

NOTE: Appropriate connections must be made to the wires with a continuous current rating of at least 10A for the BCDC2410. Failure to do so may cause damage to the unit and vehicle.

## 2 INSTALLATION

---

Mount the unit to a flat surface close to the auxiliary battery and away from any heat sources. The BCDC2410 has 6 wires and should be installed as described over the following pages.

### 2.1 RED wire - Input Source Positive

The RED wire should be connected to the positive input from the source - this can be either from a vehicle's starter battery or from a solar panel.

Appropriate size fuses should be used as per the specifications table on page 2.



--- OR ---

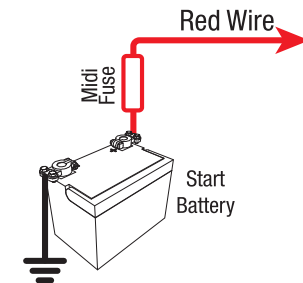

## 2 INSTALLATION

### 2.2 BLUE wire - Source Select

The BLUE wire is provided to select whether the unit is charging from a vehicle input or from a solar panel. This wire is monitored at all times.

#### 2.1.1 Alternator Input

To charge from an alternator, the BLUE 'Source Select' wire must be connected to the vehicle ignition or to the Input Source Positive (RED).

When connected in this way, the charger will only charge the auxiliary battery when the vehicle ignition is ON, guaranteeing that the charger will not drain the input battery.

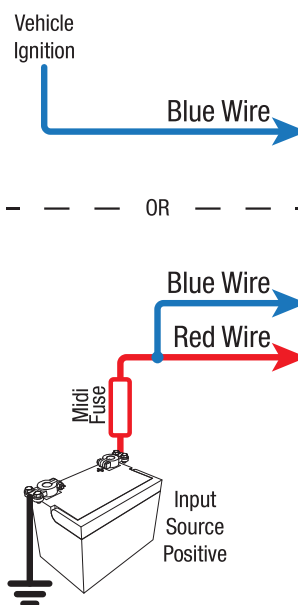

#### 2.1.2 Solar Input

The BCDC2410 is also capable of charging the auxiliary battery from a Solar source. The unit will accept an input directly from an unregulated 12V nominal solar panels and act as a MPPT Solar Regulator. To select the Solar charging mode, the BLUE 'Source Select' wire can either be left disconnected or connected to GROUND.

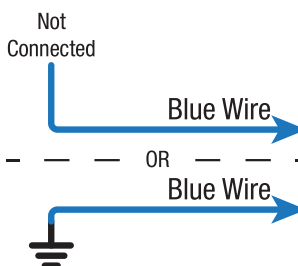

## 2 INSTALLATION

### 2.3 ORANGE wire - Battery Type Select

The ORANGE wire is used to select the *Maximum* output voltage. This is achieved by connecting in the following way:

To select **Profile A** leave the ORANGE wire disconnected. This will set the *Maximum* voltage to 29.2V.

To select **Profile B** connect the ORANGE wire to Common Ground. This will set the *Maximum* voltage to 30.0V.

To select **Profile C** connect the ORANGE wire to the RED wire (Input source positive). This will set the *Maximum* voltage to 30.8V.

#### ⚠ CAUTION

Check the manufacturer's data for your battery(s) and ensure that the *Maximum* voltage of the profile you select does not exceed the manufacturer's recommended maximum charging voltage. If the *Maximum* voltage for your battery type is too high, please select another charging profile.

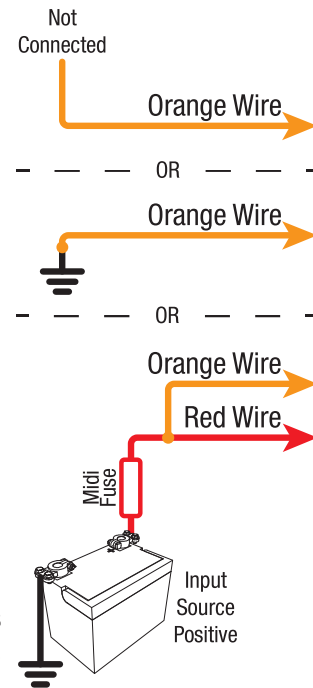

#### 2.3.1 ORANGE wire - Setting Recommendations

Battery Manufacturer's Maximum Battery Voltage Specification	Auxiliary Battery Location	
	Cabin Install	Engine Bay Install
29.2	A	A
30.0	B	A
30.8	C	B



## 2 INSTALLATION

---

### 2.4 BROWN wire - Auxiliary Battery Positive

The BROWN wire should be connected to the auxiliary battery's positive terminal. This should be a maximum of 1 metre in cable length from the battery. Appropriate size fuses should be used as per the specifications table on page 2.

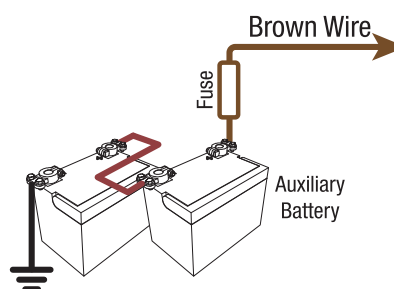

### 2.5 BLACK wire - Common Ground

The BLACK wire should be connected to a ground point that is common to both the Start battery (or the Solar Input Ground wire) and the Auxiliary battery to be charged. This point may be on the chassis of the vehicle, on the chassis of the trailer/camper/caravan or directly wired to both batteries, depending on your installation requirements.



### 2.6 GREEN wire - Optional External LED Indication

The GREEN wire is provided to optionally connect an external indicator LED which can be mounted away from the unit (for example on the vehicle's dashboard). Connect the positive lead of the LED to the green wire, and the negative lead to the common ground. No external resistors are required.

The External LED will be ON when the unit is charging and OFF when the unit is in standby mode or has no power. Note: This output is not suitable for running a globe.

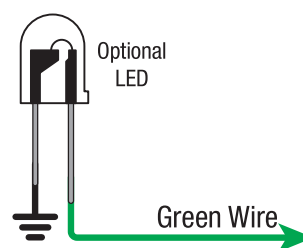

## 2 INSTALLATION

### 2.7 Cable sizing

Below is a table outlining the required cable size for a given cable install length. Always choose a wire diameter equal to or greater than what is specified below.

Cable Install Length (m)	Recommended Wire Size (mm <sup>2</sup> )	Closest (BAE, B&S, AWG)
1 - 3	3.5	6mm auto
3 - 5	5.7	8 B&S
5 - 9	10.2	8 B&S

### 2.8 Wiring

The heavy gauge wires on the BCDC2410 unit carry peak currents of up to 20 Amps, and it is important to make a good, low resistance, electrical connection that will not degrade over time. Failure to make a good, reliable contact may result in breakdown of the wire insulation and cause a short circuit, or worst case a fire. We recommend that this activity be undertaken by an appropriately trained person.

REDARC recommends using a soldered butt splice crimp connection that is covered with heatshrink. See Figure 2.8. REDARC does not recommend using standard red/ blue/yellow blade connections as they are not rated for either the current required or gauge of wire supplied on the unit.

Crimping provides good mechanical connection, soldering provides a long lasting electrical connection and forming of the heatshrink will prevent any shorting/contact with your vehicle chassis.

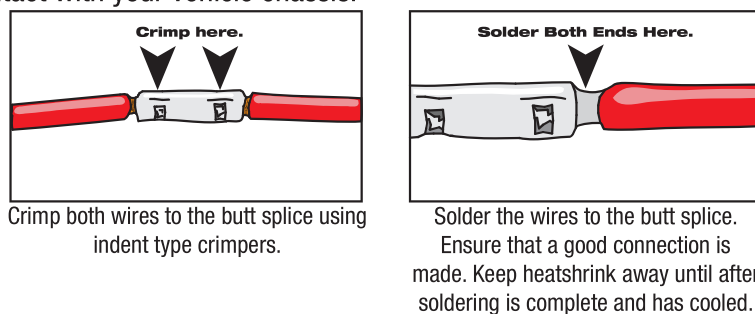

Figure 2.8 - Ensuring a good wiring connection

## 2 INSTALLATION

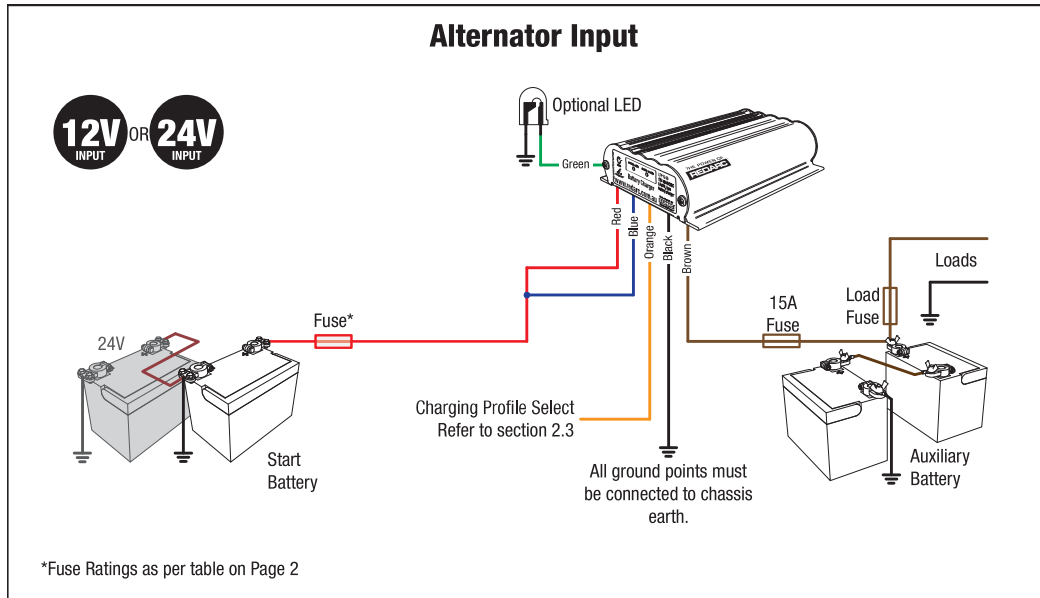

Figure 2.8a - Standard setup for input from a 12V or 24V Start Battery

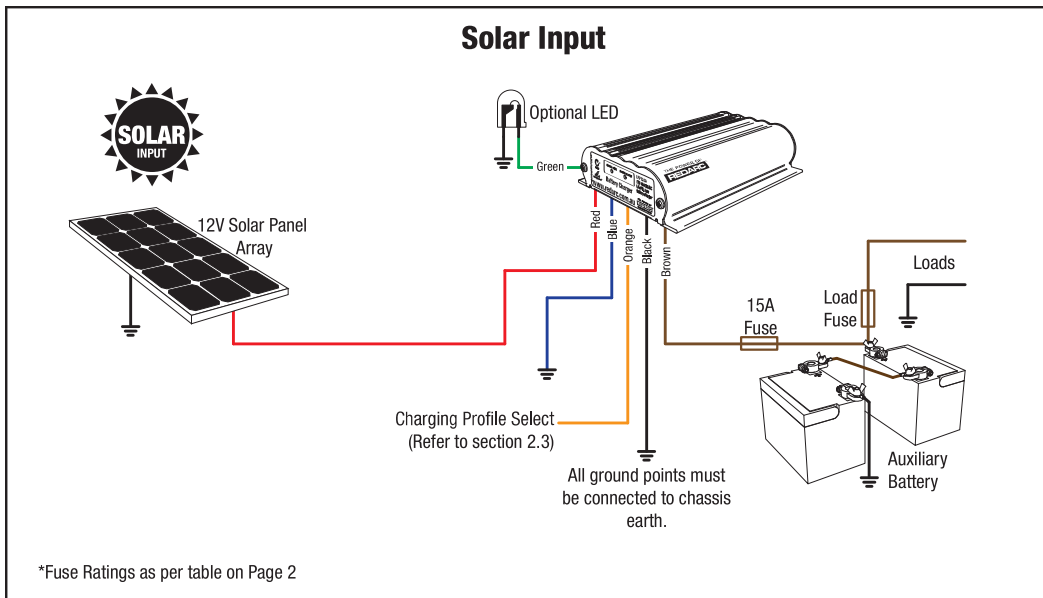

Figure 2.8b - Standard setup for input from a 12V Solar array

## 2 INSTALLATION

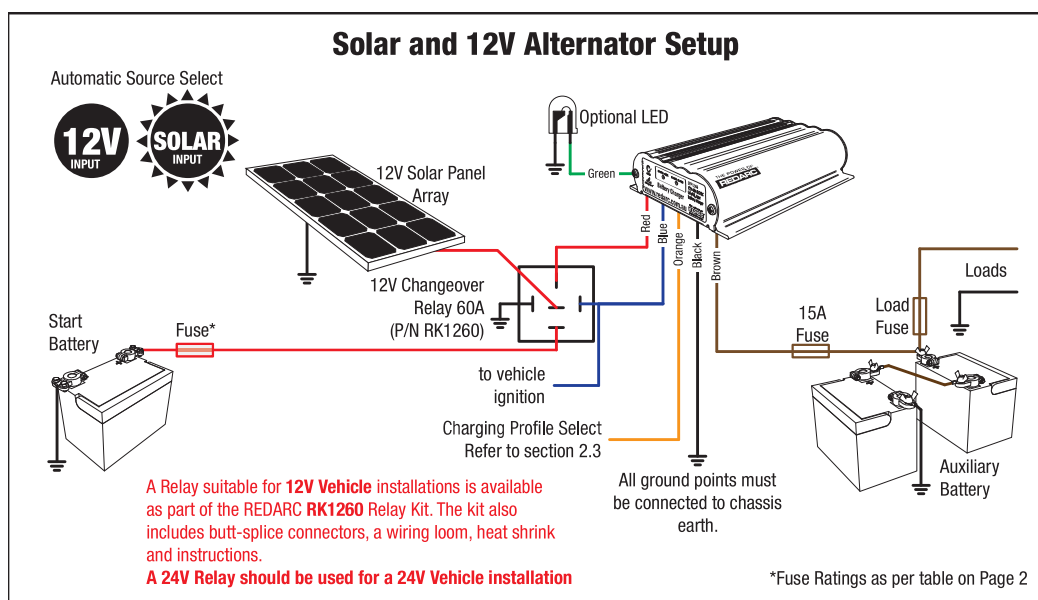

Figure 2.8c - Using a changeover relay for 12V Start Battery & 12V Solar array inputs

## 2 INSTALLATION

### 2.9 Fusing

REDARC recommend using MIDI style bolt down fuses as they ensure a low resistance connection.

Blade type fuses are not recommended as they can result in a high resistance connection which causes excess heat and may damage the fuse holder and/or the wiring. Self-resetting circuit breakers are not recommended as they may trip prematurely due to the heat generated by the current flowing through the wires.

## 3 TROUBLESHOOTING

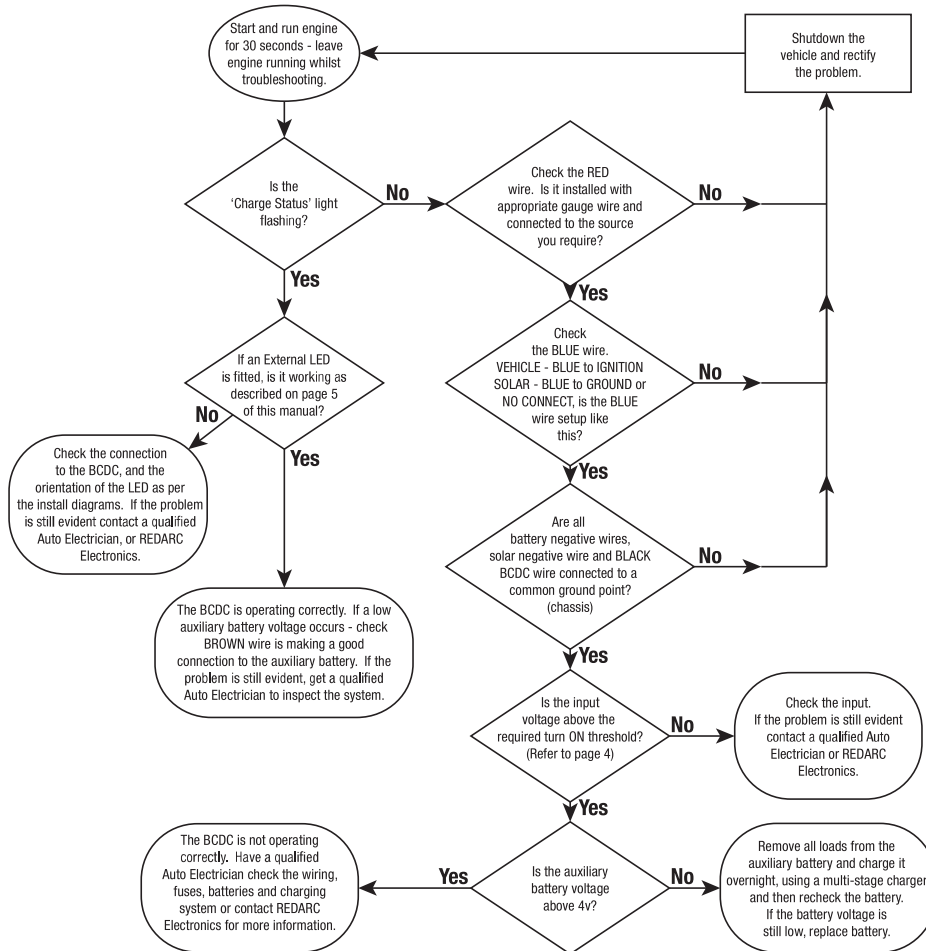

## **4 FREQUENTLY ASKED QUESTIONS**

---

**Q The BCDC2410 turns ON at 13.2V and OFF at 12.7V, but you say it operates down to 9V, explain?**

**A** The BCDC2410 will turn OFF for a split second every 100 seconds to measure the unloaded voltage at the battery. When the BCDC2410 turns off it is not drawing any load from the start battery, no load means that there is no voltage drop over the cable run. This allows the BCDC2410 to measure the actual battery voltage, or the voltage at the battery. If this actual battery voltage is below 12.7V, the BCDC2410 will turn OFF. At any other time during the charging process, if the voltage at the BCDC2410 drops below 9V the BCDC2410 will turn OFF.

**Q How does the BCDC charge an Auxiliary battery at 29V when it only gets 9V in?**

**A** The BCDC can act as both a reducer and a booster, so it can operate from a voltage of above, equal to or below the desired output voltage. The unit is also microprocessor controlled allowing it to output a Redarc proprietary charging algorithm independent of the input. This allows the unit to charge specific to the battery type even if the input voltage is low due to voltage drop.

**Q Where should I mount the BCDC Unit?**

**A** The BCDC should be mounted as close as possible to the battery being charged (generally called the Auxiliary or House battery). If the Auxiliary battery is located under the bonnet, pick a location for the BCDC that is close to the battery and away from any direct engine heat. If the BCDC is to be mounted into a Caravan or Camper, near or in the battery compartment is generally the best position. It is also a good idea to mount the BCDC to a metal surface if possible to ensure optimal heat dissipation, though this is not crucial.

**Q What does the charger do if the temperature around it rises above its operating temperature?**

**A** As the temperature of the BCDC rises above a certain level the current capacity of the output is decreased gradually in order to protect both the battery and the BCDC unit.

**Q If I use the BCDC to charge my auxiliary battery do I still need to install a battery isolator?**

**A** The BCDC incorporates the functionality of a battery isolator, it will turn ON and start charging when it senses that the vehicle has started and similarly it will turn OFF when the vehicle is turned OFF.

**Q I've heard that you shouldn't charge 2 batteries of different chemistries from the same source, will I have any problems charging my AGM or Gel auxiliary battery from my Lead Acid start battery?**

**A** The BCDC does not 'link' the batteries together like a battery isolator does, it is a DC-DC battery charger. The output from the unit is tailored specifically to the selected output battery type, and therefore allows the optimal charging of the auxiliary battery, no matter what chemistry your start battery is.

**Q My BCDC is setup for 12V Alternator input but will not start when the vehicle is turned On, I've followed the trouble shooting guide and the setup is fine, what's the problem?**

**A** The most likely cause of this issue is that the BCDC is somehow 'stuck' in 24V mode. Try removing the 'Source Select' (Blue) wire and reconnecting it. If the problem still exists please contact Redarc Electronics.

## 5 TWO YEAR PRODUCT WARRANTY

Over the last three decades our company has established a reputation as the power conversion specialist.

A 100% Australian-owned company, we have met the needs of customers in transport and other industries through exciting, innovative thinking.

We believe in total customer satisfaction and practice this by offering our customers:

- Technical advice free of jargon and free of charge
- Prompt turnaround of orders throughout Australia and globally
- Friendly, personalised, professional service and product support

In the unlikely event that a technical issue arises with a Redarc product, customers are encouraged to initially contact the Redarc Technical Support Team on +61 8 8322 4848 or [power@redarc.com.au](mailto:power@redarc.com.au) for prompt and efficient diagnosis and product support.

Our goods come with guarantees that cannot be excluded under the Australian Consumer Law. You are entitled to a replacement or refund for a major failure and compensation for any other reasonably foreseeable loss or damage. You are also entitled to have the goods repaired or replaced if the goods fail to be of acceptable quality and the failure does not amount to a major failure.

The benefits of this Warranty are in addition to other rights and remedies available at law in respect of the Products and shall not derogate from any applicable mandatory statutory provisions or rights under the Australian Consumer Law.

Redarc Electronics Pty Ltd aff the Redarc Trust trading as Redarc Electronics ("Redarc") offers a warranty in respect of its Products where the Products are purchased from an authorised distributor or reseller of Redarc by a person ("Purchaser"), on the terms and conditions, and for the duration, outlined below in this document ("Warranty").

1. In this Warranty, the term **Products** means:
  - 1.1 all products manufactured or supplied by Redarc (excluding its solar products which are covered by Redarc's Solar Product Warranty); and
  - 1.2 any component of or accessory for any product in clause 1.1 manufactured or supplied by Redarc.
2. **Offer and duration of product warranties**

Redarc warrants that its Products will be free, under normal application, installation, use and service conditions, from defects in materials and workmanship affecting normal use, for **2 years** from the date of purchase (**Warranty Period**).
3. Where a Product malfunctions or becomes inoperative during the Warranty Period, due to a defect in materials or workmanship, as determined by Redarc, then subject to further rights conferred by the Australian Consumer Law on the Purchaser, Redarc will, in exercise of its sole discretion, either:
  - 3.1 repair the defective Product;
  - 3.2 replace the defective Product; or
  - 3.3 provide a refund to the Purchaser for the purchase price paid for the defective Product,without charge to the Purchaser.
4. The warranty given by Redarc in clause 3 covers the reasonable costs of delivery and installation of any repaired or replaced Products or components of Products to the Purchaser's usual residential address notified to Redarc, together with the reasonable costs of removal and return of any Products determined by Redarc to be defective.
5. If the Purchaser incurs expenses of the nature referred to in clause 4 in the context of making a claim pursuant to this Warranty that is accepted by Redarc, the Purchaser will be entitled to claim for reimbursement of those expenses which Redarc determines, in exercise of its sole discretion, to be reasonably incurred, provided that the claim is notified to Redarc in writing at the postal address or email address specified in clause 21 and includes:
  - 5.1 details of the relevant expenses incurred by the Purchaser; and
  - 5.2 proof of the relevant expenses having been incurred by the Purchaser.

### Exclusions and limitations

6. This Warranty will not apply to, or include any defect, damage, fault, failure or malfunction of a Product, which Redarc determines, in exercise of its sole discretion, to be due to:
  - 6.1 normal wear and tear or exposure to weather conditions over time;
  - 6.2 accident, misuse, abuse, negligence, vandalism, alteration or modification;
  - 6.3 non-observance of any of the instructions supplied by Redarc, including instructions concerning installation, configuring, connecting, commissioning, use or application of the Product, including without limitation choice of location;
  - 6.4 failure to ensure proper maintenance of the Product strictly in accordance with Redarc's instructions or failure to ensure proper maintenance of any associated equipment or machinery;
  - 6.5 repairs to the Product that are not strictly in accordance with Redarc's instructions;
  - 6.6 installation, repairs or maintenance of the Product by, or under the supervision of, a person who is not a qualified auto electrician or technician, or if non-genuine or non-approved parts have been fitted;
  - 6.7 faulty power supply, power failure, electrical spikes or surges, lightning, flood, storm, hail, extreme heat, fire or other occurrence outside the control of Redarc;
  - 6.8 use other than for any reasonable purpose for which the Product was manufactured;
  - 6.9 any indirect or incidental damage of whatever nature outside the control of Redarc.
7. Warranty claims in respect of a Product must be made in writing to Redarc at the postal address or email address specified in clause 21 within the Warranty Period. Such claims must include the following:
  - 7.1 details of the alleged defect or fault and the circumstances surrounding the defect or fault;
  - 7.2 evidence of the claim, including photographs of the Product (where the subject of the claim is capable of being photographed);
  - 7.3 the serial number of the Product, specified on the label affixed to the Product; and
  - 7.4 proof of purchase documentation for the Product from an authorised distributor or reseller of Redarc, which clearly shows the date and place of purchase.The return of any Products without the prior written instructions of Redarc will not be accepted by Redarc.

8. Without limiting any other clause in this Warranty, Redarc has the right to reject any Warranty claim made by a Purchaser pursuant to this Warranty where:
  - 8.1 the Purchaser does not notify Redarc in writing of a Warranty claim within the Warranty Period;
  - 8.2 the Purchaser does not notify Redarc in writing of a Warranty claim within 1 month of becoming aware of the relevant circumstances giving rise to the claim, so that any further problems with the Product are minimised;
  - 8.3 the serial number of the Product has been altered, removed or made illegible without the written authority of Redarc;
  - 8.4 the Purchaser is unable to provide proof of purchase documentation in accordance with clause 7.4 or evidence that the Product was properly installed and removed (if relevant), and that proper maintenance has been performed on the Product, by, or under the supervision of, a qualified auto electrician or technician, in accordance with the instructions of Redarc.
9. If the Product is found to be working satisfactorily on return to Redarc or upon investigation by Redarc, the Purchaser must pay Redarc's reasonable costs of testing and investigating the Product in addition to shipping and transportation charges. Where Redarc is in possession of the Product, the Product will be returned to the Purchaser on receipt of the amount charged.
10. Any replaced Products or components of Products shall become the property of Redarc.
11. Redarc may, in exercise of its sole discretion, deliver another type of Product or component of a Product (different in size, colour, shape, weight, brand and/or other specifications) in fulfilling its obligations under this Warranty, in the event that Redarc has discontinued manufacturing or supplying the relevant Product or component at the time of the Warranty claim, or where such Product or component is superior to that originally purchased by the Purchaser.

### Other conditions of Warranty

12. If the Purchaser acquired a Product for the purpose of resupply, then this Warranty shall not apply to that Product.
13. In particular, the sale of a Product via an online auction, online store or other internet website by a party that is not an authorised distributor or reseller of the Product will be deemed to be a resupply within the meaning of the Australian Consumer Law and will render this Warranty void, as Redarc has no control over the storage, handling, quality or safety of Products sold by such persons.
14. A Purchaser shall only be entitled to the benefit of this Warranty after all amounts owing in respect of the Product have been paid.
15. While Redarc warrants that the Products will be free from defects in materials and workmanship in the circumstances set out in this Warranty, to the maximum extent permitted by law Redarc does not warrant that the operation of the Products will be uninterrupted or error-free.
16. To the maximum extent permitted by law, Redarc's determination of the existence of any defect and the cause of any defect will be conclusive.
17. Spare parts or materials for the Products are guaranteed to be available for a period of at least 2 years after purchase of the Products.
18. The agents, officers and employees of any distributor or reseller of the Products and of Redarc are not authorised to vary or extend the terms of this Warranty.
19. Redarc shall not be responsible or liable to the Customer or any third party in connection with any non-performance or delay in performance of any terms and conditions of this Warranty, due to acts of God, war, riots, strikes, warlike conditions, plague or other epidemic, fire, flood, blizzard, hurricane, changes of public policies, terrorism and other events which are beyond the control of Redarc. In such circumstances, Redarc may suspend performance of this Warranty without liability for the period of the delay reasonably attributable to such causes.
20. If a clause or part of a clause in this Warranty can be read in a way that makes it illegal, unenforceable or invalid, but can also be read in a way that makes it legal, enforceable and valid, it must be read in the latter way. If any clause or part of a clause in this Warranty is illegal, unenforceable or invalid, that clause or part is to be treated as removed from this Warranty, but the rest of this Warranty is not affected.

### Redarc's contact details

21. Redarc's contact details for the sending of Warranty claims under this Warranty are:

Redarc Electronics Pty Ltd  
23 Brodie Road (North), Lonsdale South Australia 5160  
Email: [power@redarc.com.au](mailto:power@redarc.com.au)  
Telephone: +61 8 8322 4848

THE POWER OF  
**REDARC**®

**Free technical assistance!**

please contact

REDARC Electronics

23 Brodie Road North, Lonsdale South Australia

+61 8 8322 4848

[power@redarc.com.au](mailto:power@redarc.com.au)

[www.redarc.com.au](http://www.redarc.com.au)

Copyright © 2017 REDARC Electronics Pty Ltd. All rights reserved.

WARBCDC2410 - REV1

[www.redarc.com.au](http://www.redarc.com.au)