

THE POWER OF

REDARC®

Tow-Pro® Elite

Electric Trailer Brake Controller

12 V or 24 V, 1 to 3 Axles

MODEL:

- EBRH-ACCV3-NA

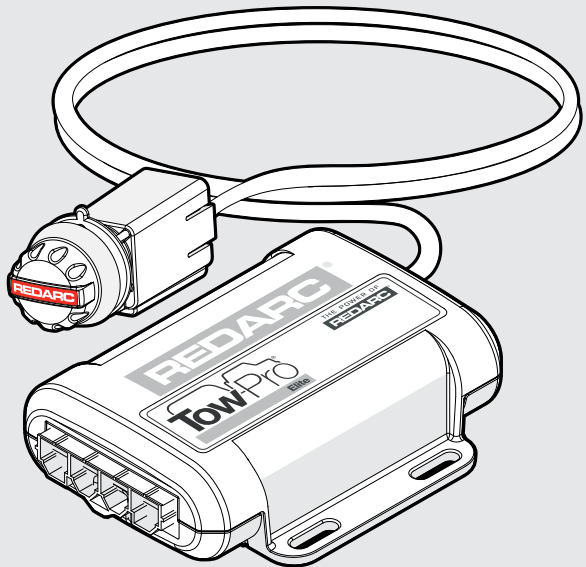

Tow-Pro® Elite

Electric Trailer Brake Controller (EBRH-ACCV3-NA)

The Tow-Pro® Elite is an electric trailer brake controller designed to suit most common trailer braking applications. It requires minimal dash space and is simple to install and operate.

The Tow-Pro® Elite has selectable Proportional or User Controlled trailer braking modes that allow you to choose the braking style depending on the road or terrain conditions, vehicle type, or driver preference.

The Tow-Pro® Elite features Active Calibration which constantly monitors the direction of travel and will even calibrate with no trailer attached, and can be mounted in any orientation.

The unit is able to operate electric trailer brakes from either 12V or 24 V vehicle systems without the need for manual selection or extra components or wiring.

The unit is able to operate Electric/ Hydraulic trailer brakes from 12 V vehicle systems.

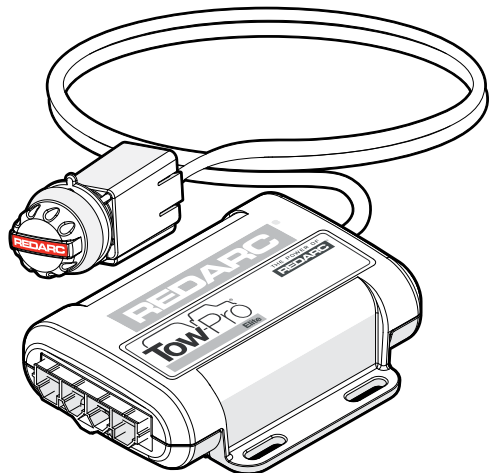

CONTENTS

WARNINGS AND SAFETY INSTRUCTIONS	4
1 SPECIFICATIONS	6
1.1 Kit Contents	7
1.2 Dimensions and Connection	8
2 INSTALLATION	9
2.1 Mounting the main unit	9
2.2 Wiring the brake controller	10
2.3 Mounting the Remote Head	14
2.4 Active Calibration	16
3 OPERATION	17
3.1 Adjusting the Braking Force	17
3.2 Manual Override	17
3.3 Operating Modes	18
3.4 Park Brake Feature	20
3.5 Visual User Guide	20
3.6 LED Indication	21
3.7 Troubleshooting	22
4 PERIODIC MAINTENANCE AND CHECKS	24
5 FREQUENTLY ASKED QUESTIONS	25
6 FCC DECLARATION	26
7 WARRANTY	27

WARNINGS AND SAFETY INSTRUCTIONS

SAVE THESE INSTRUCTIONS — This manual contains important safety instructions for the Tow-Pro® Elite Electric Trailer Brake Controller.

Do not operate the controller unless you have read and understood this manual and the controller is installed as per these installation instructions. REDARC recommends that the charger be installed by a suitably qualified person.

SAFETY MESSAGE CONVENTIONS

Safety messages in this manual include a signal word to indicate the level of the hazard as follows:

▲ WARNING

A potentially hazardous situation which **could result in death or serious injury to the operator or to bystanders.**

▲ CAUTION

A potentially hazardous situation which **may result in moderate or minor injury to the operator or to bystanders.**

NOTICE

A situation that **may cause equipment damage.**

▲ WARNING

- Ensure that your trailer brakes are installed and are operating correctly;
- Improperly installed and/or faulty trailer brakes can cause erratic vehicle or trailer behavior with the potential to cause a road accident. For this reason, it is of utmost importance that your trailer braking system be installed/maintained by a qualified installer.
- Always check brakes at low speed each time a trailer is attached to your vehicle.

▲ CAUTION

1. Ensure that the Tow-Pro® Elite is mounted securely in a fixed location. Failure to mount securely will result in inaccurate braking force measurements and incorrect braking of the trailer.
2. Ensure that the Tow-Pro® Elite is installed inside the vehicle cabin and away from any environmental conditions that may cause damage, including engine heat, submersion in water, salt spray and humidity. Exposure to these conditions may cause damage to the unit's circuitry and may cause erratic trailer braking.
3. A Fuse or Circuit Breaker of appropriate rating must be installed to protect the vehicle system. Please refer to the installation instructions starting on [page 9](#) for specific instructions on where to install the Fuse or Circuit Breaker and for appropriate Fuse or Circuit Breaker rating. The Fuse or Circuit Breaker must be installed as close as possible to the battery.

4. Ensure the remote head push-button activates correctly when installed into surfaces with a thickness greater than 1/8" (3.2 mm). Failure to activate correctly would result in not being able to activate the override function or change modes.
5. Ensure that the wire(s) and all connections used to install the Tow-Pro® Elite are suitably rated to supply the required current to simultaneously operate the trailer electric brakes and stop lamps. Incorrect wiring can result in reduced (or total loss of) trailer braking and/or damage to property or persons.
6. The Tow-Pro® Elite is suitable for trailers with electric brakes up to three axles. Note that Federal and State laws apply to trailer weights and brake controller requirements. Please consult your local authority to ensure you comply with the legal requirements.
7. Do not drive with the Tow-Pro® Elite while a fault code is active. Fault codes of the Tow-Pro® Elite may indicate conditions that make it unsafe or illegal to drive, including unreliable trailer brakes or failure of brake lights.
8. During the calibration step of the Tow-Pro® Elite, braking of the trailer may be inconsistent. REDARC recommends calibrating the Tow-Pro® Elite without a trailer attached. A normal drive of a few miles will do for this purpose. If calibrating with a trailer attached, then the recommended dial setting for the Tow-Pro® Elite is 4 or less.

NOTICE

1. Ensure that a correct grounding point is used. Vehicles often have ungrounded metal reinforcements under the dash and these points are not suitable grounds. Bad grounding of the unit will result in poor or no operation.
2. The Tow-Pro® Elite does not act as a trailer lights voltage converter. If the trailer brake lights operate on a different voltage, damage to the vehicle; trailer and/or Tow-Pro® Elite and associated wiring may result. This may also result in reduced (or total loss of) trailer braking.
3. When installing the Tow-Pro® Elite Remote Control to a thin panel, washers are recommended to reinforce the structure of the panel.
4. Do NOT exceed Tow Vehicle and Trailer weights and specifications. Failure to abide by the towing regulations, including maximum loads, may result in a fine, or in case of an accident, refusal of the insurance claim, and the possibility of further legal action.

If the tow vehicle or trailer's maximum load is exceeded, police and transport authorities have the power to order the combination off the road until the issue is corrected. This may necessitate leaving the trailer on the side of the road while a vehicle with suitable towing capacity is sourced or the trailer load is reduced. Please contact your local authorities for further information.

5. If no trailer is connected, Active Calibration may occur as normal without any indication from the LED. The LED will already be Blue when the trailer is connected. Essentially, whether a trailer is connected or not, just drive normally and Active Calibration will ensure the Tow-Pro® Elite learns the correct direction of travel.

1 SPECIFICATIONS

Part Number	EBRH-ACCV3-NA	
Operating Voltage	9 V to 32 V	
Nominal Input System Voltage	12 V	24 V
Brake Input Signal Voltage	OFF: 0 V ON: +12 V nominal	OFF: 0 V ON: +24 V nominal
Brake Coil Voltage	12 V	
Max. Trailer Axles	3 Axles	
Nominal Current Draw	18 A	
Max. Rated Current	25 A	30 A
Standby Current	< 5 mA	
Operating Temp	-4°F to 140°F (-20°C to +60°C)	
Weight	7.05 oz (200 g)	
Warranty	2 years	
EMC Compliance	FCC, ICES	

1.1 Kit Contents

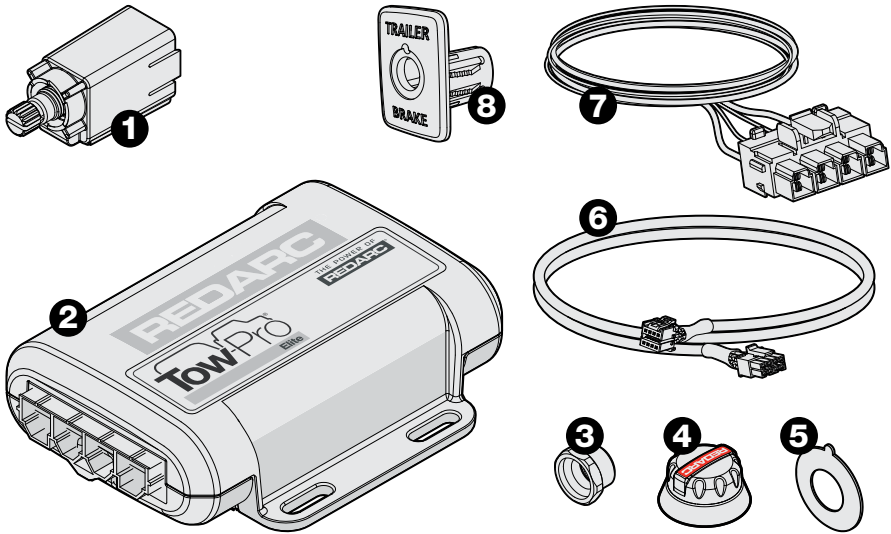

Reference	Description
1	Remote Head Assembly
2	Main Unit
3	Remote Head Nut
4	Remote Head Knob
5	Remote Head Bezel
6	Remote Head Cable 3'3" (1 m)
7	Main Unit Wires and Connector 1'7" (0.5 m)
8	Tow-Pro Universal Switch Insert Panel

1.2 Dimensions and Connection

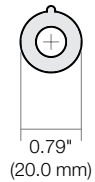
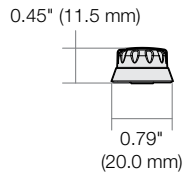
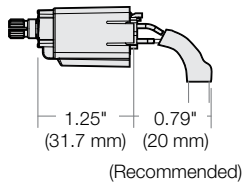
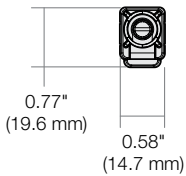
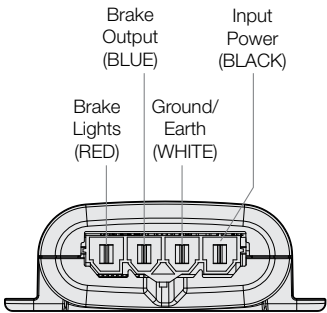
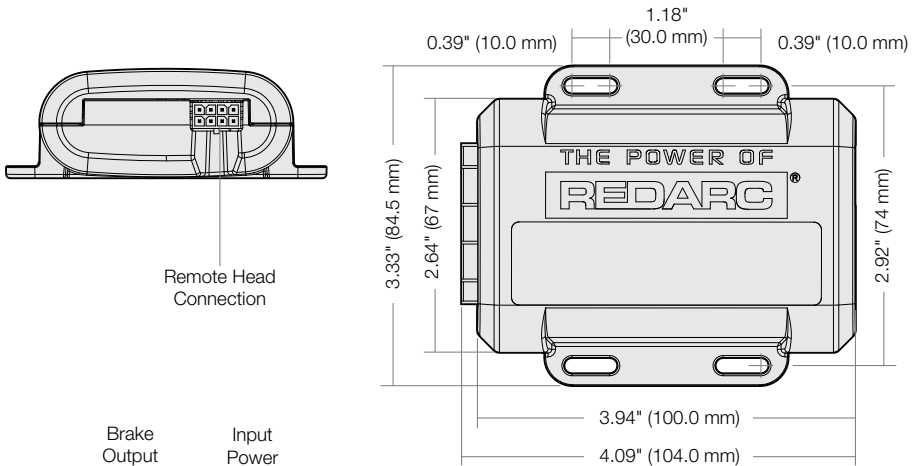

2 INSTALLATION

2.1 Mounting the main unit

The Tow-Pro® Elite should be mounted inside the vehicle cabin using either $\frac{5}{32}$ " (M4) diameter screws or other secure fitting methods at the mounting points provided. It is essential to mount the unit in a location which allows access to the intended remote head location.

The Tow-Pro® Elite can be mounted in any orientation as long as the installation is secure and the main unit cannot move or change orientation once installed. A change of orientation will affect the system calibration.

⚠ CAUTION

- Ensure that the Tow-Pro® Elite is mounted securely in a fixed location. Failure to mount securely will result in inaccurate braking force measurements and incorrect braking of the trailer.
- Ensure that the Tow-Pro® Elite is installed inside the vehicle cabin and away from any environmental conditions that may cause damage, including engine heat, submersion in water, salt spray and humidity. Exposure to these conditions may cause damage to the unit's circuitry and may cause erratic trailer braking.

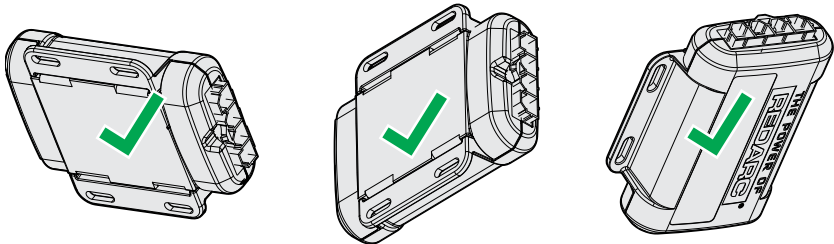

Any secure location ok

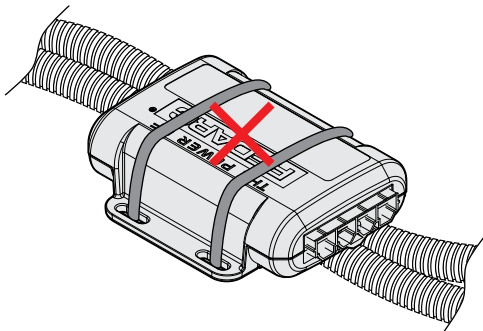

Do Not Mount to Cables/Wiring Looms (Must be mounted to a rigid or solid object or surface)

2.2 Wiring the brake controller

REDARC Electronics manufactures a number of vehicle-specific wiring harnesses for quick and easy installation (refer to REDARC's website for details). The universal wiring harness included with the EBRH-ACCV3-NA kit is the TPH-025 'Universal Harness' which is typically used for older vehicles not covered by our range of wiring harnesses. Please follow the subsequent instructions for all custom installations.

⚠ CAUTION

- A Fuse or Circuit Breaker of appropriate rating must be installed to protect the vehicle system. Please refer to the installation instructions starting on [page 9](#) for specific instructions on where to install the Fuse or Circuit Breaker and for appropriate Fuse or Circuit Breaker rating. The Fuse or Circuit Breaker must be installed as close as possible to the battery.
- Ensure that the wire(s) and all connections used to install the Tow-Pro® Elite are suitably rated to supply the required current to simultaneously operate the trailer electric brakes and stop lamps. Incorrect wiring can result in reduced (or total loss of) trailer braking and/or damage to property or persons.

NOTICE

The Tow-Pro® Elite does not act as a trailer lights voltage converter. If the trailer brake lights operate on a different voltage, damage to the vehicle; trailer and/or Tow-Pro® Elite and associated wiring may result. This may also result in reduced (or total loss of) trailer braking.

2.2.1 RED WIRE (VEHICLE BRAKE LIGHT) CONNECTION

The requirements for a suitable connection of a brake controller trigger wire are quite specific. This connection point must:

- Provide a voltage of the same voltage level as the "Start Battery*" while the vehicle brakes are applied.
- Have 0 volts output while the vehicle brakes are not applied
- Accept battery voltage input when the brake controller manual over-ride is operated and illuminate at least the trailer brake lights.
- Accept the battery voltage input as above without causing any damage, spurious vehicle operation or erroneous fault indication.

A relay should not be installed to drive the red wire as this would prevent the override feature from working and may introduce dangerous voltage spikes.

* Start Battery voltage output means directly from the Start Battery and within 0.4 V of Supply (Black wire) voltage.

2.2.2 WIRING – ELECTRIC BRAKES

For 12 V and 24 V vehicle electrical systems, the Tow-Pro® Elite is designed to operate electric brakes without the need for any additional converters.

For wire selection refer to the wiring gauge guide "[Wiring Gauge Guide](#)" on page 24.

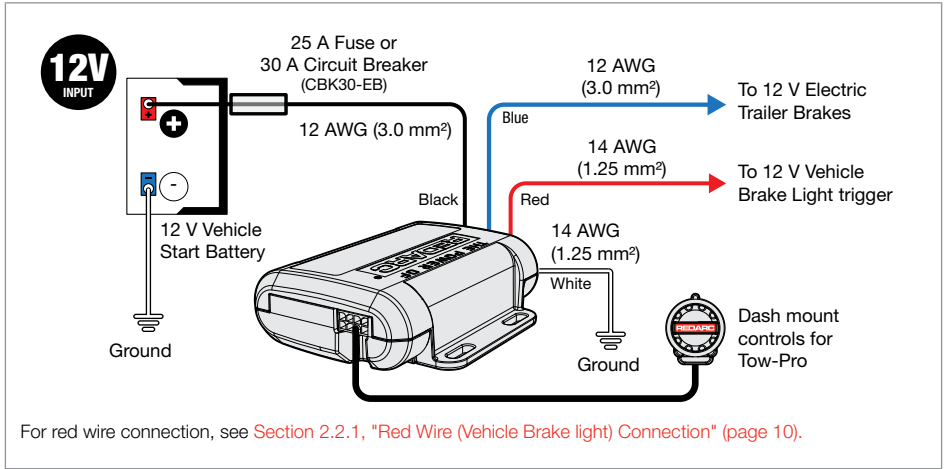

NOTICE

The Input Power (Black) wire must be connected directly to the positive terminal of the start battery via a Fuse (25 A) or Circuit Breaker (30 A) and not through an Ignition source.

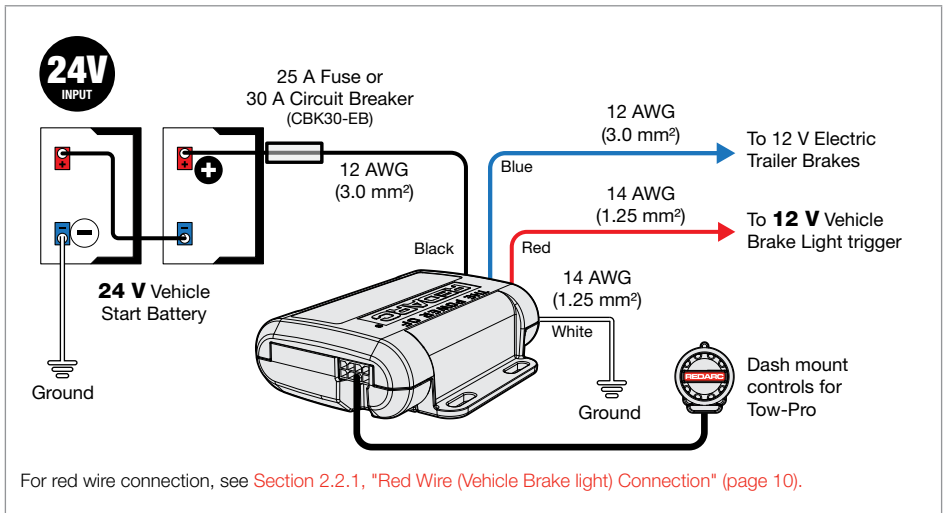

2.2.3 WIRING – ELECTRIC/HYDRAULIC BRAKES

NOTICE

Always refer to the manufacturer's specifications for your Electric/Hydraulic Braking system prior to installation and usage of the Tow-Pro® Elite.

12 V VEHICLE SYSTEMS

The Tow-Pro® Elite is designed to operate both Electric trailer brake systems and 12 V Electric/Hydraulic trailer brake systems. However, most Electric/Hydraulic systems require a separate 12 V power feed for the hydraulic pump. For example:

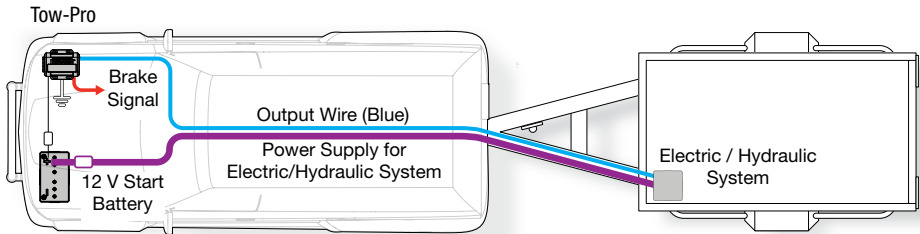

For wire selection refer to the wiring gauge guide in [Section 6, "Wiring Gauge Guide"](#) (page 24).

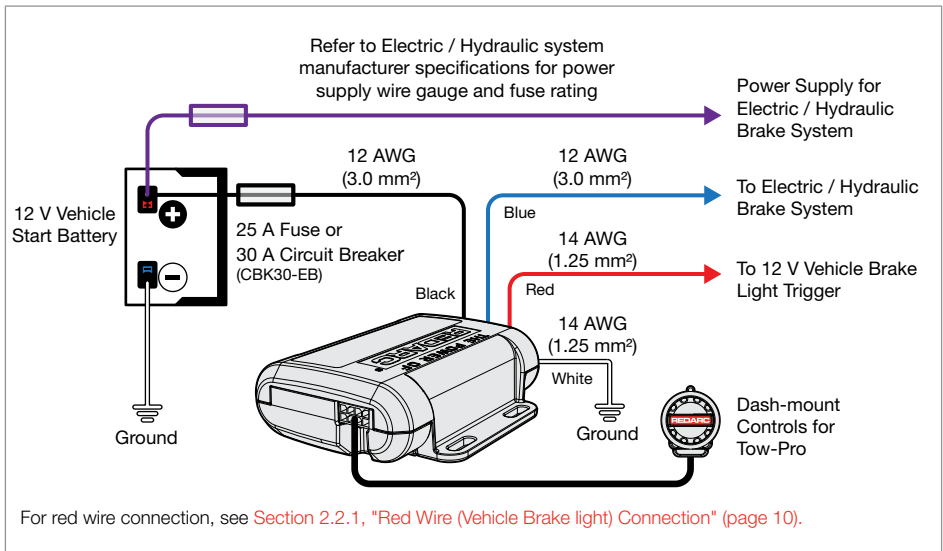

24 V VEHICLE SYSTEMS

Since Electric/Hydraulic braking systems can be sensitive to 24 V inputs depending on the electronics within the hydraulic pump system the The EBRH-ACCV3-NA should only be used with electric/hydraulic braking systems in 12 V vehicles.

2.2.4 WIRING – VEHICLES WITH CAN BUS SYSTEM

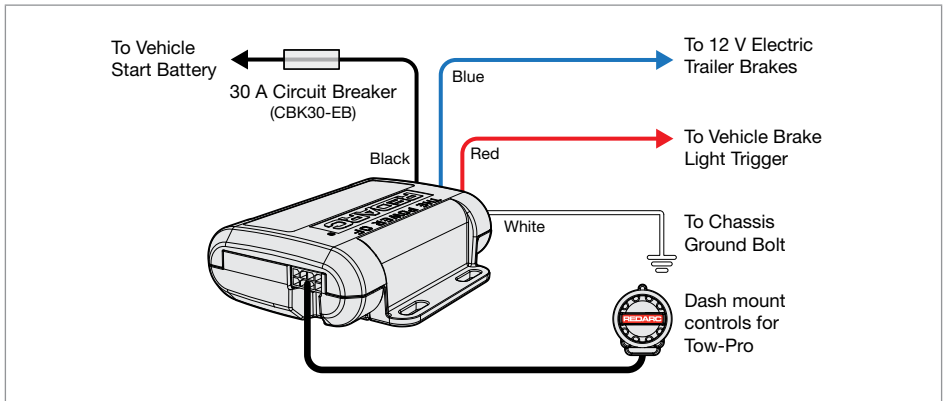

Many modern vehicles use a CAN Bus system for signalling when to apply the vehicles brakes as required by safety systems including adaptive cruise control, stability control, Autonomous Emergency Braking (AEB) and hill descent control. For these vehicles, REDARC recommend the following wiring configuration.



2.2.5 WIRING GAUGE GUIDE

This diagram outlines the required wire cross sectional areas for the Tow-Pro® Elite installations detailed in [Section 2.2, "Wiring the brake controller"](#) (page 8).

All wire ratings refer to the **minimum** required cross sectional area of copper only (not including insulation). Always use a wire gauge equal to or greater than what is specified in this guide.

Black (12 V)	Blue	White	Red
			
3 mm ²	3 mm ²	1.6 mm ²	1.6 mm ²
12 AWG	12 AWG	14 AWG	14 AWG

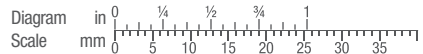

2.3 Mounting the Remote Head

The Tow-Pro® Elite remote head is designed to be mounted at a distance from the main unit, allowing for a neat, convenient installation and not impeding on lower leg airbags or driver leg room. The Tow-Pro® Elite remote head is designed to be mounted on or around the vehicle dashboard and when installed correctly, complies with Australian Design Rule (ADR) 21, which sets requirements for devices mounted on the dashboard.

The Tow-Pro® Elite remote head can be mounted directly to the dashboard, to the center console or through a spare knock-out switch panel and requires only one hole to be drilled as per the Mounting Guide in [Section 2.6 on page 13](#). For easy access in an emergency situation, REDARC recommend installing the remote head within reach of the driver such as the regions shaded in the diagram.

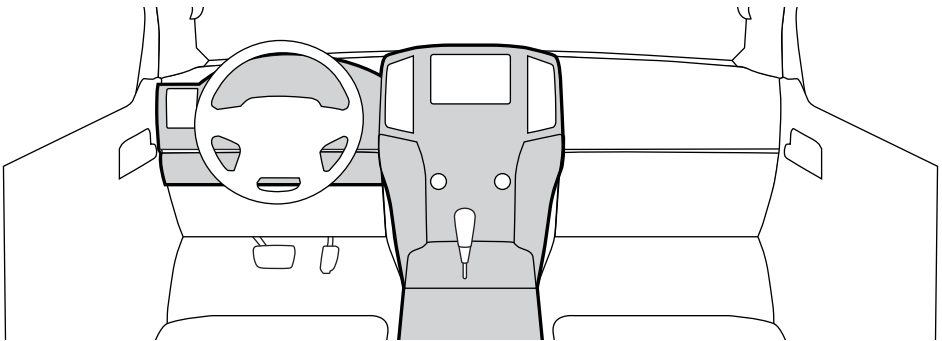

2.3.1 INSTALLATION ACCESSORIES

REDARC offer a range of vehicle specific switch inserts and vehicle specific wiring kits designed to make the installation of the Tow-Pro Elite easier.

The range includes most popular SUV and LCV's and is frequently being updated and added to. A full listing of Switch Inserts and Wiring Kits is available for purchase on the REDARC website.

2.3.2 UNIVERSAL SWITCH PANEL INSERT

Refer to the TPSI-001 installation instructions included with this kit.

2.3.3 MOUNTING THE REMOTE HEAD ON A DASH OR CONSOLE PANEL

Ensure that there is enough space behind the mounting location to fit the Tow-Pro control head and remote head cable before drilling any holes.

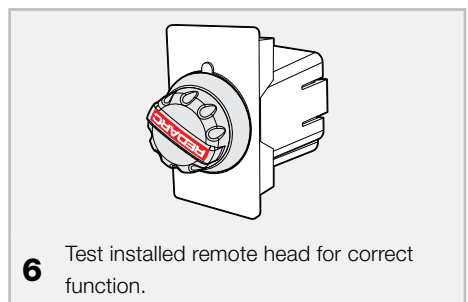
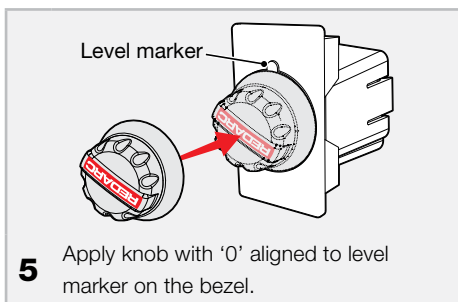
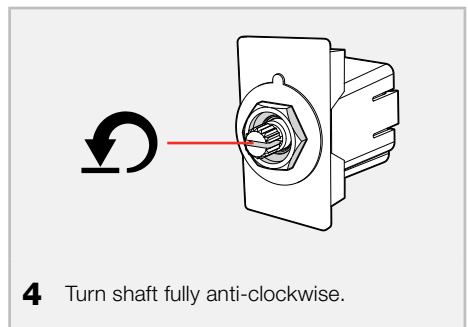
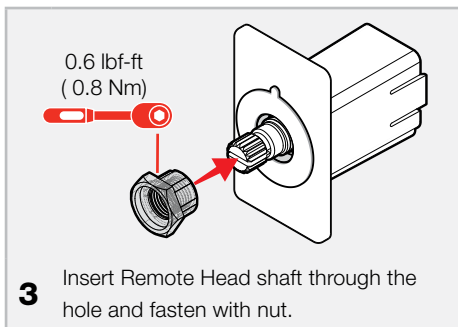
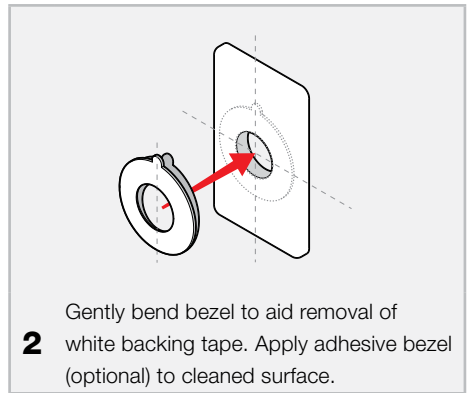
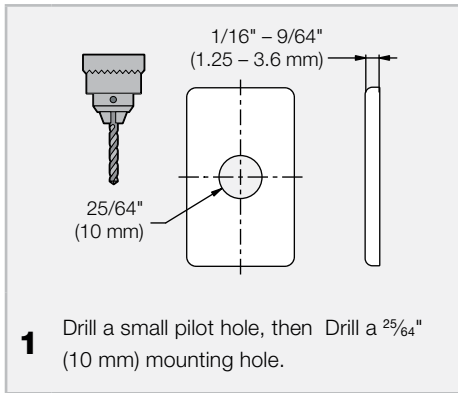

⚠ CAUTION

Ensure the remote head push-button activates correctly when installed into panels with a thickness greater than $\frac{1}{8}$ " (3.2 mm). Failure to activate correctly would result in not being able to activate the override function or change modes.

2.4 Active Calibration

When the unit is first powered, Active Calibration must first become confident in the vehicle direction of travel. Until this time the LED will flash Blue/Green.

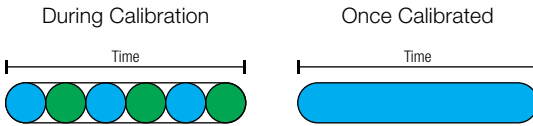

Active Calibration constantly monitors the vehicle's direction of travel and allows the Tow-Pro® Elite to 'learn' and continuously confirm its mounting orientation. This process occurs whilst the vehicle is moving and the brake is applied and will occur with or without a trailer connected.

When the Tow-Pro® Elite is first installed it will begin learning its mounting orientation through Active Calibration as soon as you start driving, at this point Proportional Mode is selected but not yet fully operational.

Until the Tow-Pro® Elite has determined its mounting orientation the unit will function as if in User-Controlled mode, this is indicated by the LED glowing green with blue flashes. As the Tow-Pro® Elite becomes more confident of its direction of travel the length of the Blue flash will increase, to the point that the LED is solid Blue which indicates it is now operating completely in Proportional mode.

Under normal driving conditions the Tow-Pro® Elite will learn its mounting orientation within 20 brake applications. Note that the braking must be perceptible (applying the brake while stopped will not assist calibration).

If power is disconnected (for example, if the vehicle battery is changed) calibration memory will be lost and the unit will recalibrate itself using active calibration. This is similar to a radio losing its clock or preset station memory.

NOTICE

If no trailer is connected, Active Calibration may occur as normal without any indication from the LED. The LED will already be Blue when the trailer is connected. Essentially, whether a trailer is connected or not, just drive normally and Active Calibration will ensure the Tow-Pro® Elite learns the correct direction of travel.

3 OPERATION

3.1 Adjusting the Braking Force

In both modes the braking level can be adjusted to suit varying trailer loads, braking requirements or user comfort by adjusting the control knob on the remote head.



The lower end of the scale (below level 5) should be used as a starting point and adjusted accordingly once braking requirements are established.

If a lighter braking level is required, turn the control knob to a lower number (anti-clockwise) to reduce the trailer braking force. Similarly, turn the gain control knob to a higher number (clockwise) to increase the trailer braking force.

The braking level will be indicated by the LED changing to a shade of RED when the brakes are applied. The higher the braking level, the more RED the LED will glow.

A setting of '0' will result in no trailer braking output.

3.2 Manual Override

Pressing the gain control knob whilst driving will apply the manual override brake. The manual override brake will apply the trailer brakes only, and will also apply the trailer brake lights and will turn the LED indicator RED. Depending on the vehicle wiring it may also apply the vehicle brake lights.

The manual override is designed to be used when the trailer brakes need to be applied without the vehicle brakes, such as correcting trailer 'sway' whilst traveling.

In **Proportional** mode the manual override will apply the trailer brake to a level equivalent to 'light' vehicle braking.

In **User Controlled** mode the manual override will apply the trailer brakes to the level set on the gain control knob.

In both modes the braking force can be adjusted by turning the gain control knob even whilst applying the manual override brakes.

Manual override should not be used in place of the regular vehicle brakes.

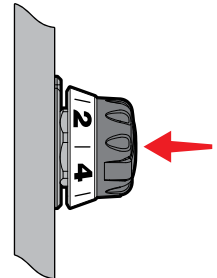

3.3 Operating Modes

The Tow-Pro® Elite offers two modes of operation — **Proportional** and **User Controlled**. On the first application of power to the black wire, the Tow-Pro® Elite will start-up in Proportional mode. Every time a trailer is connected, the Tow-Pro® Elite will start up in the mode that was last selected (provided the black wire has remained connected to power/battery positive).

3.3.1 PROPORTIONAL MODE (BLUE LED)

If the status indication LED on the control knob is glowing BLUE, the Tow-Pro® Elite is in **Proportional Mode**.

In Proportional Mode, the Tow-Pro® Elite will apply the trailer brakes at a level proportional to the vehicle deceleration. The control knob setting, 0 to 10, will set the brakes from a lighter to a heavier trailer brake application. Simply put, **the harder the vehicle brakes are applied, the harder the trailer will brake**. This mode is designed for highway traveling or everyday use and requires minimal input from the user whilst traveling.



3.3.2 USER CONTROLLED MODE (GREEN LED)

If the status indication LED on the control knob is glowing GREEN, the Tow-Pro® Elite is in **User Controlled Mode**.

In User Controlled Mode, the Tow-Pro® Elite will apply the trailer brakes to the level set by the user on the gain control knob. The control knob setting, 0 to 10, will set the brakes from Zero to Full trailer brake application. Simply put, **the trailer will brake to the level set by the control knob (regardless of how hard the vehicle brakes)**. This mode is often preferred for off road or precision use and may require frequent attention from the user.



NOTICE

It is important to consider the road surface and conditions when selecting a mode and level setting. When changing conditions we advise to review your controller settings and adjust according to your preference.

3.3.3 CHANGING MODES

Changing modes can only be completed with a trailer connected. Ensure the vehicle has come to a complete stop before beginning the mode change process.

Changing between modes requires the user to complete the following process:

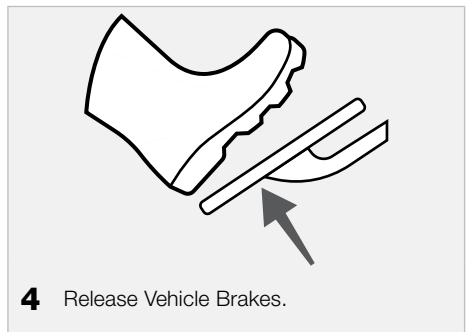
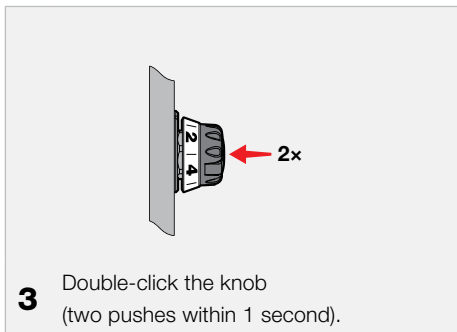
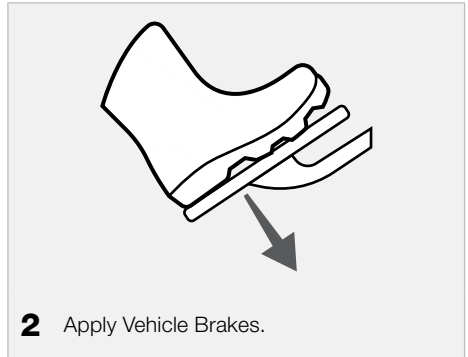
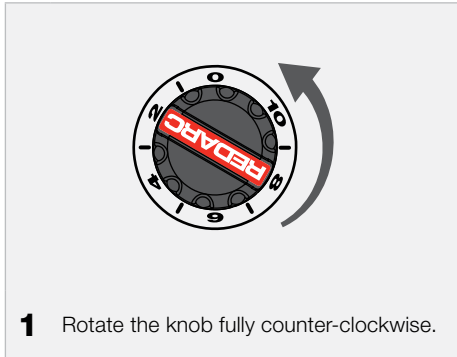

NOTICE



If you are unable to change modes, check that the remote head is not installed into a panel which is too thick and that the button is able to be depressed fully. Refer to "[2.3.3 Mounting the Remote Head on a Dash or Console Panel](#)" on page 15 for details.

Ensure you reset the dial to a suitable braking level after changing modes.

3.4 Park Brake Feature

If the Tow-Pro® Elite detects that the vehicle brakes are applied for longer than 3 seconds whilst the vehicle is stationary, it will apply the trailer brakes in an intelligent manner to reduce the required braking effort whilst decreasing the risk of rolling forward or backward whilst stopped. If the controller determines the trailer brakes are not required to keep the vehicle stationary, the output will be decreased to Zero.

3.5 Visual User Guide

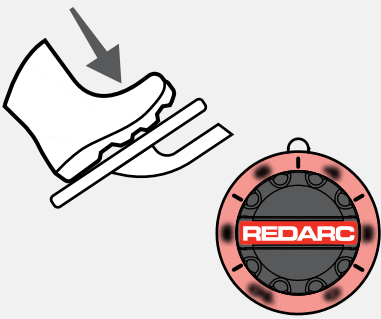
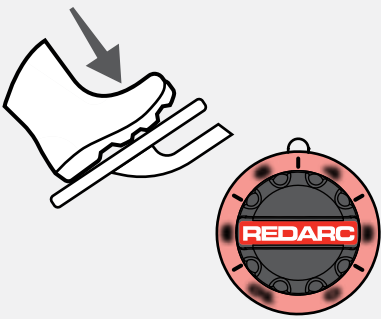
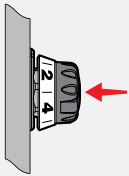
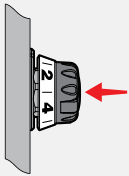
<h3>Proportional Mode</h3> <p>Blue LED</p>  <p>Lighter trailer</p> <p>Heavier trailer</p>	<h3>User Controlled Mode</h3> <p>Green LED</p>  <p>Lighter brake force</p> <p>Heavier brake force</p>
<p>1 Rotate knob to adjust brake level.</p> 	<p>1 Rotate knob to adjust brake level.</p> 
<p>3 Light application of Trailer Brakes only.</p> 	<p>3 Applies Trailer Brakes only, to the level set on the gain control knob.</p> 

3.6 LED Indication

The Tow-Pro® Elite will indicate both Mode and Fault Condition through color and flash sequences of the LED indicator. The table shows how the Tow-Pro® Elite will indicate Operation of the unit.

NOTE: LEDs will glow full brightness when gain control is adjusted or manual override is pressed. After release of the gain control knob the LED brightness will reduce. This is designed to be less intrusive on driver's vision at night.

Table 3.6.1: LED Indications		
	Proportional Mode	User Controlled Mode
Calibration	Blue/Green flashing	Not Applicable
Sleep Mode¹	Blue 'Breathing' on button push ²	
Trailer Connected	Solid Blue	Solid Green
Braking	Blue to Red ³	Green to Red ³
Fault Code (Trailer braking performance potentially compromised)	Flashing in any sequence (other than Blue/Green) Refer to Section 3.7, "Troubleshooting" (page 22) or contact an experienced auto-electrician.	

1. Sleep Mode occurs when there is no trailer connected to the vehicle.
2. 'Breathing', as opposed to flashing, is the LED gradually getting brighter until its brightest point and then gradually dimming until off. In the event of trailer disconnection, breathing will occur after 1 minute.
3. The LED will vary between the Mode Color (Blue or Green) and Red depending on the braking force.

3.7 Troubleshooting

The Tow-Pro® Elite features sophisticated diagnostics to warn the operator of faults in the vehicle and trailer brake wiring. Wiring faults are indicated by a series of color coded flash patterns on the Tow-Pro® Elite LED.







Most faults turn out to be something simple such as a poor connection from a dirty trailer socket, however a fault indication should not be ignored. It is a warning; if left unattended such wiring faults can become worse and may lead to deterioration or loss of trailer braking.



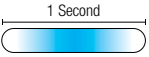

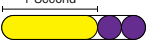
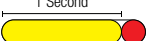



Refer to the table on pages 20 and 21 for the list of flash patterns, showing the cause and recommended course of action for each of the conditions which may be detected.

NOTICE

Even intermittent faults are detected and may be indicated until cleared.

Fault codes can be cleared by unplugging the trailer for 1 minute then reconnecting.

LED Sequence	Symptom/Description	Possible Cause	Suggested Action
	BLUE Breathing when the Override button is pushed	The trailer brakes have not been detected OR the trailer is not plugged in	Check the trailer plug and all connections between the controller & brakes
	Flashing a Blue/Green sequence	The unit is in the process of calibrating, this is NOT a fault	Keep driving normally and the unit will calibrate
	The LED is YELLOW and flashes PURPLE twice	There is a fault with the unit and/or the installation	Check and clean trailer plug connection. Please contact REDARC or visit your local auto-electrician for further assistance
	The LED is YELLOW and flashes RED once per second	There is a short circuit somewhere on the brake output line (BLUE wire)	Check all wiring from the unit to the trailer brakes for any wiring faults, including at trailer plug or within brake hubs
	The LED is YELLOW and flashes RED twice per second	There is a short circuit somewhere on the brake light circuit (RED wire)	Check all wiring from the unit to the brake light trigger for any wiring faults
	The LED is YELLOW and flashes RED four times per second	There is a break/open circuit somewhere along the Tow-Pro® Elite's Ground circuit (WHITE wire)	Check all ground connections and associated wiring for any wiring faults
	The LED is BLUE and flashes RED once per second when vehicles brake not applied	The unit has detected that the Remote Cable is faulty, or it is in calibration mode with a permanent input on the brake light trigger	Check the Remote cable is fully plugged in, otherwise replace; check red wire has 0 V when vehicle brake is not applied

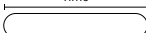
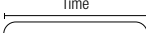
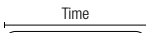
LED Sequence	Symptom/Description	Possible Cause	Suggested Action
	The LED is flashing RED	The unit has detected an internal fault of your AI-Ko iQ7 hydraulic/ pneumatic system There is a voltage drop between the trailer ground and the vehicle ground	Check for faults according to the manual for the AI-Ko iQ7 actuator If you don't have an AI-Ko iQ7, check for suitable wiring on the trailer ground circuit
	The LED is flashing GREEN only whilst braking	Loss of supply power or Circuit Breaker cycling	Check supply (BLACK) wire for good connection & check circuit breaker/fuse not blown and correct value
	The LED is flashing GREEN at any time	Hesitation during connection of BLACK wire possibly causing incomplete startup sequence	Disconnect BLACK wire, wait 1 minute and reconnect BLACK wire to the battery
	The LED is flashing GREEN at any time or only when not braking	Low continuous voltage on brake light (RED) wire	Check that RED wire is connected to a point that is 0 V when the brakes are off and 12 V (or 24 V for Electric Brake installation) with the brakes applied
	Flashing green any time with knob fully CW	The unit is not yet calibrated	Keep driving normally and the unit will calibrate
	The LED is flashing BLUE	The Remote Head cable may be damaged	Replace the cable between the Remote Head and the Main Unit
	The LED is flashing BLUE	The power supply to the unit is not stable	Check the BLACK and WHITE wires for loose connections
	The LED is flashing BLUE	The RED wire is (constantly) at a low voltage	Check the voltage at the RED wire and reassess the connection point if necessary
	The LED flashes an unusual color sequence randomly whilst braking	There is a short circuit on the output (BLUE) wire or the Fuse or Circuit Breaker is overloaded	Check for short circuit on trailer brake (BLUE) circuit, including moving brake swing arms Check that no other devices are running from the same Fuse or Circuit Breaker as the Tow-Pro® Elite
	LED only lights up when braking	The power wire is most likely not connected brake light fuse may have blown	Check supply (BLACK) wire for connection problems and check circuit breaker/fuse is not blown
	The LED is not working at all	There is a bad connection to the trailer	Check the trailer wiring as the unit is not recognizing that a trailer is connected
	The LED is not working at all	There is a bad connection between the Main Unit and Remote Head	Check that the Remote Head cable is correctly plugged in to both the Main Unit and Remote Head

4 PERIODIC MAINTENANCE AND CHECKS

⚠ WARNING

Ensure that your trailer brakes are installed and are operating correctly:

Improperly installed and/or faulty trailer brakes can cause erratic vehicle or trailer behavior with the potential to cause a road accident. For this reason, it is of utmost importance that your trailer braking system be installed/maintained by a qualified installer.

Always check brakes at low speed each time a trailer is attached to your vehicle.

Immediately After Installation (To be done by a qualified Auto-Electrician), Test the installation/vehicle wiring. Testing your vehicle wiring is best done by connecting a test light (max. 21 W filament globe) to the brake output, pushing the manual override and having someone check that the test lamp lights up.

BEFORE EACH TRIP

It is important to ensure that your system is operating correctly before you set out. The following should be checked, along with standard mechanical maintenance, each time you attach your trailer:

- Correct brake light operation on both your vehicle and trailer.
- Correct operation and setting of the electric brake controller.
- Correct operation of your trailer brakes.
- Check that your breakaway system is operating correctly and that the breakaway battery is healthy (if applicable).
- Ensure that the tow hitch, and safety chains and weight distribution systems are setup correctly.

PERIODICALLY

It is important to have a qualified technician check the function of your trailer system on a periodic basis to ensure that everything is operating correctly. REDARC recommend that you visit a qualified technician before the beginning of each holiday season to ensure that any towing aids or systems are working correctly.

OTHER CONSIDERATIONS

Please consider these points whilst towing a trailer:

- Ensure that your vehicle is capable of towing the trailer.
- Ensure that you adjust your driving style to allow more time to change lanes and brake.
- Always remember that your electric brake controller is designed to supplement your vehicle brakes; do NOT use the Tow-Pro® Elite manual override in place of your vehicle foot brake.
- REDARC recommend professional towing training before attempting to tow a trailer.

5 FREQUENTLY ASKED QUESTIONS

The LED is flashing Blue/Green, what does this mean?

A Blue/Green flash sequence indicates that the unit is in the process of calibration, as the unit becomes more confident in its calibration the Blue will appear for longer. Continue driving and eventually this will turn to a solid Blue.

How do I change from Proportional to User Controlled mode?

See [Section 3.3.3, "Changing Modes" \(page 19\)](#).

Will it work with electric over hydraulic trailer brakes?

Yes, see [Section 2.2.3, "Wiring — Electric/Hydraulic Brakes" \(page 12\)](#).

Can it be mounted in any orientation? How do I set the levelling of the main unit?

Yes, the unit can be installed inside the vehicle at any angle, provided it is firmly secured and in a location which allows access to the intended remote head location. See ["Mounting the main unit" on page 9](#), ["Mounting the Remote Head" on page 14](#) and ["Mounting the Remote Head on a Dash or Console Panel" on page 15](#) for more information.

My trailer is 3.5 tonnes fully loaded; Is the Tow-Pro® Elite strong enough to stop that much weight safely?

The controller is capable of supplying 3-axle setups at 12 V or 24 V inputs up to the maximum rated braking ability of the brakes. You must also ensure that your trailer brakes are adequate for the trailer load.

Can the remote head cable be extended?

No, the remote head cable is not a standard cable and REDARC recommend not to cut and extend the supplied cable. REDARC have a range of non-standard cable lengths available on our website.

Can the braking level of the manual over-ride be adjusted?

Yes, the manual override can be adjusted whilst it is being applied by turning the gain control knob. For more information on manual override, see [Section 3.2 on page 15](#).

Will my trailer brakes work while I am reversing?

The Tow-Pro® Elite is designed to apply the trailer brakes whether the vehicle is travelling forward or in reverse. The effectiveness of the brake application in reverse will depend on the mechanical design of your particular electric brake system.

I have a 2 axle trailer, is the Tow-Pro® Elite suitable for my trailer?

Yes, the Tow-Pro® Elite is designed to operate up to 3-axle trailers.

I lost the knob/nut/bezel, where can I get one?

The knob, nut or bezel can be purchased as spare parts.

Can I connect the Tow-Pro through my cigarette lighter socket?

No, as most 'power sockets' are rated around 10 A which is insufficient to power trailer brakes and stop lamps circuits. In addition, these outlets may not be powered continuously.

6 FCC DECLARATION

This device complies with part 15 of the FCC Rules. Operation is subject to the following two conditions: (1) This device may not cause harmful interference, and (2) this device must accept any interference received, including interference that may cause undesired operation

Note: This equipment has been tested and found to comply with the limits for a Class B digital device, pursuant to part 15 of the FCC Rules. These limits are designed to provide reasonable protection against harmful interference in a residential installation. This equipment generates, uses and can radiate radio frequency energy and, if not installed and used in accordance with the instructions, may cause harmful interference to radio communications. However, there is no guarantee that interference will not occur in a particular installation. If this equipment does cause harmful interference to radio or television reception, which can be determined by turning the equipment off and on, the user is encouraged to try to correct the interference by one or more of the following measures:

- Reorient or relocate the receiving antenna.
- Increase the separation between the equipment and receiver.
- Connect the equipment into an outlet on a circuit different from that to which the receiver is connected.
- Consult the dealer or an experienced radio/TV technician for help.

7 WARRANTY

LIMITED WARRANTY

For full warranty terms and conditions, visit the Warranty page of the REDARC website. Refer to the web address and contact details applicable to your region.

Australia, New Zealand & Europe

www.redarc.com.au/warranty

REDARC Electronics Pty Ltd
23 Brodie Road (North),
Lonsdale SA 5160
Australia

Australia +61 8 8322 4848
New Zealand +64-9-222-1024
UK & Europe +44 (0)20 3930 8109

North America

www.redarcelectronics.com/warranty

REDARC Corporation
c/o Shallco, Inc.
308 Component Dr.
Smithfield, NC 27577
USA

USA +1 (704) 247-5150
Canada +1 (604) 260-5512
Mexico +52 (558) 526-2898

CHECKING THE PRODUCT SERIAL NUMBER

The Product Serial Number is located on the side of the Main Unit and on the side of the Product Packaging.

The Serial Number Label contains the Part Number (circled in BLUE) and the Serial Number (circled in RED).

The first 4 digits of the serial number indicate the YEAR and MONTH of manufacture, in the format YYMM.

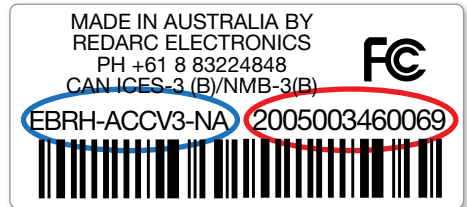
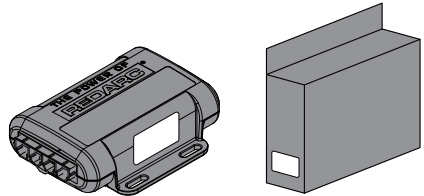

CONTACT

Tech Support 1300 REDARC (1300-733-272)

Australia +61 8 8322 4848

New Zealand +64 9 222 1024

UK & Europe +44 (0)20 3930 8109

redarc.com.au

USA +1 (704) 247-5150

Canada +1 (604) 260-5512

Mexico +52 (558) 526-2898

redarcelectronics.com

THE POWER OF

REDARC[®]