

THE POWER OF

**REDARC**<sup>®</sup>

# TVMS Rogue

12 V 40 A Control and Distribution Module

MODEL:

■ **TVMS1240**

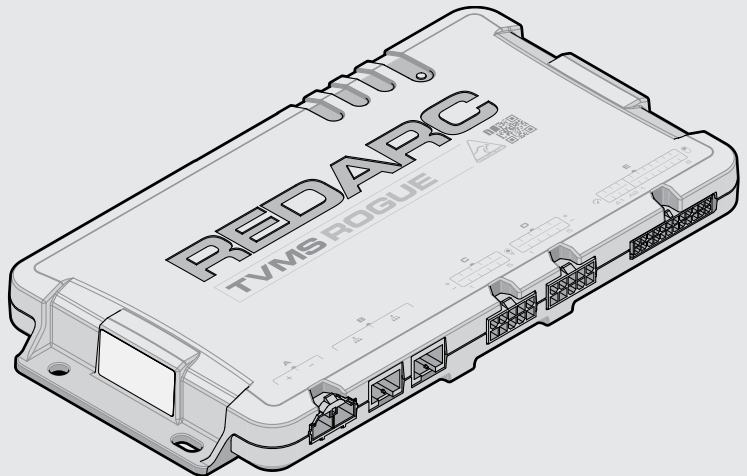

# TVMS ROGUE

The REDARC TVMS Rogue is a Total Vehicle Management System that allows the centralised control and monitoring of multiple on-board devices in a 4x4, caravan, camper trailer, or motorhome. When combined with a Display (REDARC DISP4300) the TVMS Rogue can be configured and controlled wirelessly using your smartphone via Bluetooth® wireless technology.

The REDARC TVMS Rogue can be installed as the central hub of a REDARC RedVision® ecosystem and can connect to other components of the RedVision® ecosystem including Battery Chargers and Battery Management Systems (BMS).

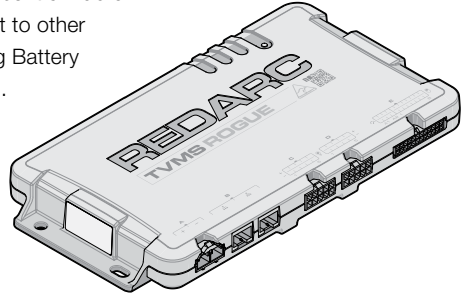

**GET THE FREE  
CONFIGURATOR APP**



**Configure** the settings of your TVMS Rogue using your smartphone via Bluetooth®.



**GET THE FREE  
REDVISION® APP**

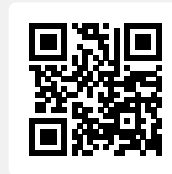

**Monitor and control** your RedVision® System using your smartphone via Bluetooth®.

The RedVision® App and the Configurator App and their interactions with the TVMS Rogue have not been tested on all smartphone models. Visit the application pages within each App store to view compatibility details.

# CONTENTS

<b>WARNINGS AND SAFETY INSTRUCTIONS</b> .....	<b>4</b>
<b>OVERVIEW</b> .....	<b>6</b>
System Example .....	7
Kit Contents .....	8
Parts of the Main Unit .....	9
Display Compatibility .....	10
Wiring Diagram — Basic Install .....	10
Wiring Diagram — with a Manager .....	11
<b>SYSTEM PLANNING</b> .....	<b>12</b>
<b>INSTALLATION — MOUNTING</b> .....	<b>13</b>
Mounting Hardware .....	13
Mounting Location .....	14
Mounting Clearances .....	15
Mounting in Enclosed Spaces .....	15
Mounting Steps .....	16
<b>INSTALLATION — WIRING</b> .....	<b>17</b>
Wiring Parts .....	17
Order of Connections .....	18
Output Wiring (C/D) .....	19
Sensor Input Wiring (E A1–A2) .....	23
Switch Input Wiring (E1–8) .....	24
Power Input Wiring (A) .....	27
CAN Bus Connection (B) .....	30
Strain-Relief and Cable Management .....	32
<b>SYSTEM CONFIGURATION</b> .....	<b>34</b>
Get the RedVision® Configurator App .....	34
Turn Off Display Key Sounds .....	34
Pair the Configurator App to the Display .....	35
Edit a Configuration .....	36
Program the Display .....	36
End-User Lockout .....	37
<b>SYSTEM TESTING &amp; OPERATION</b> .....	<b>38</b>
Get the RedVision® App .....	38
Pair the RedVision® App to the Display .....	39
<b>CARE AND MAINTENANCE</b> .....	<b>41</b>
<b>TROUBLESHOOTING</b> .....	<b>41</b>
General Troubleshooting .....	41
Faults .....	42
<b>TECHNICAL SPECIFICATIONS</b> .....	<b>43</b>
General Specifications .....	43
Electrical Specifications .....	44
Thermal Specifications .....	44
Compliance and Standards .....	45
Connector Part Numbers .....	47
Connector Pinouts .....	48
<b>LIMITED WARRANTY</b> .....	<b>50</b>
Checking the Product Serial Number .....	50

# WARNINGS AND SAFETY INSTRUCTIONS

**SAVE THESE INSTRUCTIONS** — this manual contains important safety instructions. Do not operate the system unless you have read and understood this manual. REDARC recommends that the TVMS Rogue be installed by a suitably qualified person. It is the installer's responsibility to ensure that their installation complies with any applicable legal and regulatory requirements.

**Disclaimer:** REDARC accepts no liability for any injury, loss or property damage which may occur from the improper or unsafe installation or use of its products.

## SAFETY MESSAGE CONVENTIONS

Safety messages in this manual include a signal word to indicate the level of the hazard as follows:

**▲ WARNING:** Indicates a potentially hazardous situation which could result in death or serious injury to the operator or to bystanders.

**▲ CAUTION:** Indicates a potentially hazardous situation which may result in moderate or minor injury to the operator or to bystanders.

**NOTICE:** Indicates a situation that may cause equipment damage.

## IMPORTANT SAFETY INSTRUCTIONS

### ▲ WARNING

When using this product, basic precautions should always be followed, including the following:

1. These products should not be used for any medical purposes, life sustaining equipment, safety applications, or any application where equipment failure can cause injury, death, fires or any other hazard.
2. Do NOT put fingers or hands into the product.
3. Do NOT use the TVMS Rogue if damaged or modified. Damaged or modified products may exhibit unpredictable behaviour resulting in fire, explosion or risk of injury.
4. No user serviceable parts inside. Do NOT attempt servicing this product.
5. **Risk of explosive gases:** Working in the vicinity of a battery is dangerous. Batteries may generate explosive gases during normal operation. Prevent flames and sparks, and provide adequate ventilation especially during charging.
6. To reduce risk of battery explosion, follow these instructions and those published by the battery manufacturer and manufacturer of any equipment you intend to use in vicinity of the battery.

## PERSONAL PRECAUTIONS

1. Consider having someone close-by to come to your aid if you are working near a lead-acid battery.
2. Have plenty of fresh water and soap nearby in case battery acid contacts skin, clothing, or eyes.
3. Wear complete eye protection and clothing protection. Avoid touching eyes while working near battery. If battery acid contacts skin or clothing, wash immediately with soap and water. If acid enters eye, immediately flood eye with running cold water for at least 10 minutes and get medical attention immediately.
4. Do NOT drop metal tools onto a vehicle battery. Doing so might cause the battery to spark or might short-circuit the battery or other electrical parts, which may cause an explosion.
5. **NEVER** smoke or allow a spark or flame in vicinity of battery or engine.
6. Remove personal metal items such as rings, bracelets, necklaces, and watches before working with a vehicle battery. A vehicle battery can produce a short-circuit current high enough to weld a ring or the like to metal, causing a severe burn.
7. Have servicing performed by a qualified repair person using only identical replacement parts. This will ensure that the safety of the product is maintained.

- 8. RISK OF FIRE** — Do NOT install this product in the same compartment where flammable substances are stored, such as petrol/gasoline or Liquefied Petroleum Gas (LPG).

Incorrect handling or disassembly/reassembly may result in a risk of fire. Any attempt to disassemble/reassemble the TVMS Rogue, or make unapproved repairs or modifications will void the warranty and the user's authority to operate the TVMS Rogue.

- 9.** DO NOT expose the TVMS Rogue to temperatures beyond the published limits.
- 10.** DO NOT operate the TVMS Rogue beyond the published ratings. Doing so may result in damage to the TVMS Rogue, fire, explosion and burns/personal injury.
- 11.** If any mechanism or part of the TVMS Rogue becomes broken or damaged, discontinue use immediately.
- 12.** When using the REDARC Configurator App, DO NOT configure important vehicle safety features (such as driving lights or power awnings) in such a way that they may turn Off/On unintentionally while the vehicle is in motion.
- 13.** Use suitable Personal Protective Equipment (PPE) when operating power tools.



### **⚠ CAUTION**

- 1.** The system should not be used by persons under the age of 18, or those with reduced physical, sensory or mental capabilities or lack of experience and knowledge unless they are supervised and under instruction.
- 2.** Selecting the wrong cable or fuse size could result in harm to the installer or user and/or damage to the battery or other equipment installed in the system. The installer is responsible for ensuring that the correct cable type and fuse sizes are used when installing the TVMS Rogue.
- 3.** Cabling must be installed in protected areas away from heat sources, sharp objects or over/through parts of the vehicle that move during operation or maintenance. Supplementary protection such as conduit may be required, especially when installing or routing in the engine bay.
- 4.** Do NOT use this product to control safety critical devices or those that could cause harm if operated remotely (for example fume exhaust fans or lifters). Only operate devices with moving parts when you have a clear line of sight to the moving parts.
- 5.** NEVER connect the TVMS Rogue output ground to chassis ground. Either connect the TVMS Rogue output ground to the negative of a load OR connect chassis ground to the negative of a load and leave the TVMS Rogue output ground unconnected.

### **NOTICE**

- 1.** Do NOT parallel the outputs on the Output Loom — it could cause the TVMS Rogue to not function as expected and may trigger a Fault.
- 2.** Do NOT connect computers or IT equipment to R-Bus Network (B) on the TVMS Rogue. This may damage the Main Unit internal components.

## OVERVIEW

**Power Management** — TVMS Rogue can be configured to turn off all channels to avoid excessive discharge of the auxiliary battery.

**RedVision® Plug'n'Play** — Plug and play with REDARC R-Bus systems including Managers and the RedVision® Display.

**Light Dimming** — 10 ×10A outputs with selectable light dimming mode allows dimming of LED lighting from the RedVision® display.

**Easy to Configure** — Easy to configure via the RedVision® display and free Configurator App.

**Easy to Mount** — Compact housing, easy to mount in tight locations with existing tools.

**Measure Tank Levels** — 2 Analogue inputs connect to tank level sensors to measure fresh water, grey water or fuel tanks.

**Wall Switch Inputs** — Allows connection of up to 8 pushbutton or toggle switches to control outputs from anywhere around the vehicle.

**Common Connectors** — Commonly available Molex connectors allow OEMs to easily integrate TVMS Rogue with their wiring loom design.

## WHY USE TVMS ROGUE?

- Integration service provided to OEM's to make the most of the product and our manufacturing experience
- Configurable software to meet the specification of different vehicles
- REDARC reliability, warranty, and after sales service

## CUSTOMER BENEFITS

- Modern, user friendly interface
- Wireless information and control from mobile device
- Easy to understand system layout
- Expandable
- REDARC quality

## OEM BENEFITS

- Feature expandability for vehicle customisation to customer order
- Easily up-sell value add components such as inverters
- Decreased installation time and complexity
- Improved service and support
- Packaged pricing and delivery
- Differentiation against lower cost, lower tech, competitors

## SYSTEM EXAMPLE

Every Output, Sensor and Switch is fully configurable for total customisation for your setup.

Assign unique icons, names and behaviours for every device so you can easily monitor and control the system when you're on the road.

Here is an example configuration for a caravan/travel trailer.



### Outputs 10 x 10A

- Living Room Light
- Bedroom Light
- Awning Light
- Flood Light
- Water Pump
- Inverter (signal only)
- USB and Acc Sockets
- Fridge
- Stereo
- Fans and TV

### Switch Inputs

- Light Switches
- Water Pump Switch
- Ignition Signal

### Sensor Inputs

- Tank Level Sensor 1
- Tank Level Sensor 2

Free REDARC Configurator App



Display and smartphone not included.

# KIT CONTENTS

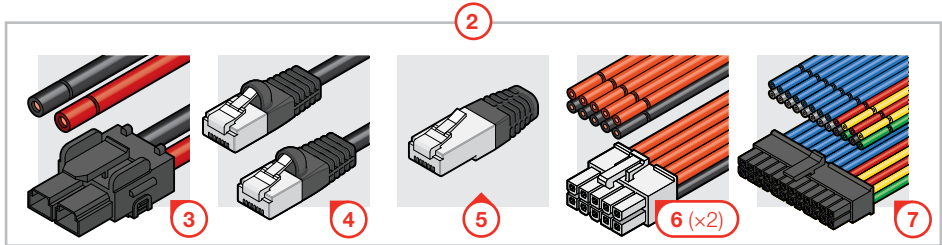
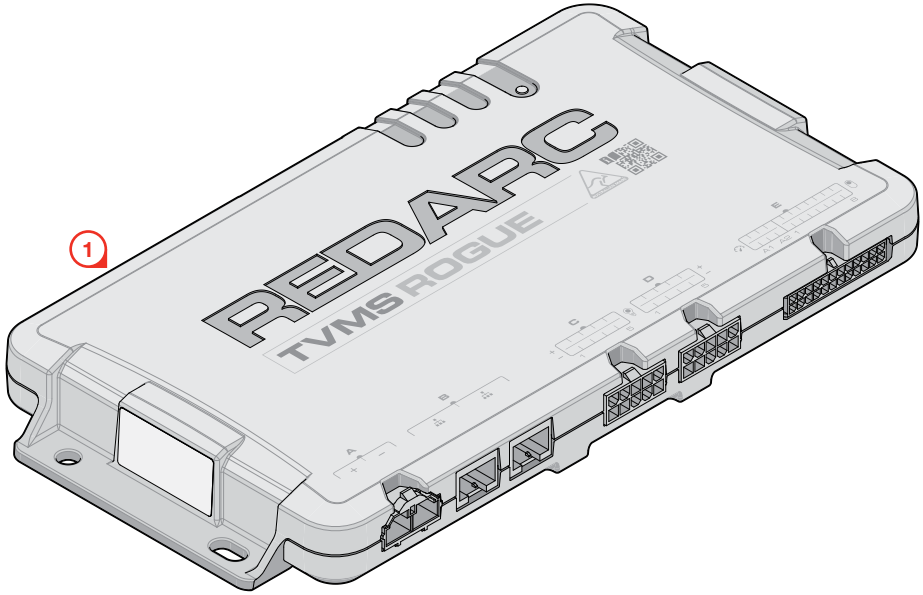

Ref.	Part Description	Qty.
1	TVMS1240 Main Unit	1
2	TVMSWK-001 Wiring Kit	1
3	Power Wiring Loom (12V)	1
4	RJ45 R-Bus Cable, 1 m (3") Black	1
5	RJ45 R-Bus Terminating Resistor	1
6	Output Wiring Loom	2
7	Input Wiring Loom	1



# PARTS OF THE MAIN UNIT

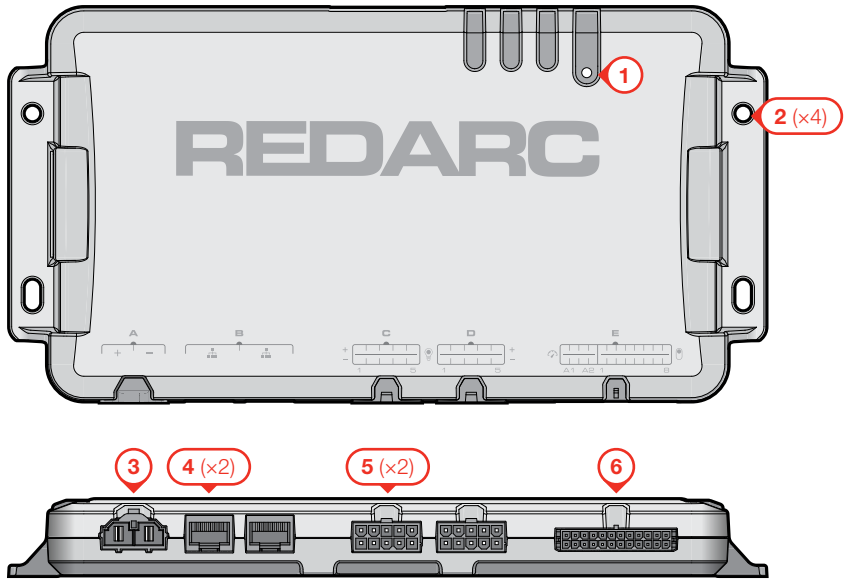

## 1. Status LED

Red LED that illuminates for 5 seconds upon start-up, and also indicates Faults (page 41).

## 2. Mounting Holes (x4)

Fastening points for mounting the Main Unit (page 13).

## 3. Power Input Interface

 **A:** Accepts power from a 12V auxiliary battery (page 27).

## 4. R-Bus Network Interface (x2)

 **B:** Connect RedVision® R-Bus compatible devices such as The Manager and the RedVision® Display (DISP4300).

## 5. Outputs Interface (x2)

 **C / D:** 10A software-fused outputs for powering loads such as a fridge, fans, pumps, and lights with capability for dimming LED lights.

## 6. Inputs Interface

 **E A1/A2:** Sensor inputs (analogue) for connecting compatible tank level sensors (e.g. water level or fuel level), and devices that can measure voltage (e.g. measuring secondary battery voltage).

 **E 1-8:** Switch inputs (digital) for connecting switches that can be configured to remotely turn On/Off devices in the RedVision® system, or can control dimming functionality.

## DISPLAY COMPATIBILITY

TVMS Rogue is only compatible with REDARC Displays (DISP4300) that have a serial number greater than **2207089886-xxxx**.

The display Serial Number label is located on the body of the Display. It can be viewed by removing the display fascia.



## WIRING DIAGRAM – BASIC INSTALL

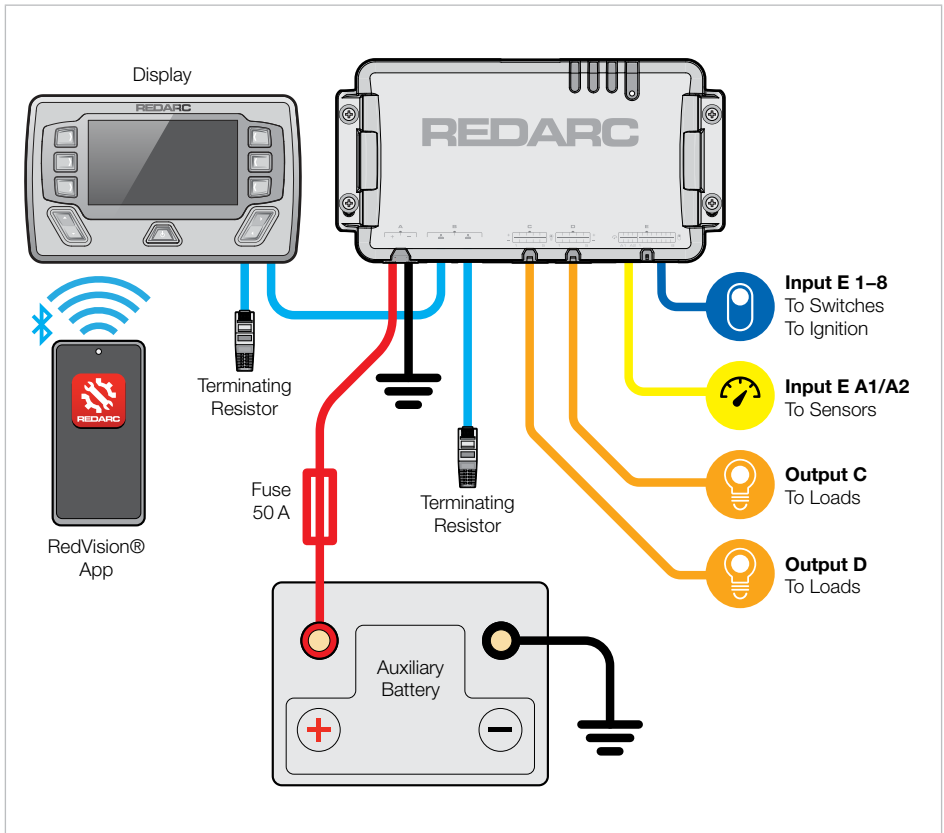

# WIRING DIAGRAM – WITH A MANAGER

Refer to the Instruction Manual supplied with your Manager for detailed Manager mounting and installation instructions, including installation of the Battery Sensor.

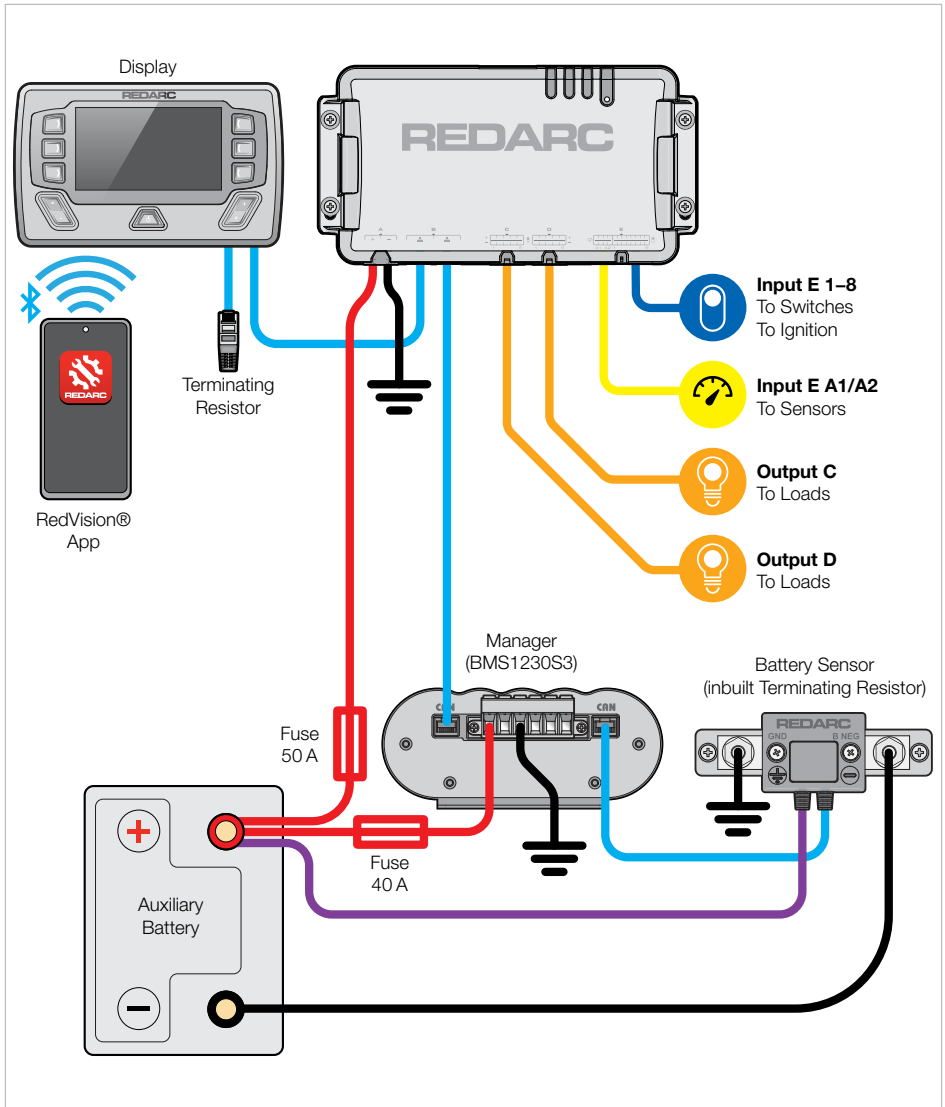

# SYSTEM PLANNING

## **Make a list of devices and plan your connections.**

Prior to beginning Installation, make a list of all components you plan to include in your RedVision® system. Being logical in this stage will make configuration much easier.

Try to connect each Output and its controlling Input on like-numbered channels. For example, a canopy light connected to C3 would be controlled by a corresponding switch connected to E3.

Name channels in a logical way, so that it's easy to find and edit the channels later:

- Name outputs based on their function in a concise way e.g. *Living Room Light, Fridge, Water Pump*.
- Name input switches based on their position in the vehicle e.g. *Entry Switch 1, Bed Switch Left, Outside Switch*. This makes configuring the function of the entry switch much easier than if it was generically called 'Switch 5'.

## **Make sure all system components are compatible.**

Read the installation information and refer to the technical specifications (page 43) before you begin your install to confirm that all components are compatible with your planned system; e.g. components must be 12V nominal, and continuous current must not exceed 10A per output and 40A for the system.

## **Plan the physical arrangement of the system.**

Plan where each component will be mounted so that components that require regular access are in a convenient location.

## **Consider future expansion.**

At some point, you may want to add components to your RedVision® system, or upgrade existing ones. Before installing, think about ways you can future-proof your installation to save time and money later.

# INSTALLATION – MOUNTING

## MOUNTING HARDWARE

When mounting the TVMS Rogue, any fasteners may be used so long as:

- They are suitable for the selected mounting surface and;
- They have a clearance-fit through the mounting holes on the Main Unit.

Using four screws/bolts from M6 (¼") to M4 (#8) with washers is recommended.

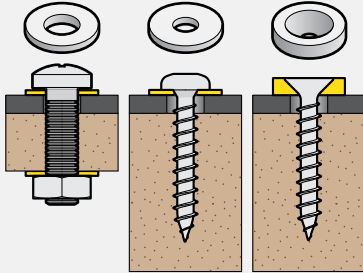

Apply washers.

If using countersunk fasteners, make sure a countersunk washer is used with it to avoid damaging the Mounting Holes.

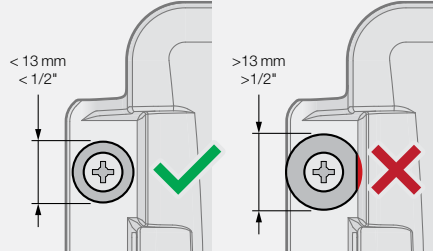

Heads of fasteners and washers must not exceed 13 mm (½") in diameter to avoid deforming/damaging the plastic around the Mounting Holes.

## MOUNTING LOCATION

- Mount as close as possible to the auxiliary battery to avoid voltage drop. Refer to the '[Cable Size Selection Table](#)' ([page 27](#)) for the correct cable size for your cable length.
- Do not mount the Main Unit to moveable panels in your vehicle.
- Do not mount the Main Unit using adhesives or adhesive tape.
- Mount the Main Unit permanently to a surface that has adequate strength and structure to support it when all connectors and wiring are in-place.
- Mount in a location that is cool, i.e. avoid mounting in a full-sun position or next to devices that emit heat. If the published thermal ratings ([page 44](#)) are exceeded, the TVMS Rogue may automatically turn Off some or all outputs.
- Mount in a location that is dry and is not prone to high humidity. Liquid or vapour entering the Main Unit can cause irreparable damage.
- Mount in any orientation except with the connectors facing upwards to prevent condensation/liquids running into the Main Unit. For further advice, see '[Water Ingress Avoidance](#)' ([page 33](#)).
- The mounting surface must be flat and safe to drill — check the reverse side before drilling.

### Mounting orientation

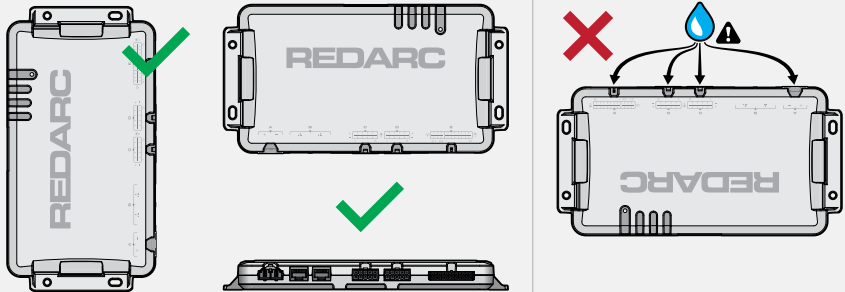

### Mount to a flat surface

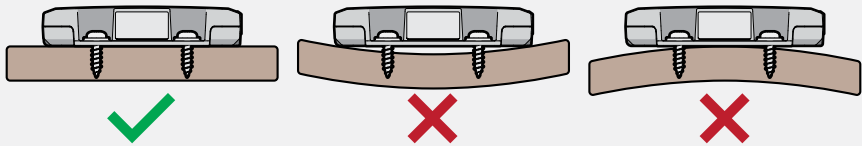

## MOUNTING CLEARANCES

- Leave at least 100 mm (4") of clearance around the connections on the TVMS Rogue for the wiring looms to be connected and disconnected.
- Allow clearance for strain-relief and cable management once wiring is complete. See '[Strain-Relief and Cable Management](#)' (page 32) for further information.
- Make sure the Status LED is easily visible for troubleshooting.
- Allow clearance on all sides of the Main Unit for air flow. For more information, see '[Mounting in Enclosed Spaces](#)'.

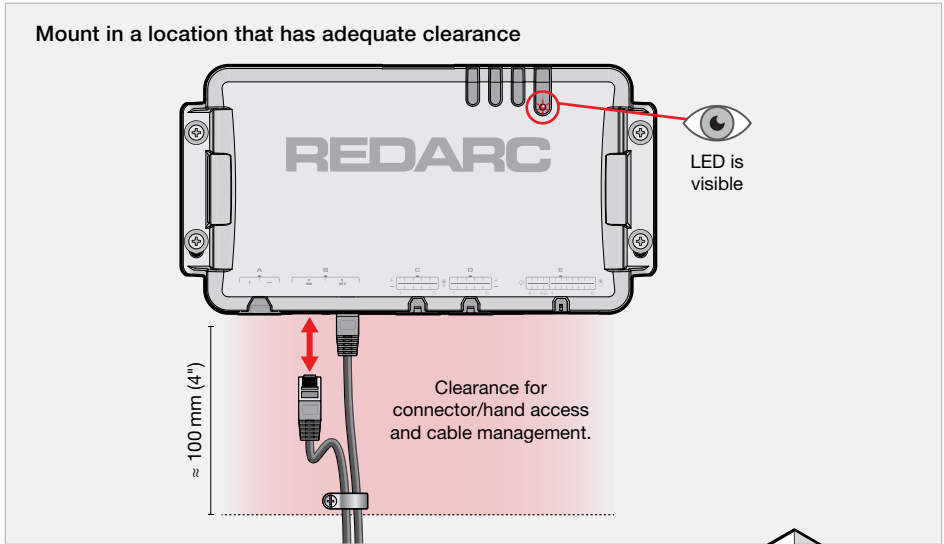

## MOUNTING IN ENCLOSED SPACES

If installing TVMS Rogue in an enclosed space, make sure there is adequate venting. Two vents should ideally be positioned at the top and bottom of the enclosure for cross-flow of air.

Allow at least 50 mm (2") clearance on all sides of the Main Unit for air flow.

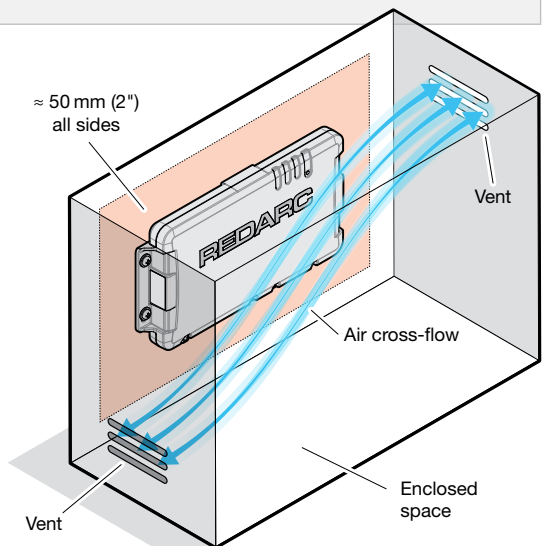

## MOUNTING STEPS

**⚠ WARNING:** Use suitable Personal Protective Equipment (PPE) when operating power tools.



**NOTICE:** Do NOT modify the plastic housing or mounting holes in any way. Modification to the unit will void the warranty.

1. Confirm that the clearances around the TVMS Rogue Main Unit are adequate; see '[Mounting Clearances](#)' (page 15).
2. If clearance/pilot holes need to be drilled, place the TVMS Rogue in its final position and carefully mark the centre of each mounting hole. For centre dimensions of mounting holes, see '[General Specifications](#)' (page 43).
3. Drill the clearance/pilot holes. De-burr the drilled holes and clear away swarf. Touch up any bare metal surfaces that have been exposed with a rust-inhibitor (e.g. primer).
4. Fasten the TVMS Rogue in place, applying a washer in between the fastener and the plastic housing. Do not over-tighten the fasteners, as this could damage the Mounting Holes or plastic housing of the Main Unit.

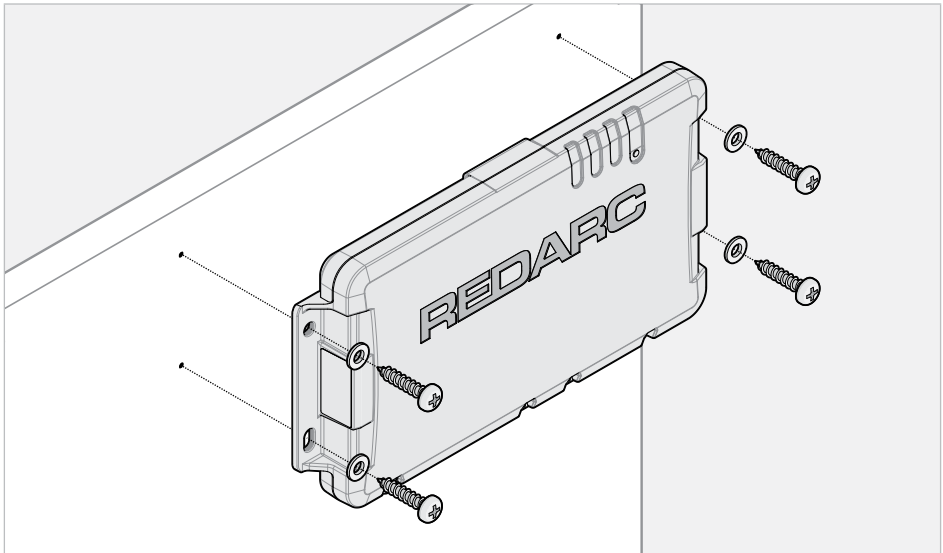



# INSTALLATION – WIRING

**⚠ CAUTION:** Before you begin wiring/connecting your system, read 'Warnings and Safety Instructions' starting on page 4.

## WIRING PARTS

### YOU WILL NEED:

- 1 × TVMS Rogue (TVMS1240 — includes TVMSWK-001 Wiring Kit)
- 50A Midi fuse with fuse holder — REDARC FK50 recommended
- Tools and consumables as needed (see below)

### If your install includes a REDARC Manager, you will also need:

- 40A Midi fuse with fuse holder — REDARC FK40 recommended

## TOOLS

The tools listed may be required for mounting and wiring the TVMS Rogue:

- Screwdriver set
- Spanner set
- Pliers
- Side/Cable cutters
- Ratcheting or Hydraulic crimping tool
- Heat gun
- Soldering Iron

## CONSUMABLES

Components not included with the TVMS Rogue may be required for wiring connections and cable management, including:

- Cable/Wire
- Cable connectors e.g. Butt-splices
- Lugs / Ring terminals
- Electrical tape
- Heat Shrink
- Cable ties
- Conduit / Split tubing
- Fasteners / P-Clips

### ⚠ CAUTION

- Selecting the wrong cable or fuse size could result in harm to the installer or user and/or damage to the battery or other equipment installed in the system. The installer is responsible for ensuring that the correct cable type and fuse sizes are used when installing the TVMS Rogue.
- Wiring must be installed in protected areas away from heat sources and sharp objects. Cables must not be routed over or through moving parts of the vehicle. Additional protection such as conduit may be required, especially if routing cables through the engine bay.

## TERMINATING CABLES

### AS A GENERAL GUIDE:

- Always use the correct crimping tools for crimping automotive crimp connectors. Do not use pliers as this may crush/deform the sleeve and wires resulting in a failure-prone connection.
- Avoid using solder sleeves — they are prone to failure if the solder does not run properly.
- Insulate the ends of individual unused wires to prevent them from shorting. DO NOT heatshrink/tape multiple unused wires together as a single bundle. Heatshrink/electrical tape must fully-encapsulate bare wires and be securely shrunk/adhered onto the wires.



### OTHER CONNECTOR TYPES

For wiring of the Input and Output Looms, a range of connector types are acceptable provided that a solid connection is made. REDARC recommends the following connection types:

- **Butt-splice crimps** (pre-insulated or standard), or **solder with heatshrink** are readily available options that form a good, permanent connection. Note however, that wires have to be cut and then re-terminated if your wiring needs to be adjusted or upgraded.
- **Insulated bullet or spade crimp connectors** are the recommended non-permanent connectors. They provide a solid electrical connection while still giving you the flexibility to adjust or upgrade your wiring without the need to cut the wires and re-terminate them.

## ORDER OF CONNECTIONS

Ensure all Input and Output connections are correctly wired **before** connecting the Power Input Connector wiring to the 12V auxiliary battery.

## OUTPUT WIRING (C/D)

### Connecting the TVMS Rogue outputs to 12V loads.

The TVMS Rogue outputs can be used for switching a wide variety of devices/loads, then allowing you to monitor and configure them via the RedVision® Display or App. Typical loads include:

- Fridge
- Lighting
- Water Pumps
- Fans
- Television
- Stereo
- Accessories — e.g. charging sockets
- Relays — to support switching/control of loads greater than the 10A limitation of the TVMS Rogue (REDARC RK1260 recommended)
- REDARC Inverters — switching only; not to be used for powering an inverter.

### SELECTING LIGHTS:

- **LED Light** — if you intend to use the dimming capability, check before installing that your chosen LED lighting is dimmer-compatible. Using non-dimmable LEDs can result in flickering and damage to the LED light.
- **Filament/Incandescent Lights** — these are compatible with the TVMS Rogue and are dimmable, however they are not recommended due to their high power consumption. Opt for power efficient lights such as LEDs wherever possible.
- **Compact Fluorescent Lights (CFL)** — most CFL lights are not dimmable, and dimmable versions are not readily available. These are not recommended for dimming applications.

## WIRING TYPICAL LOADS

For connector pinout information, see 'Output Cable Connectors (C/D) Pinouts' (page 48).

Loads/devices will typically be connected in one of the following ways:

- **Hard-wired directly to the Output Loom** – this is ideal for permanently installed devices such as lights in a caravan/travel trailer.
  - **Plugged into an accessory socket that is mounted to the vehicle** – this is ideal for portable devices as they can then be quickly unplugged for moving.
1. Connect the wires from the device (the load) to a numbered pair of Orange and Black wires on the Output Wiring Loom (at **C or D**).
  2. Insulate the ends of individual unused wires to prevent them from shorting. **DO NOT** heatshrink/ tape multiple unused wires together as a single bundle.
  3. Configure via the REDARC Configurator App.

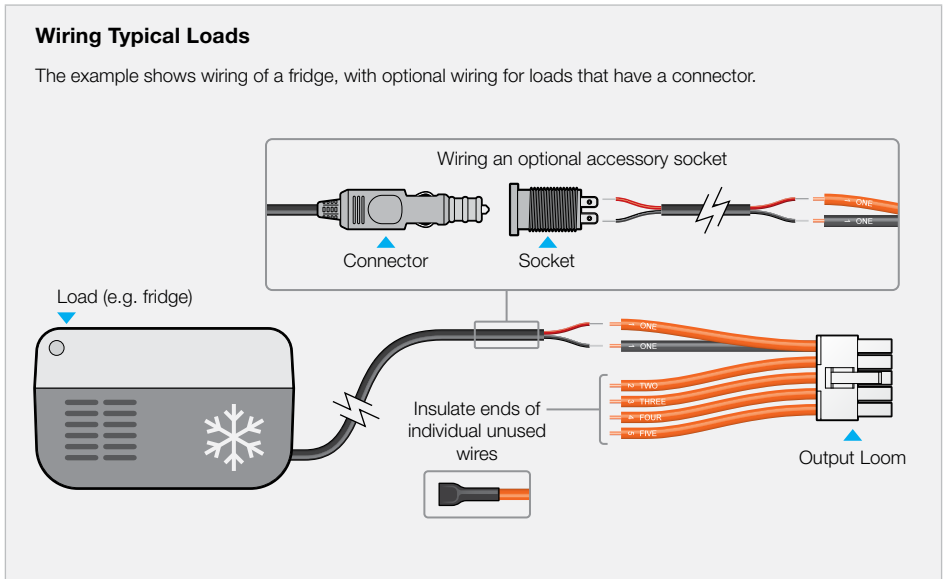

### ⚠ CAUTION

- Power sources must NOT be connected to the TVMS Rogue Outputs (C/D). Connecting batteries or power supplies to the Outputs (C/D) may damage the TVMS Rogue.
- NEVER connect the TVMS Rogue output ground to chassis ground. Either connect the TVMS Rogue output ground to the negative of a load OR connect chassis ground to the negative of a load and leave the TVMS Rogue output ground unconnected.
- The TVMS Rogue outputs are internally software-fused at 10A. If wiring to a circuit that has a lower current capability e.g. thinner wire, a suitable fuse must be fitted to protect the circuit and prevent damage/fire.

**NOTICE:** Do NOT parallel the outputs on the Output Loom to try to increase the output current rating. This capability is NOT supported and may trigger a Fault.

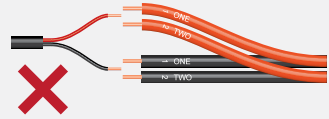

## WIRING SWITCH RELAYS

Installing a relay allows the 10A rated Outputs to support switching and control of loads greater than 10A. The REDARC RK1260 Relay Kit is recommended.

### Wiring Switch Relays

Using a Relay (RK1260) to wire a switched 50A Anderson plug outlet from an auxiliary battery.

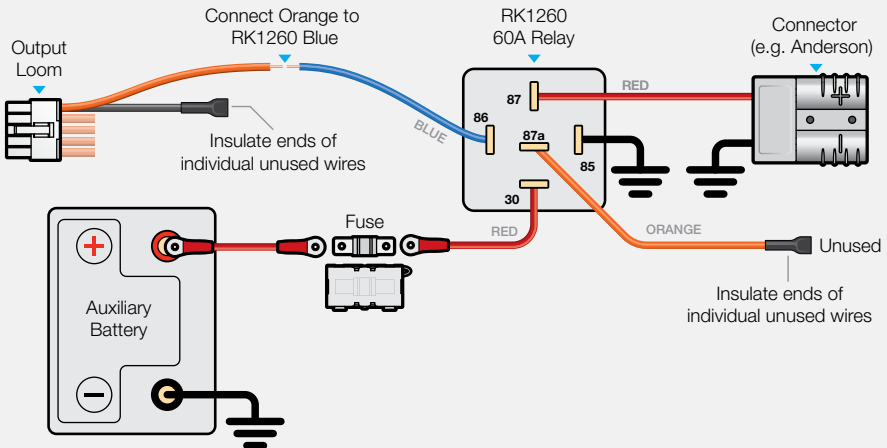

## WIRING TO SWITCH A REDARC INVERTER

The Remote Control Terminal on REDARC Inverters allows an Output from the TVMS Rogue to act as an On/Off switch for the inverter.

**Note:** TVMS Rogue DOES NOT power the inverter.

Connecting a positive (Orange) Output wire to the ENB+ terminal on the inverter provides a switchable +12V signal to the inverter.

When connecting a REDARC Inverter, read the Instruction Manual supplied with the Inverter before making any connections, and make sure the TVMS Rogue and the REDARC inverter share a common ground.

1. Wire the inverter as per the instructions supplied with your inverter. This includes all power connections which are NOT made to the TVMS Rogue.
2. Connect a wire from the inverter **ENB+** to an Orange wire on the Output Wiring Loom (at **C or D**).
3. Insulate the end of the unused, like-numbered Black wire to prevent it from shorting.
4. Configure via the REDARC Configurator App.

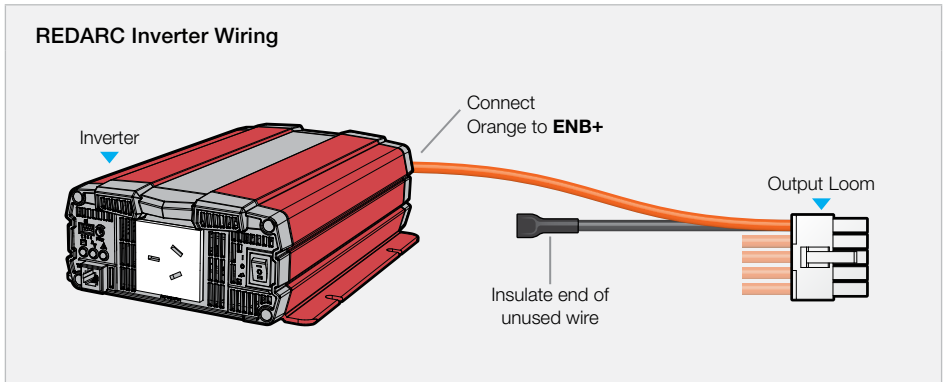

## SENSOR INPUT WIRING (E A1 –A2)

Connecting the TVMS Rogue to analogue sensors.

### TANK LEVEL SENSORS

Tank level sensors can be connected to the TVMS Rogue for measuring tank levels including grey water or clean water tanks. Not all tank level sensors are compatible with TVMS Rogue, so check compatibility before purchasing. Float sensors are recommended because they are readily available and have simple two-wire installation.

### TANK LEVEL SENSOR WIRING

For connector pinout information, see 'Input Cable Connector (E) Pinouts', 'Sensors' (page 49).

1. Connect the wires from the tank-level sensor to a numbered pair of Yellow and Green wires on the Input Wiring Loom (at **E A1 or A2**).
2. Insulate the ends of individual unused wires (like-numbered Red and Black wires) to prevent them from shorting. DO NOT heatshrink/tape multiple unused wires together as a single bundle.
3. Configure via the REDARC Configurator App.

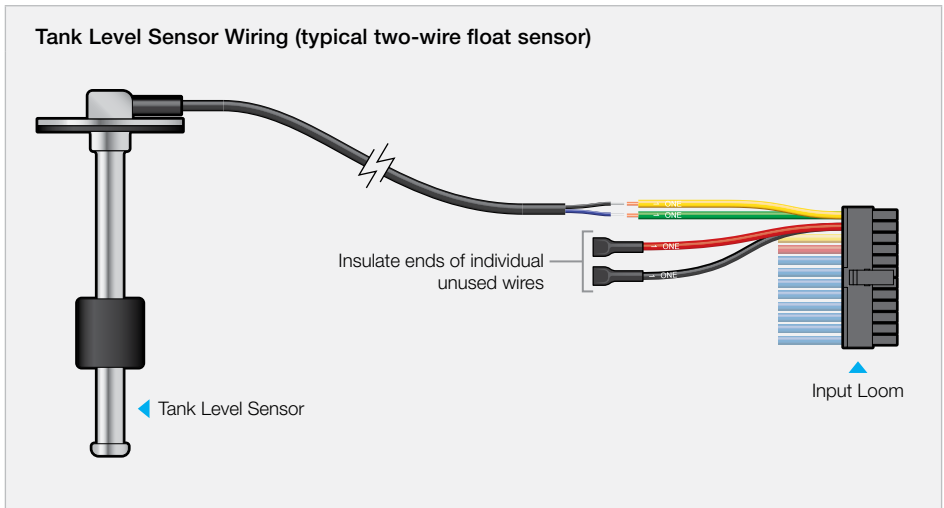

## SWITCH INPUT WIRING (E1–8)

### Connecting the TVMS Rogue to switches.

The TVMS Rogue has eight digital inputs that can be configured to switch TVMS Rogue output loads on/off when triggered, for example to turn Off all loads except a fridge when the vehicle ignition is on.

When purchasing switches, consider environmental requirements. For example, switches installed near wet or dusty locations need to be dustproof/waterproof with a suitable IP rating.

### RECOMMENDED SWITCH TYPES:

- **Momentary push button** — for dimming applications, switches with Normally Open (NO) contacts are recommended.
- **Toggle switch** — any clean-contact switches can be used e.g. Single Pole Single Throw (SPST) switches. Normally Open (NO) when in the Off state are recommended to minimise standby power i.e. the switch would be open circuit when the door is closed.
- **Micro switch / Door switch** — any clean-contact switches can be used. Normally Open (NO) when in the Off state are recommended to minimise standby power consumption i.e. the switch would be open circuit when the door is closed.
- **Ignition or Voltage input switch** — these switches can be configured to turn channels Off while driving, e.g. to turn all exterior caravan lights Off when it is being towed.
- **12V Passive Infrared (PIR) sensor switch** — these are motion-detecting switches that can be configured to have a timer-controlled output, e.g. to turn a security light On for a set amount of time before turning it Off again.

**Note:** PIR switches require a power connection (C/D) in addition to the switching connection (E 1–8). Connect the power wire/s on the sensor switch to an Output (at **C or D**) to allow the sensor to be switched On or Off by TVMS Rogue. This is a useful configuration for an externally mounted PIR sensor that activates a security light, because it gives you the ability to temporarily disable it. It also allows you to disable PIR sensors when your system is in storage to prevent discharge of the Auxiliary Battery.

- **Illuminated switches** — choose switches that illuminate when the device it controls is On. Note: Illuminated switches require a power connection (C/D) in addition to the switching connection (E 1–8).



# SWITCH WIRING

## BASIC SWITCHES

For connector pinout information, see 'Input Cable Connector (E) Pinouts', 'Switches' (page 49).

1. Connect the wires from the Switch to a numbered pair of Blue and Grey wires on the Input Wiring Loom (at **E 1-8**).
2. Insulate the ends of individual unused wires to prevent them from shorting. DO NOT heatshrink/ tape multiple unused wires together as a single bundle.
3. Configure via the REDARC Configurator App.

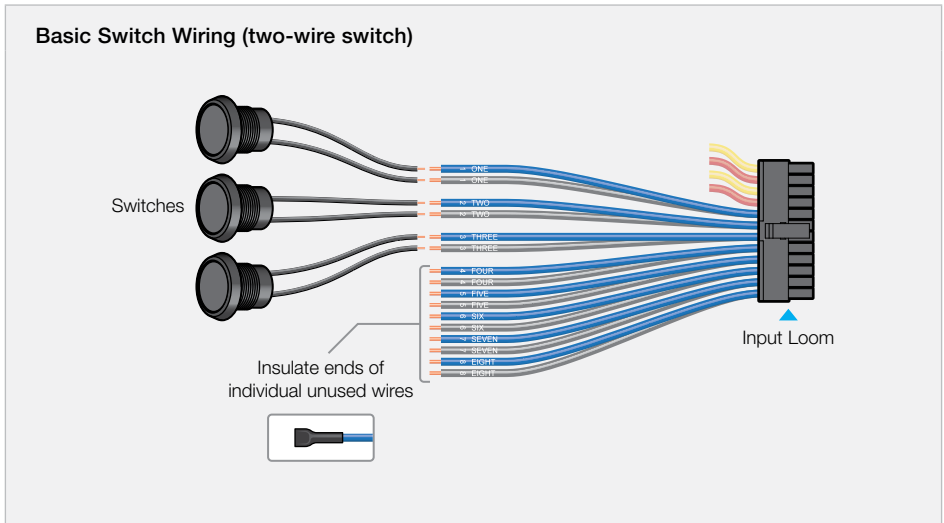

## SWITCHES THAT REQUIRE POWER

Some switches require a power source (e.g. Illuminated switches or PIR sensor switches). To use them, you will need to connect the switch power wire/s to an Output at C or D.

1. Connect the wires from the Switch to a numbered pair of Blue and Grey wires on the Output Wiring Loom.
2. Connect the remaining two wires to a numbered pair on the Output Loom.
3. Insulate the ends of individual unused wires to prevent them from shorting. DO NOT heatshrink/ tape multiple unused wires together as a single bundle.
4. Configure via the REDARC Configurator App.

### Powered Switch Wiring (four-wire switch)

Example shows a 12V PIR sensor switch.

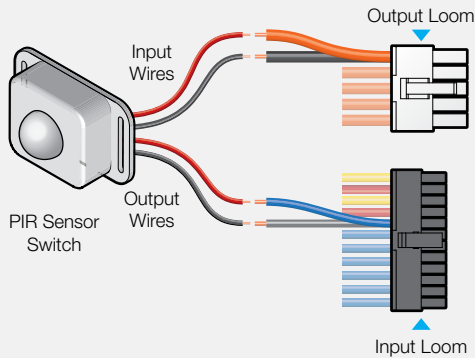

## POWER INPUT WIRING (A)

### Connecting the TVMS Rogue to the auxiliary battery.

Note: Wiring components including fuses, lugs, extension cables and consumables are not supplied.

#### ⚠ CAUTION

- Do NOT modify the Power Wiring Loom cable while it is plugged into the Main Unit.
- The chassis/ground connection should be made away from batteries and fuel lines.
- Ensure all connection surfaces are clean, paint-free, and protected against corrosion.

## POWER INPUT CABLE SIZING

**⚠ CAUTION:** Selecting the wrong cable size could result in harm to the installer or user and/or damage to the battery or other equipment installed in the system.

The installer is responsible for ensuring that all installer-supplied cables are the correct size and type (i.e. has physical performance properties and ratings suitable for the install conditions).

The cable between the TVMS Rogue and auxiliary battery must a large enough gauge to prevent excessive voltage drop over its length. As voltage drop occurs between battery positive and ground, the total Cable Install Length of Positive and Negative cable combined must be considered. Refer to the [Cable Size Selection Table](#) for the correct cable size for your cable length.

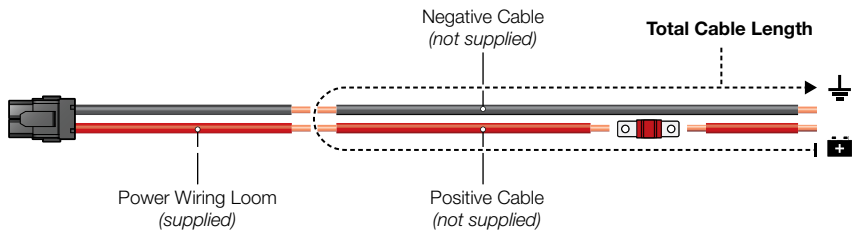

### CABLE SIZE SELECTION TABLE

Cable Install Length* (Positive + Negative Combined)	Recommended Cable Cross Section	Closest Equivalent (AWG/BAE/B&S)
< 2 m (< 6'8")	≥ 7.7 mm <sup>2</sup>	8
2 – 5 m (6'8" – 16')	≥ 13.5 mm <sup>2</sup>	6
5 – 12 m (16' – 40')	≥ 20.2 mm <sup>2</sup>	4

\* **Cable Install Length** refers to the total length of the cables (positive and negative combined) from the auxiliary battery positive terminal to the grounding point.

## FUSING

A **50A MIDI fuse** is required to protect the Power Input cable.

When installing MIDI Fuses, make sure that the nuts securing the fuse and cable lug are tight to avoid high resistance connections.

This fuse should be mounted within 150 mm (6") of the auxiliary battery positive terminal.

**⚠ CAUTION:** Selecting the wrong fuse size could result in harm to the installer or user and/or damage to the battery or other equipment installed in the system. The installer is responsible for ensuring that the correct fuse sizes are used when installing the TVMS Rogue.

MIDI Fuse and Fuse Holder

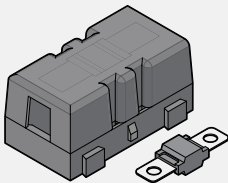

MIDI Fuse Assembly

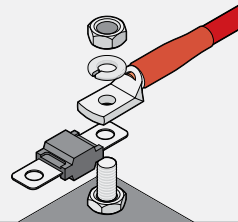

## FUSE TYPES TO AVOID

**Avoid self-resetting circuit breakers** as they may trip prematurely due to the heat generated by the current flowing through the cables.

**Avoid blade type fuses** as they can result in a high resistance connection which causes excess heat and may damage the fuse holder and/or the wiring.

## JOINING/EXTENDING CABLES

The TVMS Rogue Power Input has heavy gauge cables that require good, low resistance joints that will not degrade over time. For extending cables, REDARC recommends a properly crimped splice connection that is covered with heat shrink.

**⚠ CAUTION:** Failure to make a good reliable connection may result in breakdown of the wire insulation and cause a short circuit or potentially a fire.

## TERMINATING CABLES

Lugs are recommended for connecting the Power Wiring Loom to the Midi Fuse, auxiliary battery, and grounding point. Always select lugs that are the correct size for both the cable gauge and stud diameter at the connection point.

## POWER INPUT CABLE WIRING

Before you begin, purchase the correct cable size needed for your installation (refer to 'Power Input Cable Sizing' (page 27). **Note:** Poor quality cable can degrade over time when exposed to high temperatures (such as in an engine bay). Make sure you purchase good-quality cable with a suitable temperature rating for your installation.

For connector pinout information, see 'Power Cable Connector (A) Pinouts' (page 48).

1. Make sure the Power Wiring Loom is disconnected from the Main Unit.
2. Place the Auxiliary Battery and TVMS Rogue Main Unit in their final positions. Run the cables and then trim or extend them as needed — refer to 'Joining/Extending Cables' (page 28).
3. Connect the Red Cable (+) of the TVMS Rogue Power Wiring Loom to the Auxiliary Battery positive terminal. Fuse the Cable to 50 A (fuse not supplied). Position the Fuse as close to the Auxiliary Battery as possible, ideally no more than 150 mm (6") away.
4. Connect the Black Cable of the Power Wiring Loom (negative/ground) to either of the following:
  - Ground (i.e. a vehicle chassis ground stud)
  - The GND ( $\pm$ ) terminal of the Manager's Battery Sensor (not supplied — refer to the instruction manual supplied with the Manager)

**When all other wiring of Outputs (C/D) and Inputs (E) is complete**, plug the Power Wiring Loom into the Power Input interface (A) on the Main Unit.

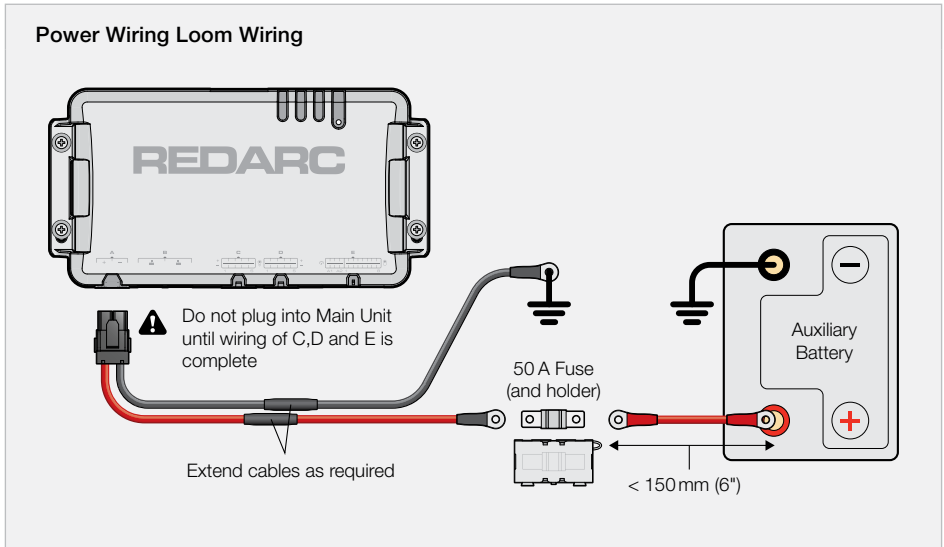

## CAN BUS CONNECTION (B)

Connecting the TVMS Rogue the RedVision system.

**NOTICE:** Do not connect computers or IT equipment to R-Bus Network (B) on the TVMS Rogue. This may damage the Main Unit internal components.

### CAN BUS CONNECTION STEPS

*Note: The RedVision® Display (DISP4300) is not supplied.*

1. Connect the supplied RJ45 Cable between R-Bus Network interface (B) on the Main Unit and the interface in the rear of the Display (DISP4300).
2. Connect the Terminating Resistor supplied with Display (DISP4300) to the any unused interface in the rear of the Display.
3. Connect the Terminating Resistor supplied with the TVMS Rogue to the unused interface (at B) on the Main Unit. This will complete the CAN Bus daisy-chain.

**If your installation includes a Manager**, refer to the Manger product manual for CAN Bus connection instructions.

#### CAN Bus connection to the Display

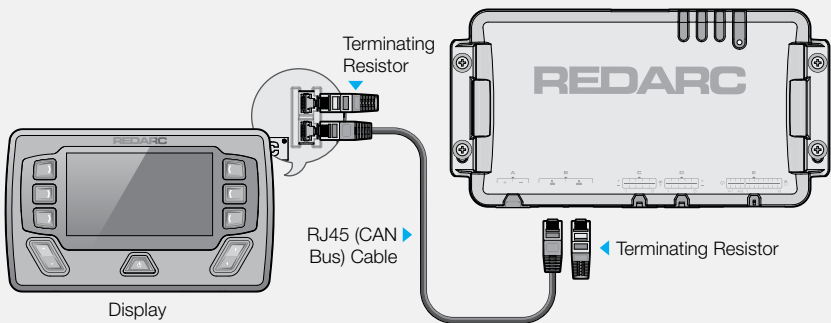

## ABOUT TERMINATING RESISTORS

R-Bus and CAN Bus (Controller Area Network) systems connect devices in a continuous daisy-chain network. Terminating Resistors must be present at each end of the daisy-chain to complete the CAN Bus system.

### Basic Installation

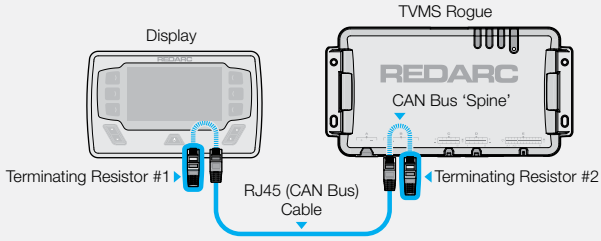

### BMS + Battery Sensor Installation

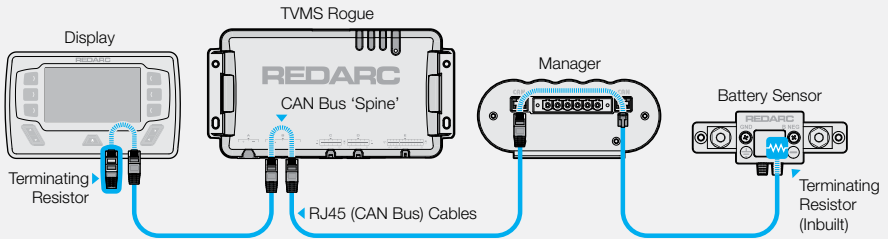

## STRAIN-RELIEF AND CABLE MANAGEMENT

**⚠ CAUTION:** Do not route cables over hot surfaces and sharp objects, or over/through parts of the vehicle that move during operation or maintenance.

### PROTECT AND SECURE THE CABLES

Secure the cables to a fixed point close to the TVMS Rogue Main Unit, within 50 to 150 mm (2" to 6"). Cable ties, cable clips and P-clips are recommended. Flexible conduit can be used to manage and protect bundled cables.

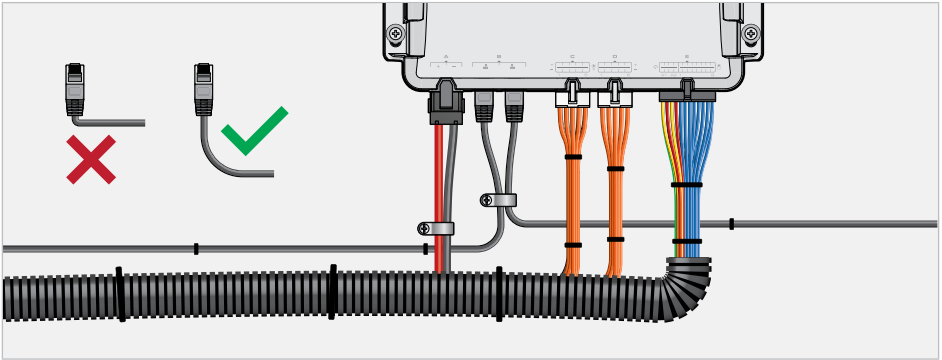

### COUPLING THE LOOM CONNECTORS

Ensure all cables/loom connectors are firmly coupled. Cables must be firmly secured to the vehicle and routed so that they are **not pushing or pulling on the connector interfaces** in the Main Unit. Internal components and connectors may become damaged if they are subjected to repeated strain/vibration due to inadequate cable restraint.

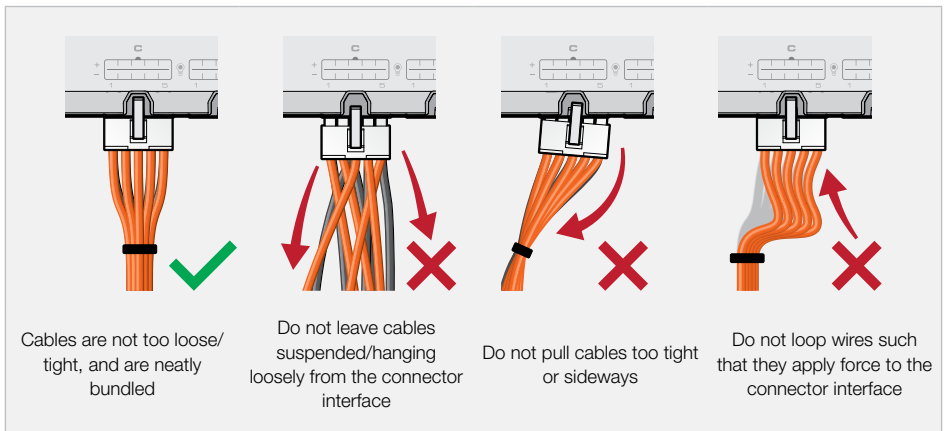



## WATER INGRESS AVOIDANCE

When mounting the Main Unit in any orientation other than with connectors facing downwards (i.e. at the bottom of the unit), **ensure that cables are routed with drip loops**. This is to prevent moisture from running down the cables into the Main Unit.

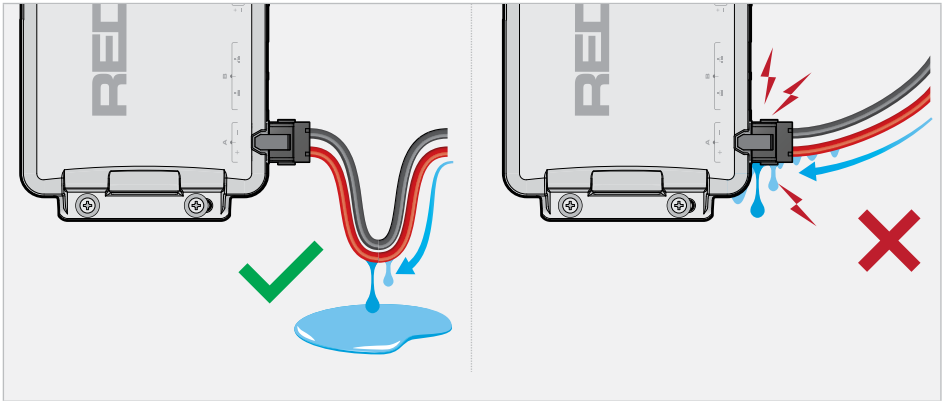

# SYSTEM CONFIGURATION

Once the TVMS Rogue installation is complete, it needs to be configured using the RedVision® Configurator App which connects to the system via the RedVision® Display. The App defines the behaviours of each device in your installation – This is important to make sure the system operates correctly and safely.

## GET THE REDVISION® CONFIGURATOR APP

Download the free REDARC RedVision® Configurator App to Configure the settings of your TVMS Rogue using your smartphone via Bluetooth®.



### GET THE REDVISION® CONFIGURATOR APP

The Configurator App and its interactions with the TVMS Rogue have not been tested on all smartphone models. Visit the application pages within your App store to view compatibility details.





**⚠ WARNING:** When using the REDARC Configurator App, ensure that you DO NOT configure important vehicle safety features (such as lights or mechanical devices) in such a way that they may turn Off/On unintentionally while the vehicle is in motion.

### NOTICE

- The Configurator App allows modification to the core functionality of your RedVision® system. Only use this app if you have read and fully understand all instructions in this manual.
- Ensure that the channel and master override switches are turned Off after use to prevent accidental operation of the channel and flattening of the Auxiliary Battery.

## TURN OFF DISPLAY KEY SOUNDS

1. On the RedVision Display, navigate to **Display Settings**.
2. Press the **Screen Settings** Soft Key (  ).
3. With **Key Sound** selected, press (  ) to toggle key sounds **On/Off**.

## PAIR THE CONFIGURATOR APP TO THE DISPLAY

1. Make sure Bluetooth® is enabled on your smartphone, then open the Configurator App. Note, some smartphones also require Location Services to be enabled.
2. On the RedVision Display, navigate to **Display Settings**.
3. Press the Bluetooth® Soft Key (  ) to display the **Bluetooth Pairing Advertising** screen.

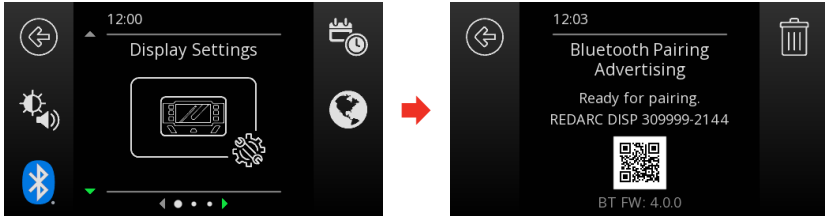

In the **Choose System** screen in the App, select the system that matches the number on the RedVision Display that you want to configure.

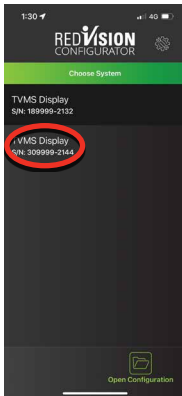

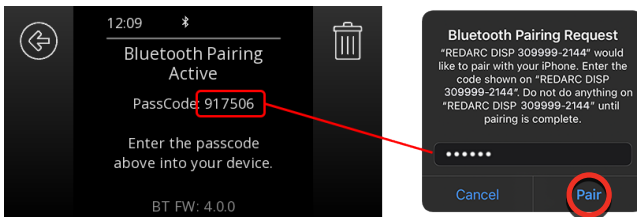

4. Enter the Passcode shown on the Display into the input field, then tap **Pair**.





Once the Display is successfully connected, the Configuration Main Menu in the App will open.

## EDIT A CONFIGURATION

1. Open the RedVision® Configurator App.
2. From the **Choose System** screen, tap **Open Configuration** .
3. From the list, choose the configuration you want to edit.
4. Edit the configuration as required to suit your RedVision system — remember to tap **Save**  each time you make a change.

## PROGRAM THE DISPLAY

Once you have finished editing your configuration, it is applied to the Display via the Program function.

1. Open the RedVision® Configurator App.
2. From the **Choose System** screen, tap **Open Configuration** .
3. From the **Choose Configuration** screen, tap the configuration you want to use to Program the Display. The configuration menu will appear.
4. Tap **Program**  then choose your system from the list. The App will connect to the Display and the programming process will begin.

The process takes approximately 1 to 2 minutes to complete — **DO NOT close the App or use other Apps or functions on your Smartphone** while your RedVision® system is being programmed.

5. When programming is complete, your smartphone will display a confirmation message, and the Display will show the new configuration.

Failed to Program



If the Programming process fails, repeat the steps again before contacting REDARC. If it continues to fail, contact REDARC directly, or your local REDARC Distributor.

## END-USER LOCKOUT



TVMS Rogue allows you to add an Installer PIN (personal identification number) to prevent end-users from changing the Configuration of their RedVision® system. This is to avoid safety hazards if the system is reconfigured in an unsafe way by persons who do not fully understand the system requirements.

**IMPORTANT: By adding an Installer PIN, the saved Configuration cannot be edited without entering a correct the PIN. DO NOT forget the PIN.**

### ADD AN INSTALLER PIN:

1. Open the RedVision® Configurator App.
2. From the **Choose System** screen, tap **Open Configuration**  then select the configuration you want to add an installer PIN to.
3. Tap the gear icon (  ) at the top right of the screen, then select **Add Installer PIN** from the pop-up list.
4. Type a 4 to 8 digit PIN into the **New PIN** field, then retype it in the **Confirm new PIN** field. Tap **Add**.
5. The pin will now have to be input in order to make any changes to the locked configuration.

### REMOVE THE INSTALLER PIN:

1. Open the RedVision® Configurator App.
2. From the **Choose System** screen, tap **Open Configuration**  then select the configuration you want to remove the Installer PIN from.
3. Tap the gear icon (  ) at the top right of the screen, then select **Remove Installer PIN** from the pop-up list.
4. Type the PIN into the **Current PIN** field, then tap **Remove**.

## SYSTEM TESTING & OPERATION

System testing is an important step to confirm the end-user experience of the configured system. Identifying and correcting errors is important before the system is operational and on-the-road.

1. Download and install the RedVision® App.
2. Open the App and check that each connected device appears and functions as intended. This can be confirmed via the RedVision Display, however also testing the install using the RedVision App is strongly recommended.
3. Make sure the device labels and icons are easy to understand.

### GET THE REDVISION® APP

The RedVision® App gives you remote access to TVMS Rogue functions and features including battery level monitoring, system and input source monitoring, system diagnostics, and firmware update notifications.



#### GET THE FREE REDVISION® APP

The RedVision® App and its interactions with the TVMS Rogue have not been tested on all smartphone models. Visit the application pages within each App store for compatibility details.



## PAIR THE REDVISION® APP TO THE DISPLAY

1. Make sure Bluetooth® is enabled on your smartphone, then open the RedVision® App. Note, some smartphones also require Location Services to be enabled.
2. On the RedVision Display, navigate to **Display Settings**.
3. Press the Bluetooth® Soft Key (  ) to display the **Bluetooth Pairing Advertising** screen.



4. In the App, tap the Menu icon (  ). Under the **Devices** heading, tap the Add icon (+).

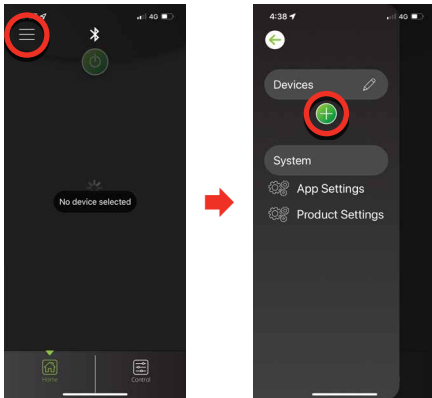

5. Nearby Devices will appear in the list. Select the system that matches the number on the RedVision Display. Read and accept the disclaimer.

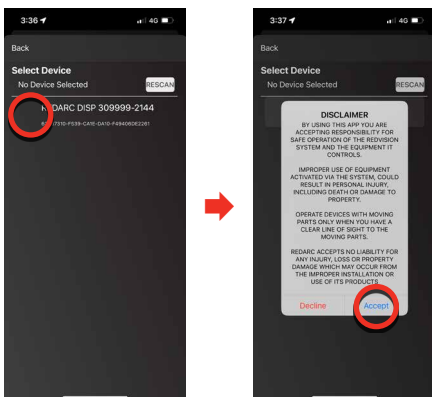

6. Enter the Passcode shown on the Display into the input field, then tap **Pair**.



7. Once your smartphone is successfully paired, the Device Status screen will be displayed. This can take a few minutes.

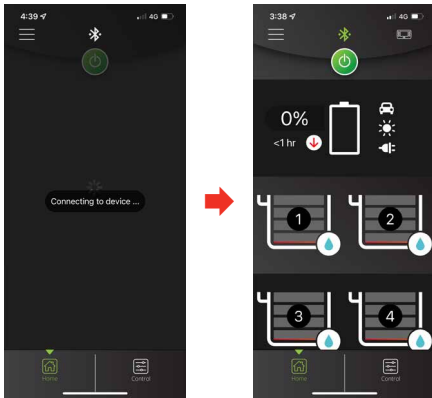

## SUBSEQUENT CONNECTIONS

Once a smartphone has been paired with the RedVision® Display, it will automatically reconnect when the RedVision® App is opened and that Display is selected — Tap the Menu icon (≡) at the top right, then select the Display from the list of Devices.

## PAIR MULTIPLE SMARTPHONES

The RedVision® Display can be paired to multiple smartphones, however it can only be monitored/controlled by one smartphone at a time. When the RedVision® App is minimised on one smartphone, the RedVision® App can be opened on another smartphone and will connect automatically if it has previously been paired.

To pair another smartphone, repeat the steps '[Pair the RedVision® App to the Display](#)' (page 39).



## CARE AND MAINTENANCE

- Do not use solvents, alcohol, or domestic cleaning products to clean the TVMS Rogue. If sand, grit, or dirt accumulate on the Main Unit, wipe it clean with a slightly damp cloth.
- Do not allow the TVMS Rogue to come into contact with corrosive substances.
- Periodically check that all connections are firm, and that all cables are adequately managed. Parts of the system may have moved as a result of repeated vibration, particularly if the vehicle has been travelling on uneven/corrugated road surfaces.

## TROUBLESHOOTING

### GENERAL TROUBLESHOOTING

If you experience any of the listed problems, follow the recommended actions in order until the problem is resolved — all steps may not be needed to resolve the problem.

If the problem persists after completing all of the recommended actions, contact REDARC directly, or your local REDARC Distributor.



#### The Status LED is flashing or solid red

There is a Fault. Refer to [page 41](#) for more detailed information and ways to identify and resolve individual Faults.

#### The RedVision® Display will not connect to the RedVision® App/Configurator App

1. Make sure the smartphone is within 5 metres (16'5") of the RedVision® Display.
2. Check that Bluetooth is enabled on your device.
3. Remove the RedVision® Display 'DISP4300' from the **Devices** list in the RedVision® App and also from the Bluetooth devices list in your smartphone settings.
4. Delete all pairings from the RedVision® Display. See '[Delete All Display Pairings](#)' ([page 41](#)).
5. Unplug all RJ45 R-Bus Cables from the RedVision® Display and then reconnect them again.
6. Turn your smartphone Off and then On.
7. Re-pair the RedVision® Display and smartphone.

#### Delete All Display Pairings

1. On the RedVision Display, navigate to **Display Settings**.
2. Press the Bluetooth® Soft Key (  ) to display the **Bluetooth Pairing Advertising** screen.
3. Press the Delete Soft Key (  ) then press the OK Soft Key (  ) to confirm that you want to clear all paired devices.

## FAULTS

Faults are indicated by the Status LED on the Main Unit:

- **Flashing red** — indicates a Communications Fault
- **Solid red** — indicates an Output Fault

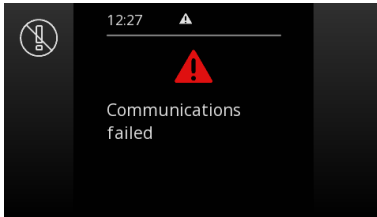

Fault indication on the Display.

## COMMUNICATIONS FAULT RESOLUTION

Communication Faults occur when there is a connection error in the CAN Bus network. In the event of a communications error, the RedVision® App, Configurator App and Display will be unable to communicate with the TVMS Rogue.

To resolve a communications error, complete the following steps, in order, before directly contacting REDARC or your local REDARC Distributor.

1. Check all CAN Bus (RJ45) cables to make sure they are securely connected to the correct connector interface on each RedVision® CAN Bus device in your system.
2. Confirm that terminating resistors are fitted at each end of the CAN Bus 'daisy-chain'.

## OUTPUT FAULT RESOLUTION

In the event of an Output Fault refer to the RedVision® Display or the RedVision® App to identify the cause of the Fault.

Output Faults include:

- Output over current or short circuited
- Device over temperature
- Supply over voltage
- Supply over current

# TECHNICAL SPECIFICATIONS

Specifications subject to change without notice.

## GENERAL SPECIFICATIONS

Main Unit Dimensions	250 × 130 × 25 mm / 9.8" × 5.1" × 1"
Main Unit Weight	≈ 430 g / 1 lb
Warranty	2 years

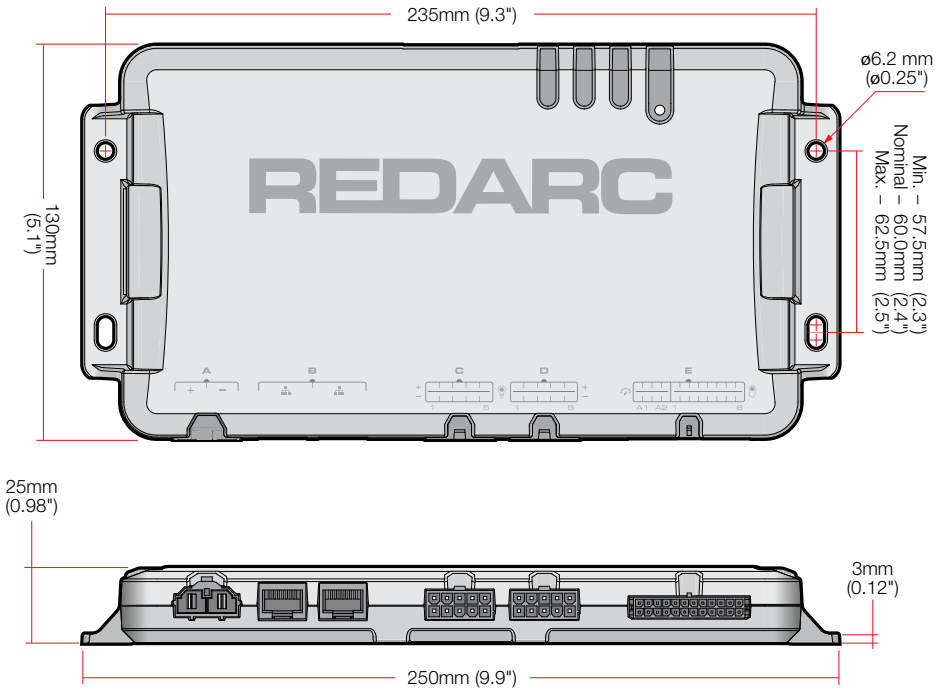

## ELECTRICAL SPECIFICATIONS

### POWER INPUT

Supply Voltage	9–16VDC $\approx$
Supply Current Limit	40A
Connector Housing	Molex 428160212
Connector Contacts	Molex 428150134

### OUTPUT CHANNELS

Number of Channels	10
Channel Current Limit	10A
PWM Dimming Capable	Yes, All Channels
Harness Connector	Molex 039012100
Connector Contacts	Molex 457503111

### PROTECTION

Output Overload Protection	Yes
Output Short Circuit Protection	Yes
Surge Protection	Yes
Reverse Polarity Protection	Yes

### SWITCH INPUT CHANNELS

Number of Switch Inputs	8
Switch Types Supported	Pushbutton or Rocker
Harness Connector	Molex 430252400
Connector Contacts	Molex 430300001

### SENSOR INPUT CHANNELS

Number of Channels	2
Sensor Input Functions	Tank Level Sensing
Sensor Input Modes	Voltage (0–32V), Resistance (0–1000 $\Omega$ )
Multi Point Calibration	Yes, up to 10 points
Sensor Supply Voltage	System Voltage +0V / –2V
Sensor Supply Current	80 mA maximum
Tank Sensors Supported	0–5V, 0.5–4.5V, 240–33 $\Omega$ , 0–190 $\Omega$
Harness Connector	Molex 430252400
Connector Contacts	Molex 430300001

## THERMAL SPECIFICATIONS

Operating Temperature	–20°C to +70°C / –4°F to +158°F
Overtemperature Shutdown	Progressive Load Shedding

# COMPLIANCE AND STANDARDS

## TVMS ROGUE COMPLIANCE



Compliance and Standards listed are for the TVMS Rogue only — *For Regulatory and compliance information for other products described in this manual, refer to the Instruction Manual supplied with that product.*

---

Regulatory	    
Safety	EN 61010.1
Environmental	RoHS and REACH compliant

---

## REDVISION DISPLAY COMPLIANCE

To view regulatory and compliance information on the RedVision® Display, press the Power button (  ) to display the **Power Control** screen, then press the Compliance Soft Key (  ).

## FEDERAL COMMUNICATIONS COMMISSION (FCC) STATEMENT

**Part 15.105 NOTE:** This equipment has been tested and found to comply with the limits for a Class B digital device, pursuant to part 15 of the FCC Rules. These limits are designed to provide reasonable protection against harmful interference in a residential installation. This equipment generates, uses and can radiate radio frequency energy and, if not installed and used in accordance with the instructions, may cause harmful interference to radio communications. However, there is no guarantee that interference will not occur in a particular installation. If this equipment does cause harmful interference to radio or television reception, which can be determined by turning the equipment off and on, the user is encouraged to try to correct the interference by one or more of the following measures:

- Reorient or relocate the receiving antenna.
- Increase the separation between the equipment and receiver.
- Connect the equipment into an outlet on a circuit different from that to which the receiver is connected.
- Consult the dealer or an experienced radio/TV technician for help

This device contains FCC ID: XPNYNINAB1

### Details of the Responsible Party:

REDARC Corporation  
1701 Northwest Highway, Suite 100  
Grapevine TX  
76051  
USA  
Phone: +1 (704) 247 5150

## **INDUSTRY CANADA (IC) COMPLIANCE NOTICE**

This equipment complies with IC RSS-102 radiation exposure limits set forth for an uncontrolled environment.

This equipment should be installed and operated with a minimum distance of 20 cm between the radiator and your body.

### **IC Radiation Exposure Statement:**

This device complies with Industry Canada (IC) license-exempt RSS standard(s). Operation is subject to the following two conditions.

- 1.** This device may not cause interference.
- 2.** This device must accept any interference, including interference that may cause undesired operation of the device.

This device contains IC: 8595A-NINAB1



## CONNECTOR PART NUMBERS

**⚠ CAUTION:** Installer-supplied connector housings and crimp terminals must be the same as those specified.

### POWER INPUT CABLE CONNECTOR

Molex 428160212	10.00 mm Pitch Mini-Fit Sr. Receptacle Housing, Single Row, 2 Circuit, Black	×1	
Molex 428150134	Mini-Fit Sr. Crimp Terminal, Female, 8 AWG, Silver (Ag)	×2	

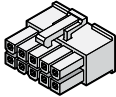
### OUTPUT CABLE CONNECTOR

Molex 039012100	Mini-Fit Jr. Receptacle Housing, Dual Row, 10 Circuits, UL 94V-2, Natural	×2	
Molex 457503111 (reel)	Mini-Fit Plus Crimp Terminal, 16 AWG, Copper (Cu) Alloy, Tin (Sn)	×20	

### INPUT CABLE CONNECTOR

Molex 430252400	Micro-Fit 3.0 Receptacle Housing, Dual Row, 24 Circuits, UL 94V-0, Black	×1	
Molex 430300001 (reel) Molex 430300038**	Micro-Fit 3.0 Crimp Terminal, Female, with Tin Plated Phosphor Bronze Contact, 20–24 AWG	×24	

\*\* Alternative option – the larger 18 AWG contact can be used.

# CONNECTOR PINOUTS

## POWER CABLE CONNECTOR (A) PINOUTS

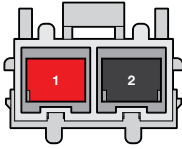

(Wire entry view)

	Channel ID	Terminal	Colour	Function
+	+	1	Red	12V Supply Positive
	-	2	Black	12V Supply Negative

## OUTPUT CABLE CONNECTORS (C/D) PINOUTS

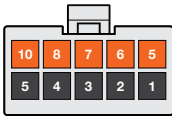

(Wire entry view)

	Channel ID	Terminal	Colour	Function
⚡	C/D 1	10	Orange	Output C/D 1 Positive
		5	Black	Output C/D 1 Negative
	C/D 2	9	Orange	Output C/D 2 Positive
		4	Black	Output C/D 2 Negative
	C/D 3	8	Orange	Output C/D 3 Positive
		3	Black	Output C/D 3 Negative
	C/D 4	7	Orange	Output C/D 4 Positive
		2	Black	Output C/D 4 Negative
	C/D 5	6	Orange	Output C/D 5 Positive
		1	Black	Output C/D 5 Negative



## INPUT CABLE CONNECTOR (E) PINOUTS

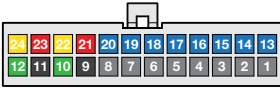

(Wire entry view)

### SENSORS



Channel ID	Terminal	Colour	Function
E A1	24	Yellow	Sensor Input 1 Sense Positive
	12	Green	Sensor Input 1 Sense Common
	23	Red	Sensor Input 1 Supply Positive
	11	Black	Sensor Input 1 Supply Negative
E A2	22	Yellow	Sensor Input 2 Sense Positive
	10	Green	Sensor Input 2 Sense Common
	21	Red	Sensor Input 2 Supply Positive
	9	Black	Sensor Input 2 Supply Negative

### SWITCHES



Channel ID	Terminal	Colour	Function
E1	20	Blue	Switch Input 1 Positive
	8	Grey	Switch Input 1 Common
E2	19	Blue	Switch Input 2 Positive
	7	Grey	Switch Input 2 Common
E3	18	Blue	Switch Input 3 Positive
	6	Grey	Switch Input 3 Common
E4	17	Blue	Switch Input 4 Positive
	5	Grey	Switch Input 4 Common
E5	16	Blue	Switch Input 5 Positive
	4	Grey	Switch Input 5 Common
E6	15	Blue	Switch Input 6 Positive
	3	Grey	Switch Input 6 Common
E7	14	Blue	Switch Input 7 Positive
	2	Grey	Switch Input 7 Common
E8	13	Blue	Switch Input 8 Positive
	1	Grey	Switch Input 8 Common

# LIMITED WARRANTY

For full warranty terms and conditions, visit the Warranty page of the REDARC website:

[www.redarcelectronics.com/warranty](http://www.redarcelectronics.com/warranty)

## Australia, New Zealand & Europe

REDARC Electronics Pty Ltd  
23 Brodie Road (North),  
Lonsdale SA 5160  
Australia

**Australia** +61 8 8322 4848  
**New Zealand** +64 9 222 1024  
**UK & Europe** +44 (0)20 3930 8109

## North America

REDARC Corporation  
c/o Shallco, Inc.  
308 Component Dr.  
Smithfield, NC 27577  
USA

**USA** +1 (704) 247 5150  
**Canada** +1 (604) 260 5512  
**Mexico** +52 (558) 526 2898

# CHECKING THE PRODUCT SERIAL NUMBER

The Product Serial Number is located on the TVMS Rogue Main Unit and on the product packaging.

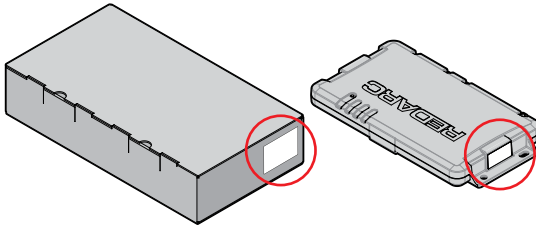

## IMPORTER CONTACT INFORMATION

### UK

Ozparts UK Ltd  
St Helen's House  
King Street  
DE1 3EE Derby  
UK

### Europe

Ozparts Sp. z o. o. Sp. kom.  
Slowackiego 32/5  
87-100 Torun  
Poland

**PATENTS APPLY**

**Australia:** 2021106539

**REDARC Electronics Pty Ltd** | ABN 77 136 785 092 | 23 Brodie Road (North), Lonsdale SA 5160, Australia

Product configuration and technical specifications are subject to change without notice.

Copyright © 2022 REDARC Electronics Pty Ltd. All rights reserved. REDARC® and THE POWER OF REDARC® are trademarks of REDARC Electronics Pty Ltd.

The Bluetooth® word mark and logos are registered trademarks owned by Bluetooth SIG, Inc. and any use of such marks by REDARC Electronics is under license. Other trademarks and trade names are those of their respective owners.

Molex® is a registered trademark of Molex, LLC in the United States of America and may be registered in other countries; all other trademarks listed herein belong to their respective owners.

**Tech Support**

1300 REDARC (1300-733-272)

**Australia**

+61 8 8322 4848

**New Zealand**

+64 9 222 1024

**UK & Europe**

+44 (0)20 3930 8109

**USA**

+1 (704) 247-5150

**Canada**

+1 (604) 260-5512

**Mexico**

+52 (558) 526-2898

**redarcelectronics.com**

THE POWER OF

